



# CAROUSEL DRESS

Sizes 2-20  
with cup sizes A-H

5/8 inch (in) (1.5 cm) seam allowances  
are included on all pattern pieces.

© 2022 Charm Patterns by Gertie.  
Distribution and Commercial Use Prohibited.

## SIZES 2-20 PATTERN SIZE KEY

2	—————
4	- - - - -
6	· · · · ·
8	- · - · -
10	· · - · - ·
12	- · - · - ·
14	· · · · ·
16	- · - · - ·
18	· · · · ·
20	- · - · - ·

## SYMBOL KEY

grainline arrow



match point/  
placement mark

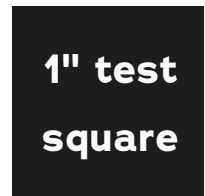

2A  
E

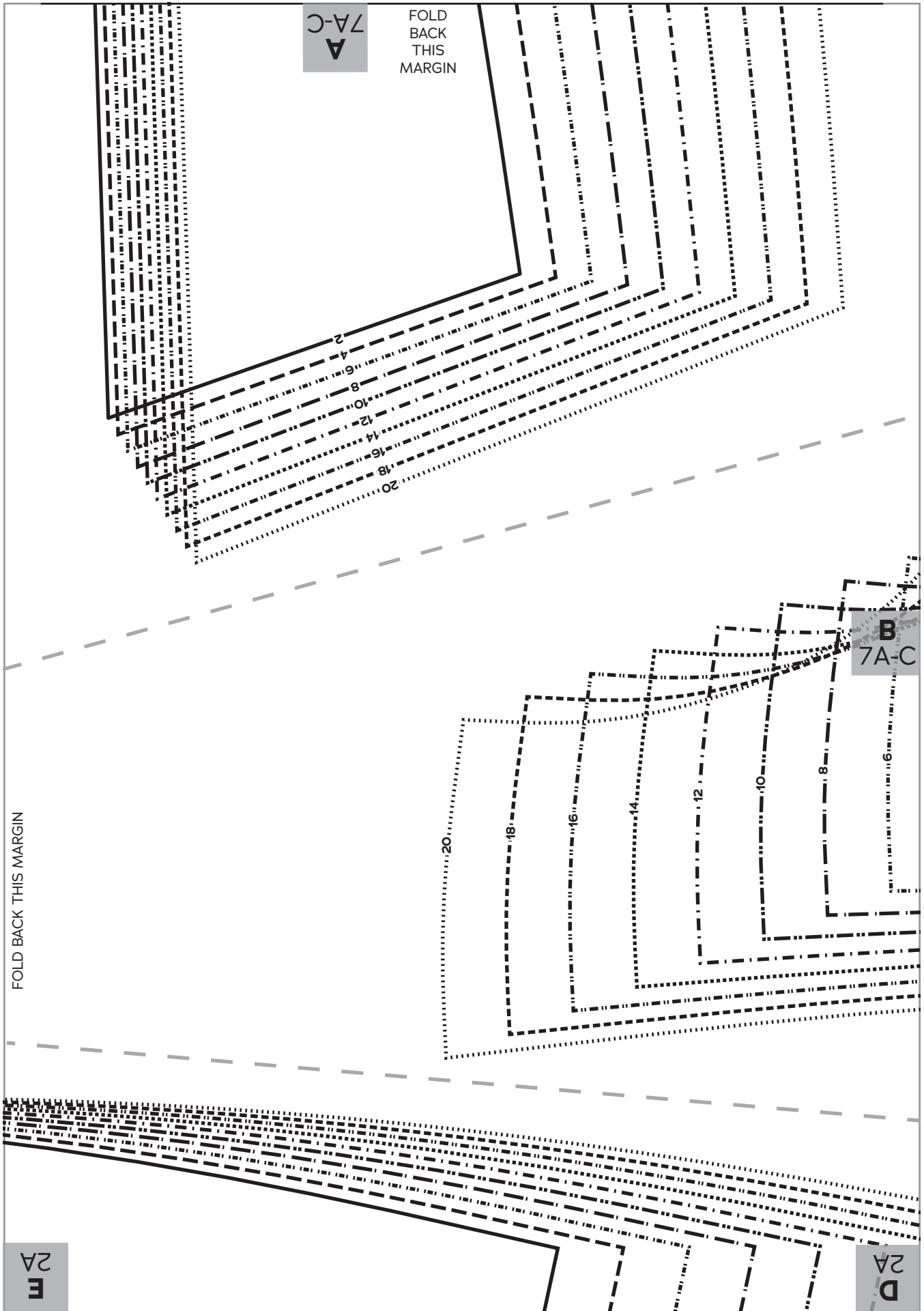

7A-C  
A

FOLD  
BACK  
THIS  
MARGIN

B  
7A-C

FOLD BACK THIS MARGIN

E  
2A

D  
2A

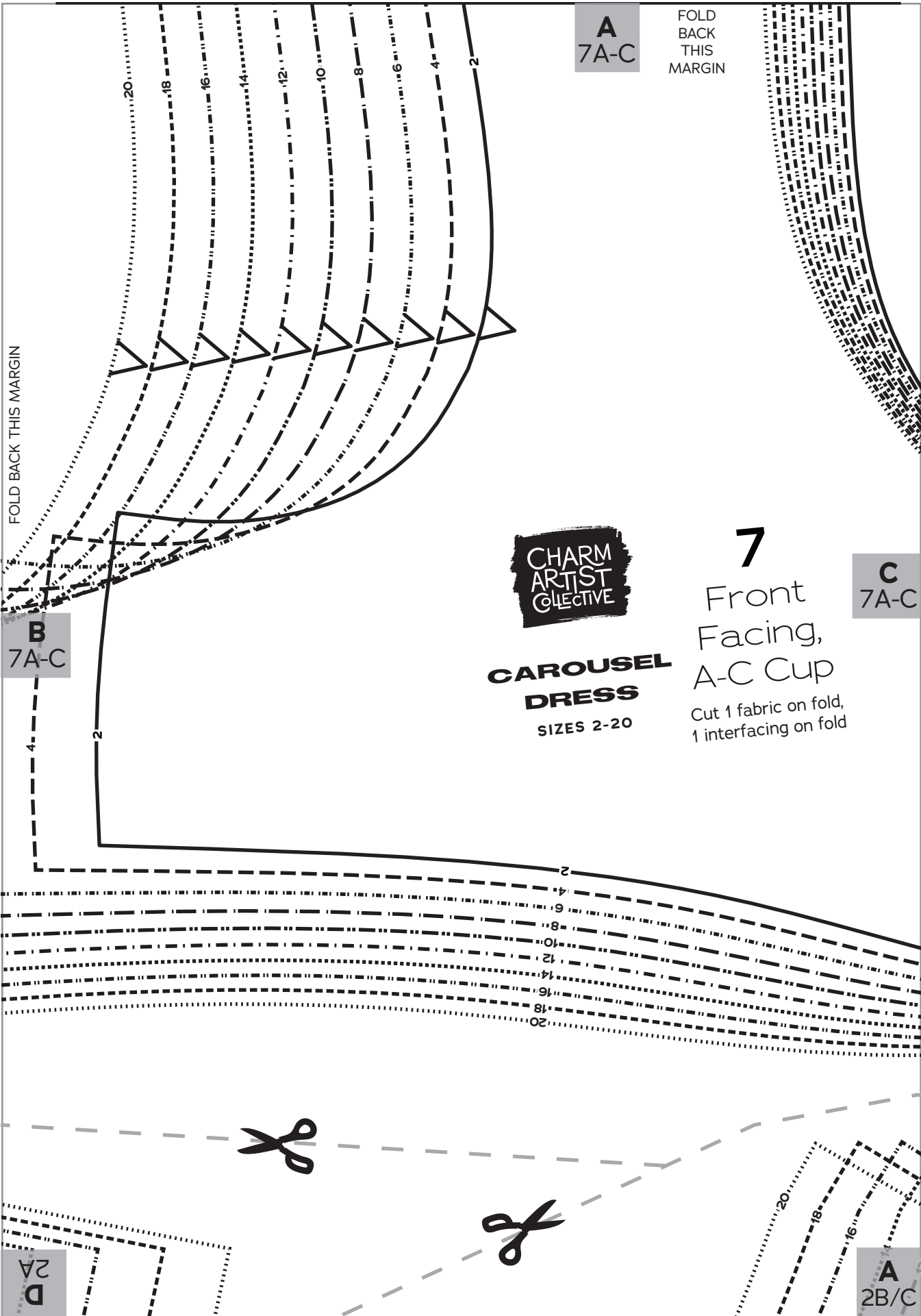

**A**  
7A-C

FOLD  
BACK  
THIS  
MARGIN

FOLD BACK THIS MARGIN



**CAROUSEL  
DRESS**  
SIZES 2-20

**7**

Front  
Facing,  
A-C Cup

Cut 1 fabric on fold,  
1 interfacing on fold

**C**  
7A-C

**B**  
7A-C

**D**  
2A

**A**  
2B/C

**C**  
7A-C

FOLD BACK THIS MARGIN

FOLD

**A**  
2B/C

**A**  
1A-C

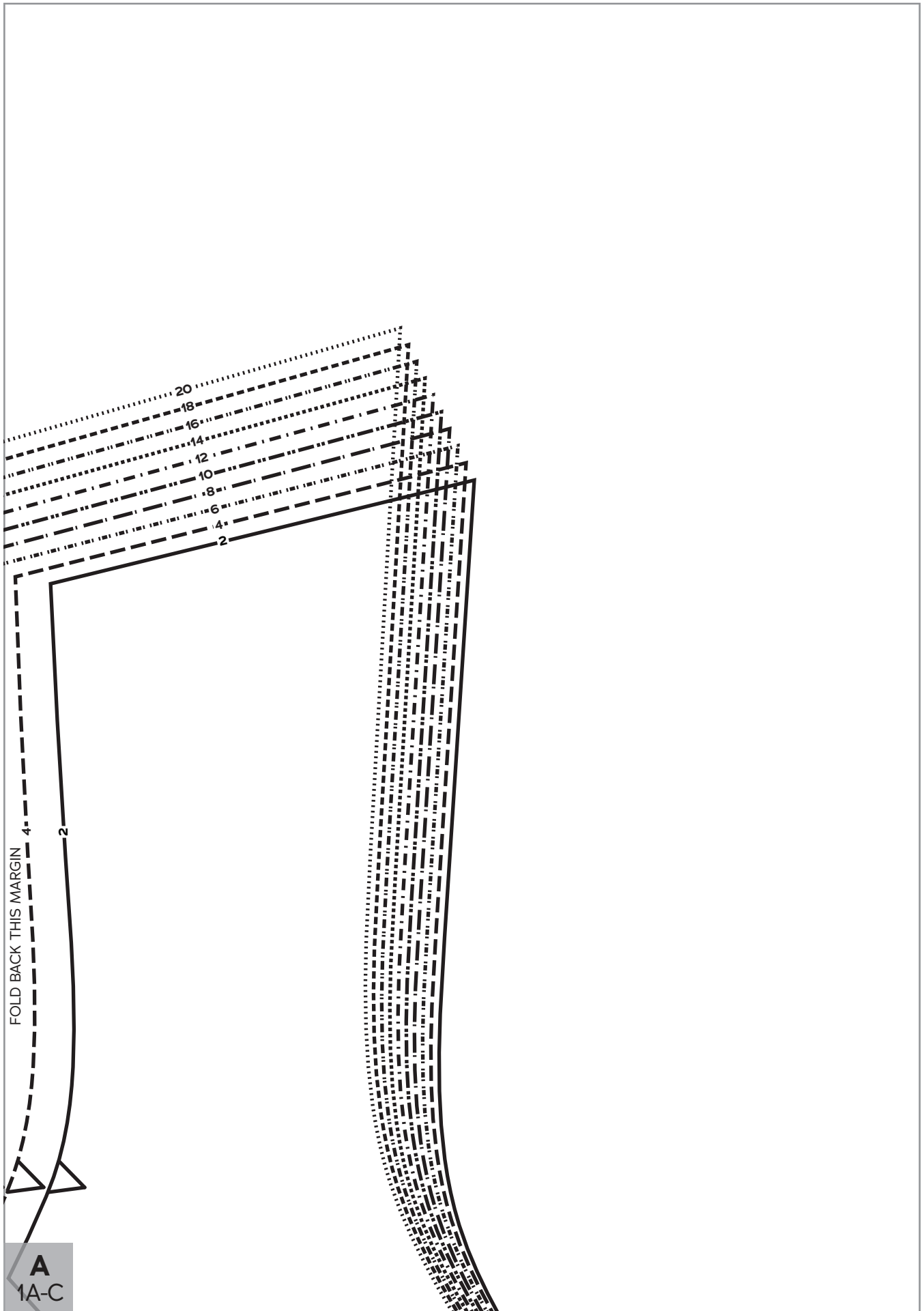

**A**  
1A-C

FOLD BACK THIS MARGIN

2A  
E

2A  
C

D  
2A

FOLD BACK THIS MARGIN

E  
2A

FOLD BACK THIS MARGIN

C  
2A

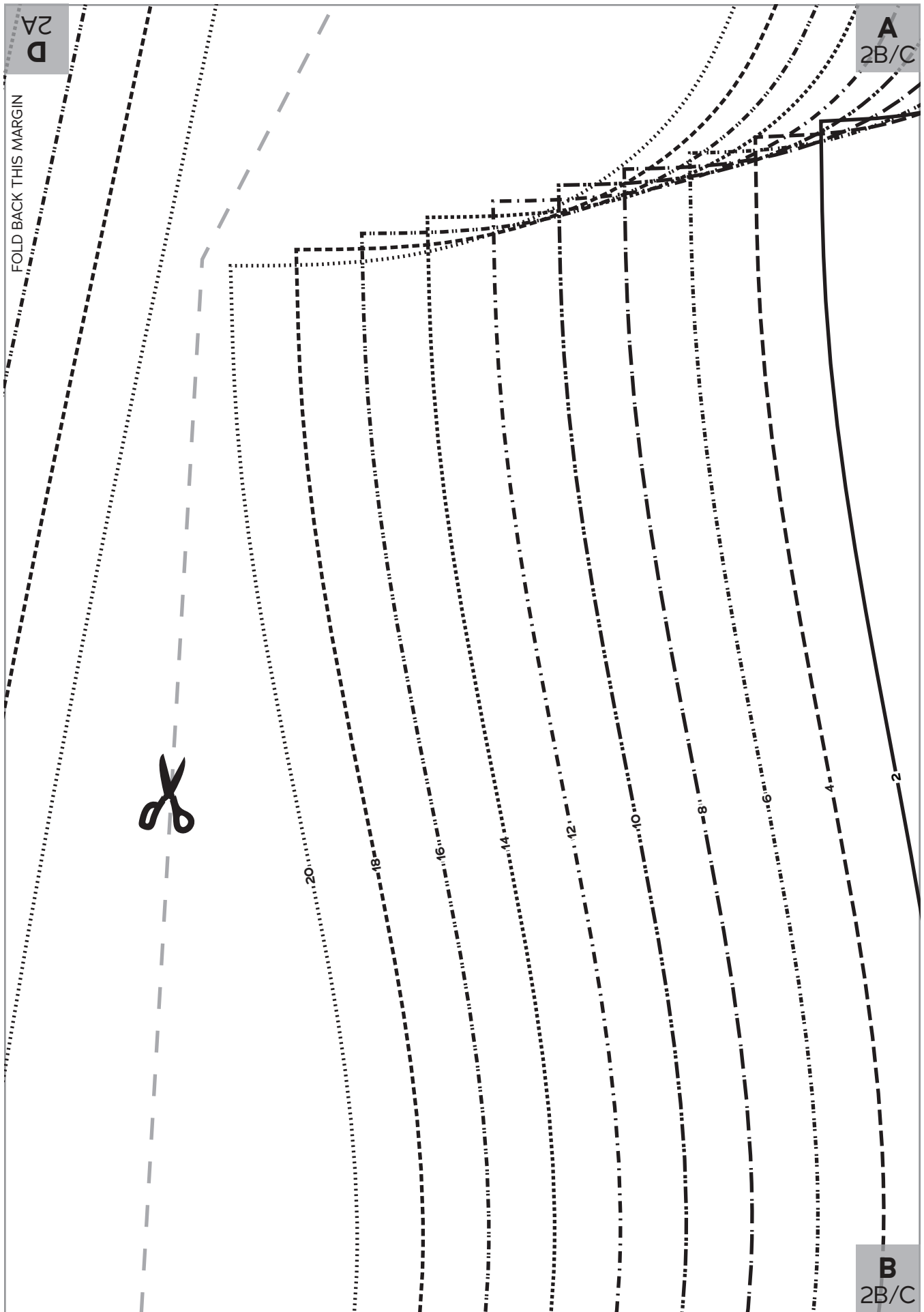



**A**  
2B/C

**A**  
1A-C

FOLD  
BACK  
THIS  
MARGIN



FOLD BACK THIS MARGIN

20 18 16 14 12 10 8 6 4 2

20 18 16 14 12 10 8 6 4 2

**B**  
2B/C

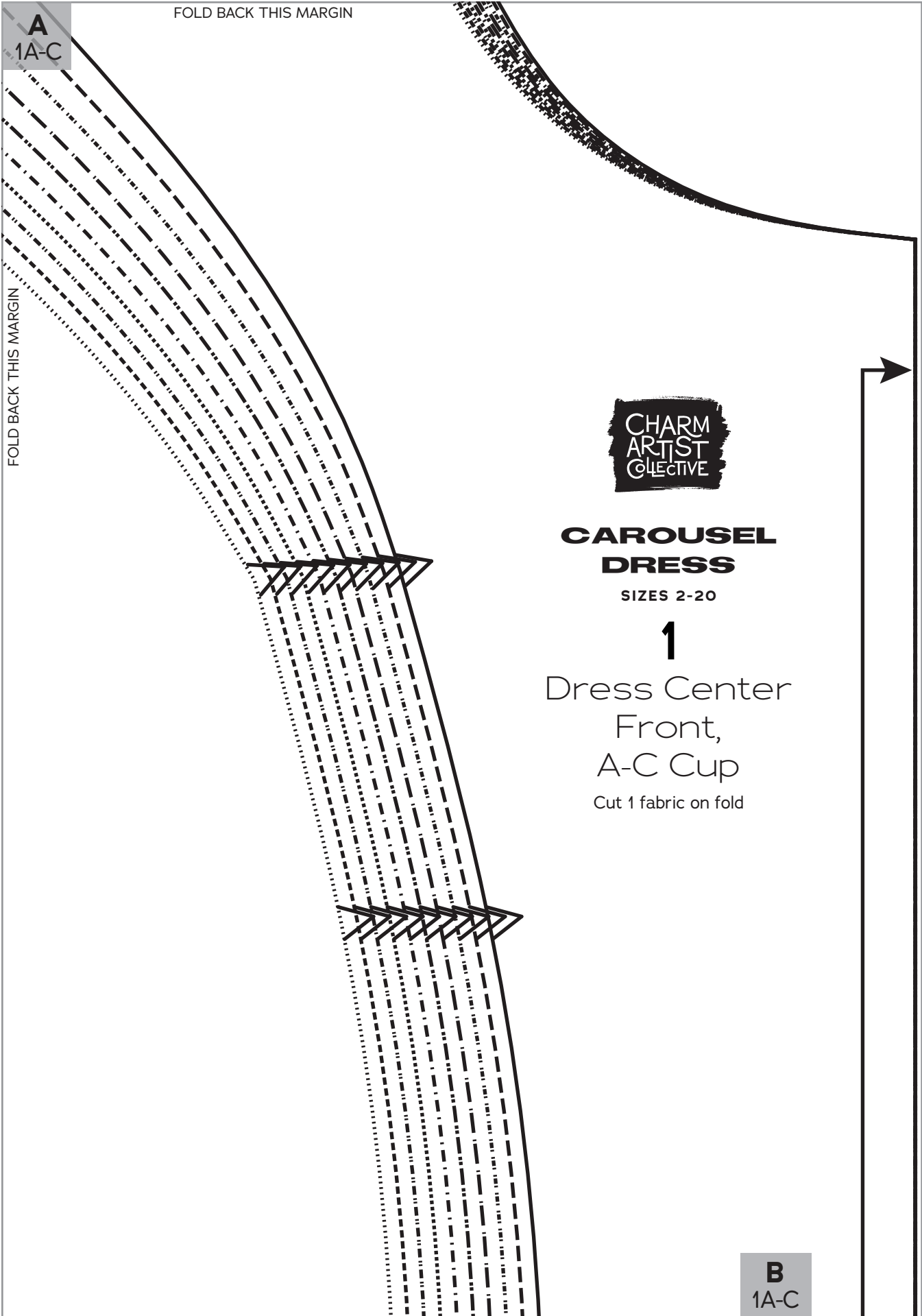

FOLD BACK THIS MARGIN

**A**  
1A-C

FOLD BACK THIS MARGIN



**CAROUSEL  
DRESS**

SIZES 2-20

**1**

Dress Center  
Front,  
A-C Cup

Cut 1 fabric on fold

**B**  
1A-C

FOLD BACK THIS MARGIN

2A  
C

FLONCE DRESS CUTTING LINE



2A  
B

C  
2A

FOLD BACK THIS MARGIN

MATCH TO  
FLOUNCE  
CIRCLE MARK

●  
2

●  
4

●  
6

●  
8

●  
10

●  
12

●  
14

●  
16

●  
18

●  
20

B  
2A

FOLD BACK THIS MARGIN

**B**  
2B/C

**C**  
2B/C

**B**  
2B/C

FOLD BACK THIS  
MARGIN

FOLD BACK THIS MARGIN



GRAINLINE



**CAROUSEL  
DRESS**

SIZES 2-20

**2**

Dress Side  
Front,  
B/C Cup

Cut 2 fabric

**C**  
2B/C

FOLD BACK THIS  
MARGIN

**B**  
1A-C



FOLD

**C**  
1A-C

2A  
B

GRAINLINE

FOLD BACK THIS MARGIN

Dress Side  
Front,  
A Cup  
Cut 2 fabric

2

SIZES 2-20

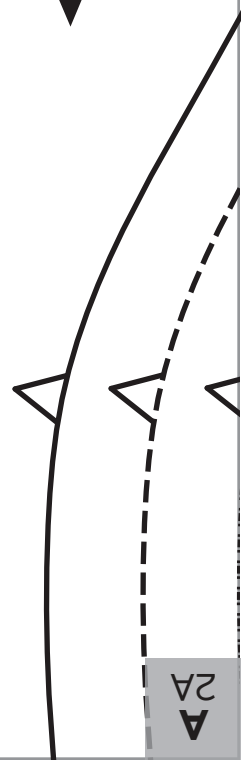
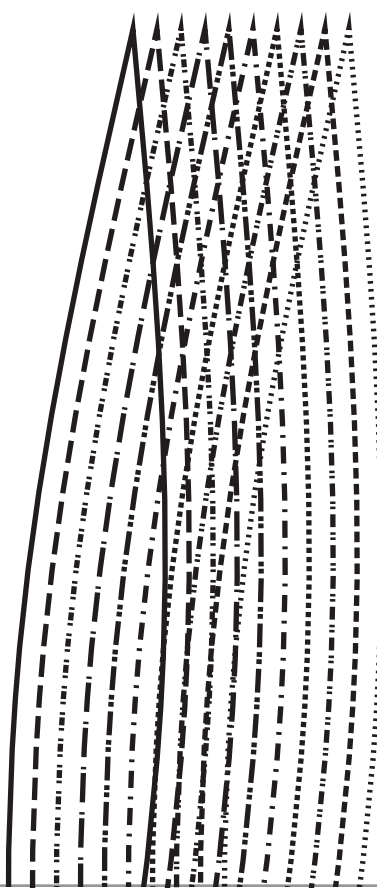
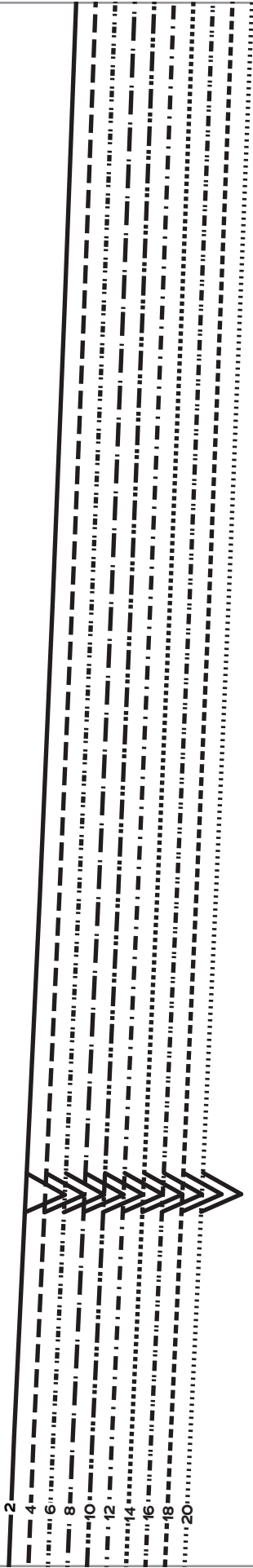

2A  
A



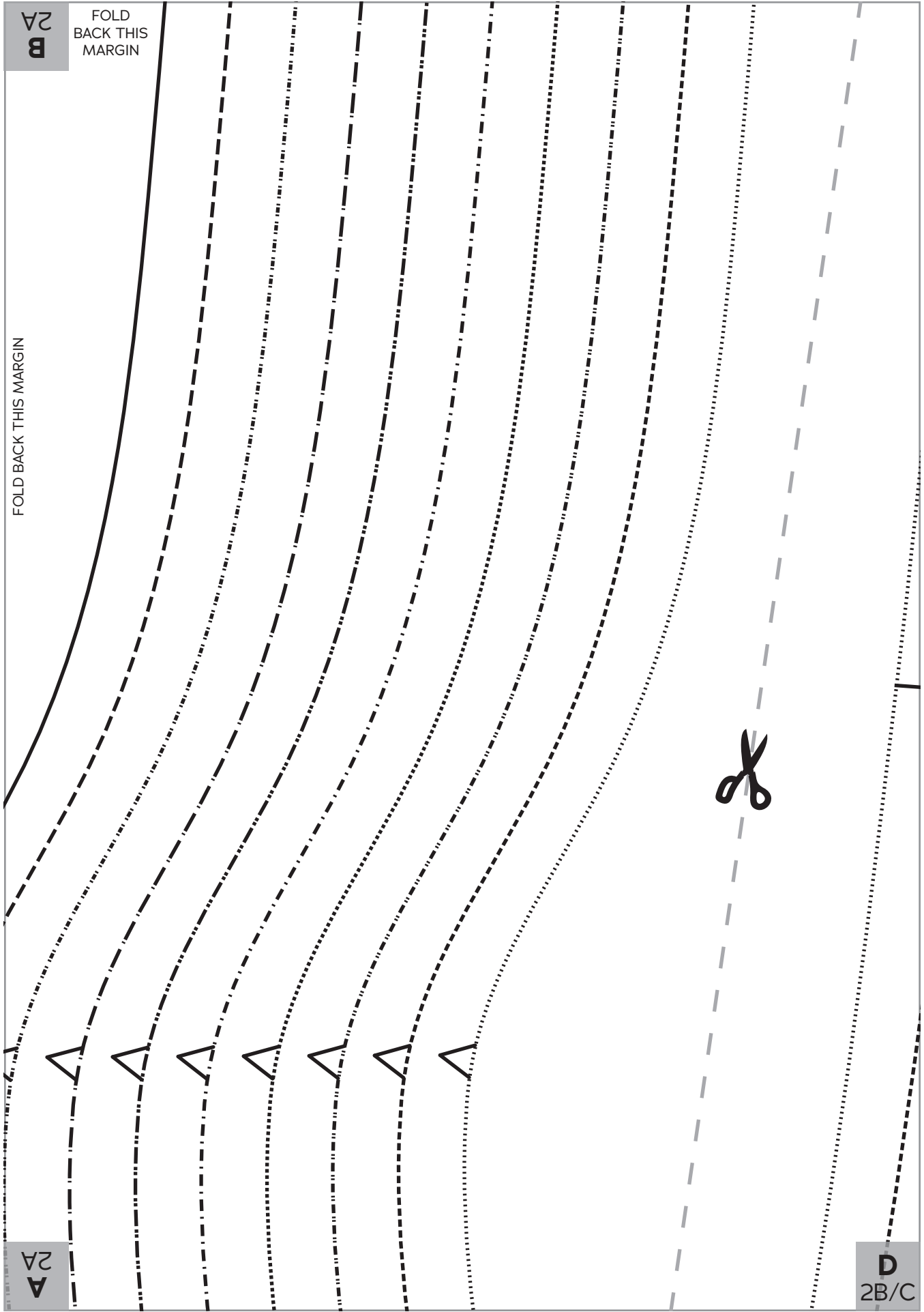

2A B

FOLD BACK THIS MARGIN

FOLD BACK THIS MARGIN

2A A

D 2B/C

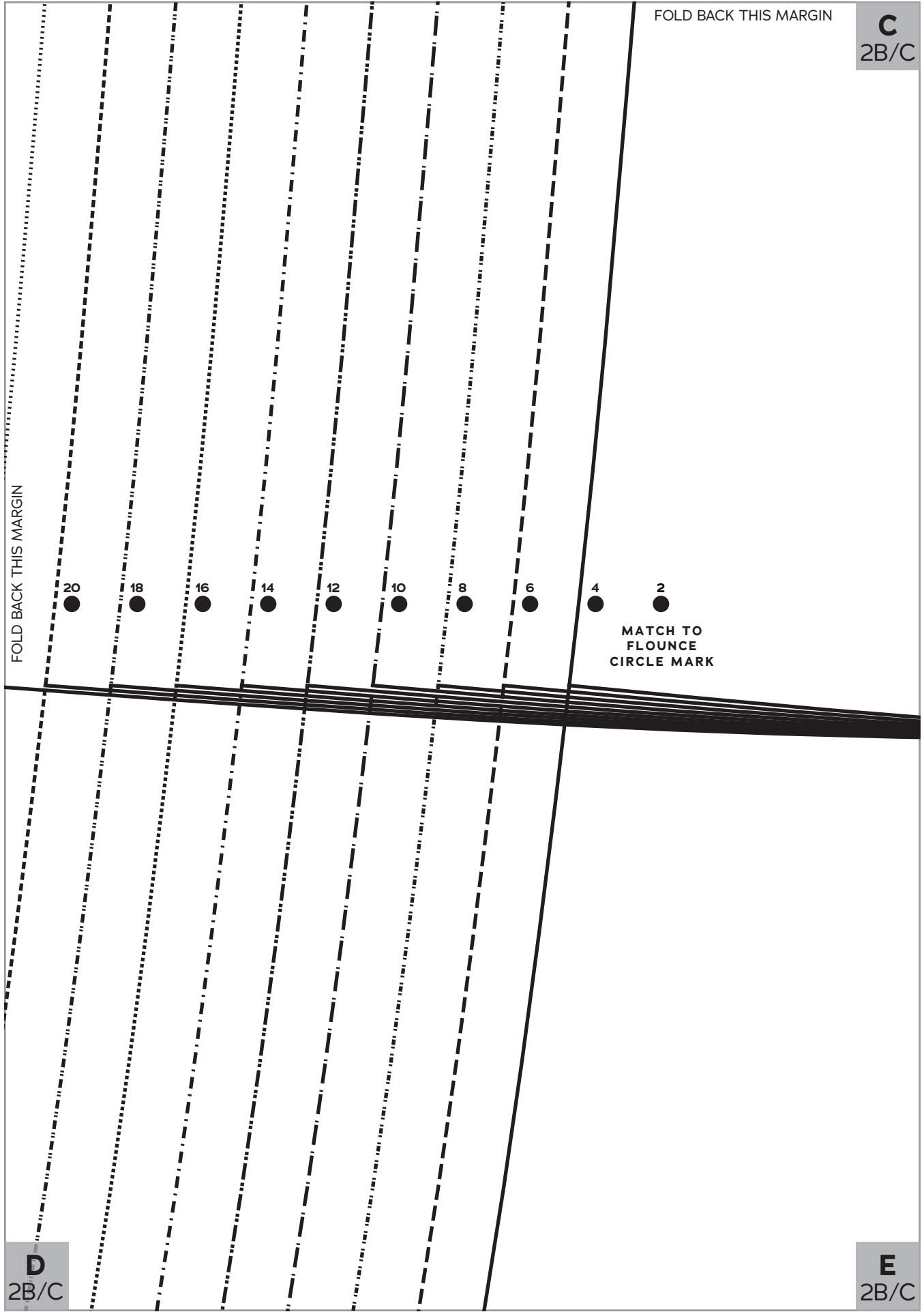

FOLD BACK THIS MARGIN

**C**  
2B/C

FOLD BACK THIS MARGIN

20 ●

18 ●

16 ●

14 ●

12 ●

10 ●

8 ●

6 ●

4 ●

2 ●

MATCH TO  
FLOUNCE  
CIRCLE MARK

**D**  
2B/C

**E**  
2B/C

**C**  
2B/C

FOLD BACK THIS MARGIN

FOLD BACK THIS MARGIN



**E**  
2B/C

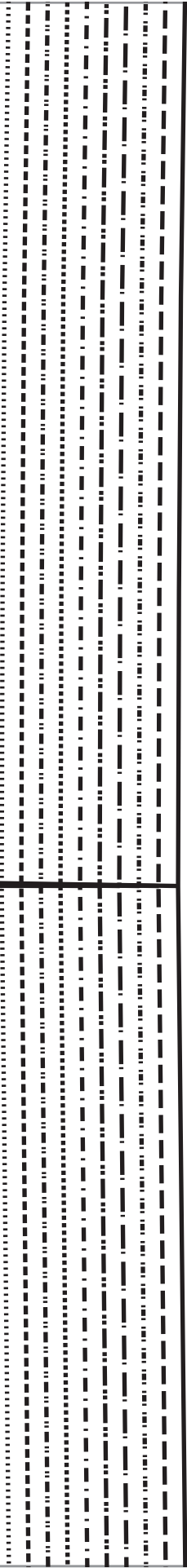

FOLD BACK THIS MARGIN

**C**  
1A-C

20  
18  
16  
14  
12  
10  
8  
6  
4  
2

FLOUNCE DRESS CUTTING LINE

**D**  
1A-C

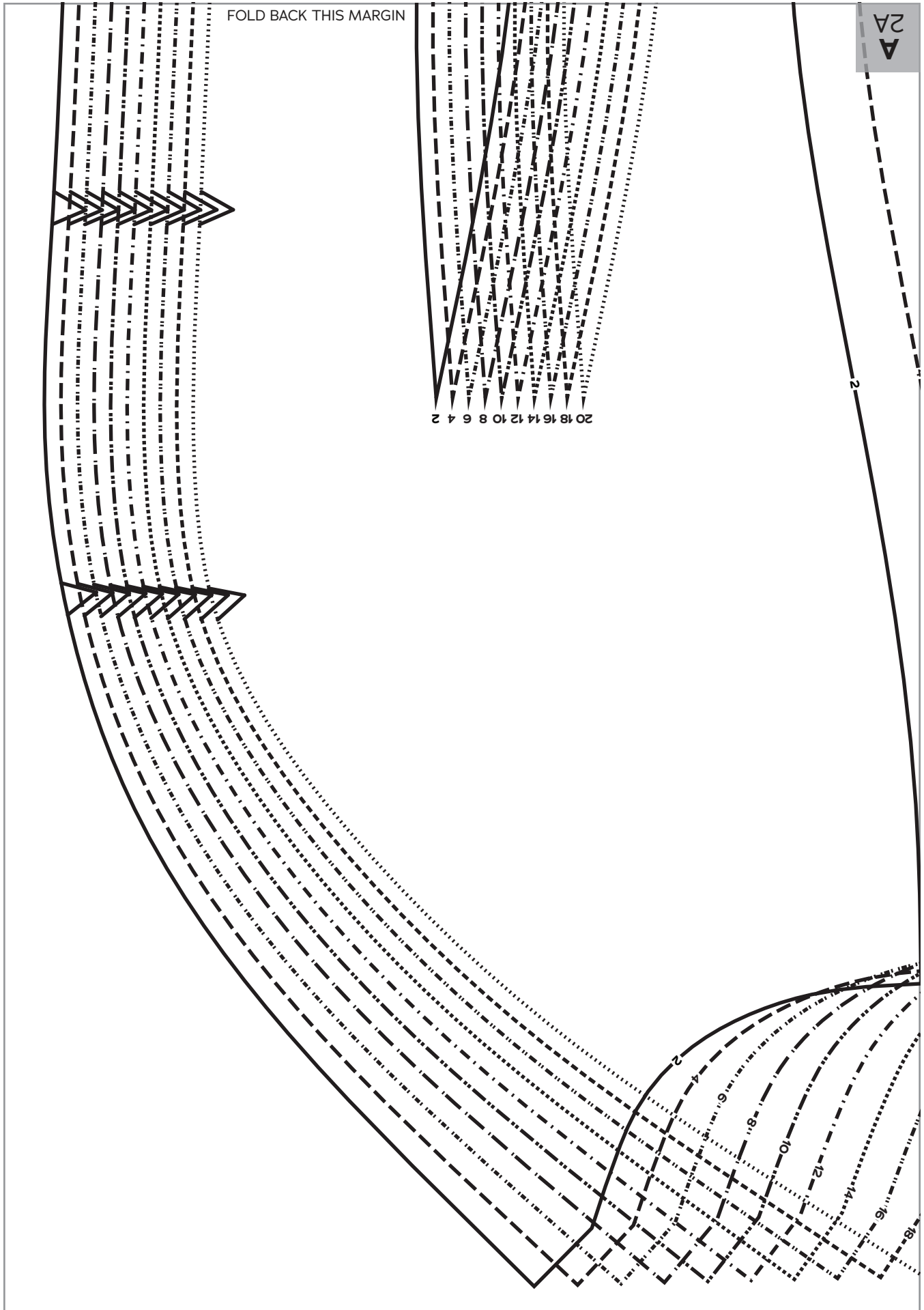

FOLD BACK THIS MARGIN

2A

20 18 16 14 12 10 8 6 4 2

2  
4  
6  
8  
10  
12  
14  
16  
18

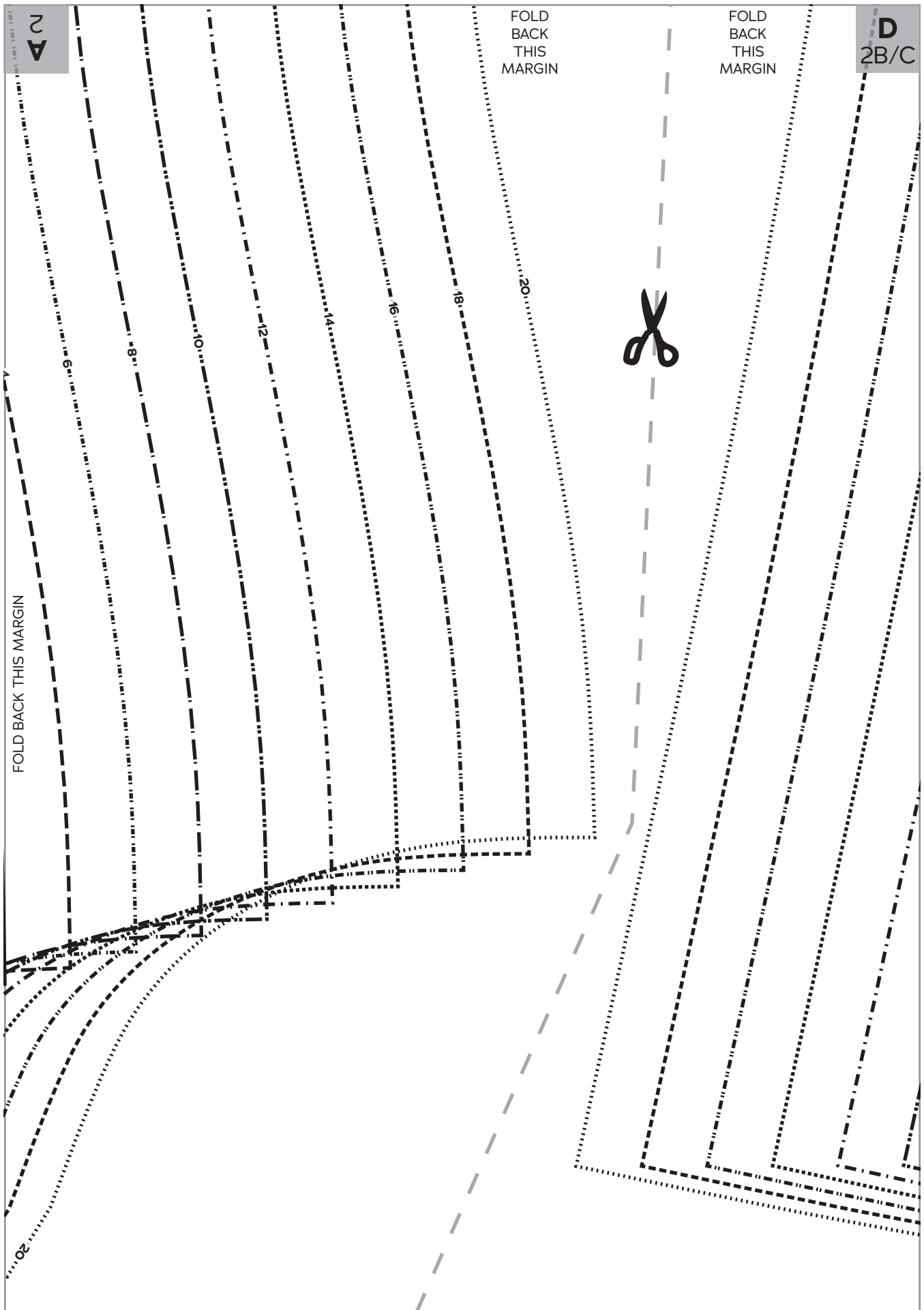

**D**  
2B/C

FOLD BACK THIS MARGIN

**E**  
2B/C

FOLD BACK THIS MARGIN

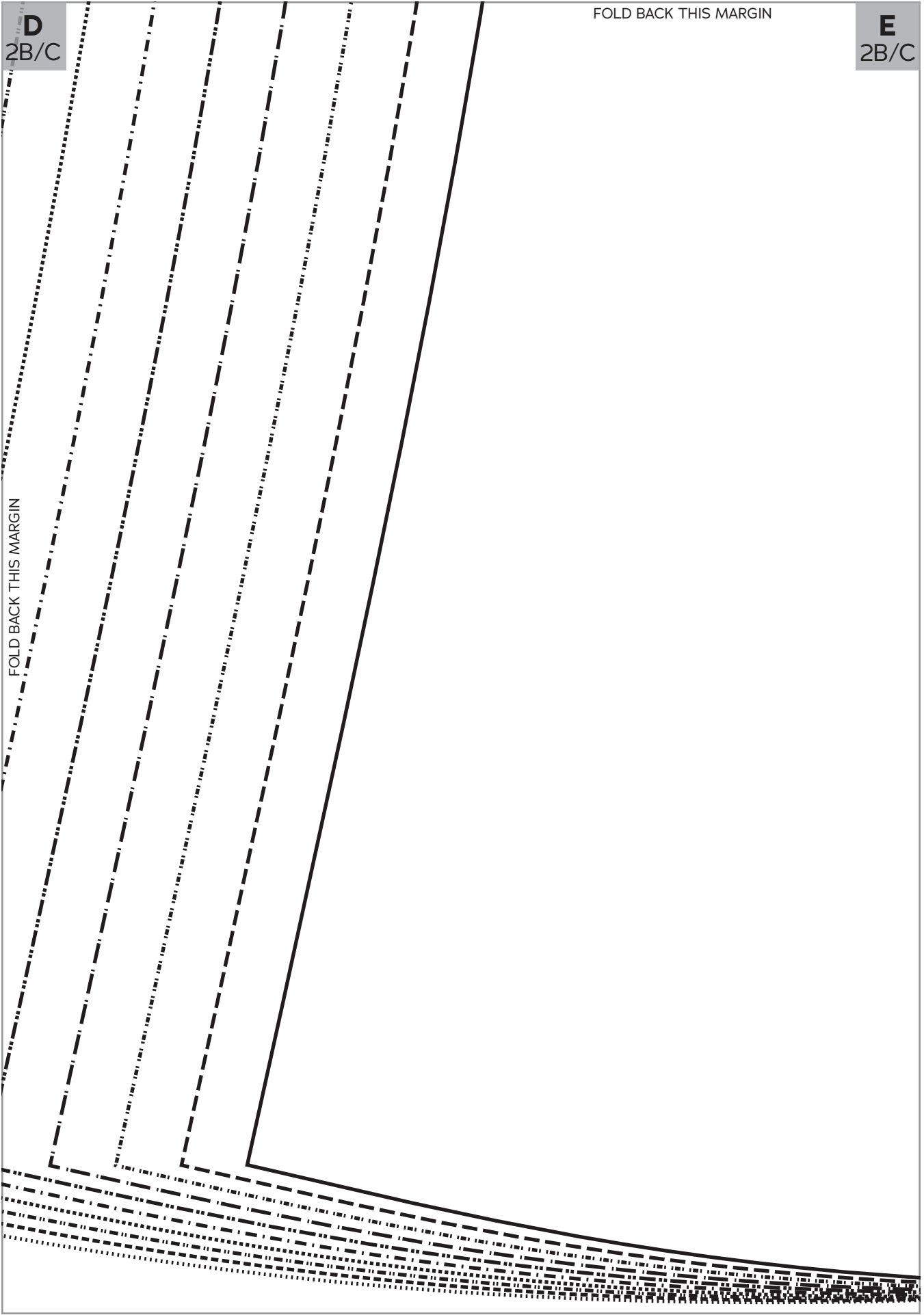

**E**  
2B/C

FOLD BACK THIS MARGIN

FOLD BACK THIS MARGIN



**F**  
1A-C



FOLD BACK THIS MARGIN

**D**  
1A-C

FOLD BACK THIS MARGIN

**F**  
1A-C

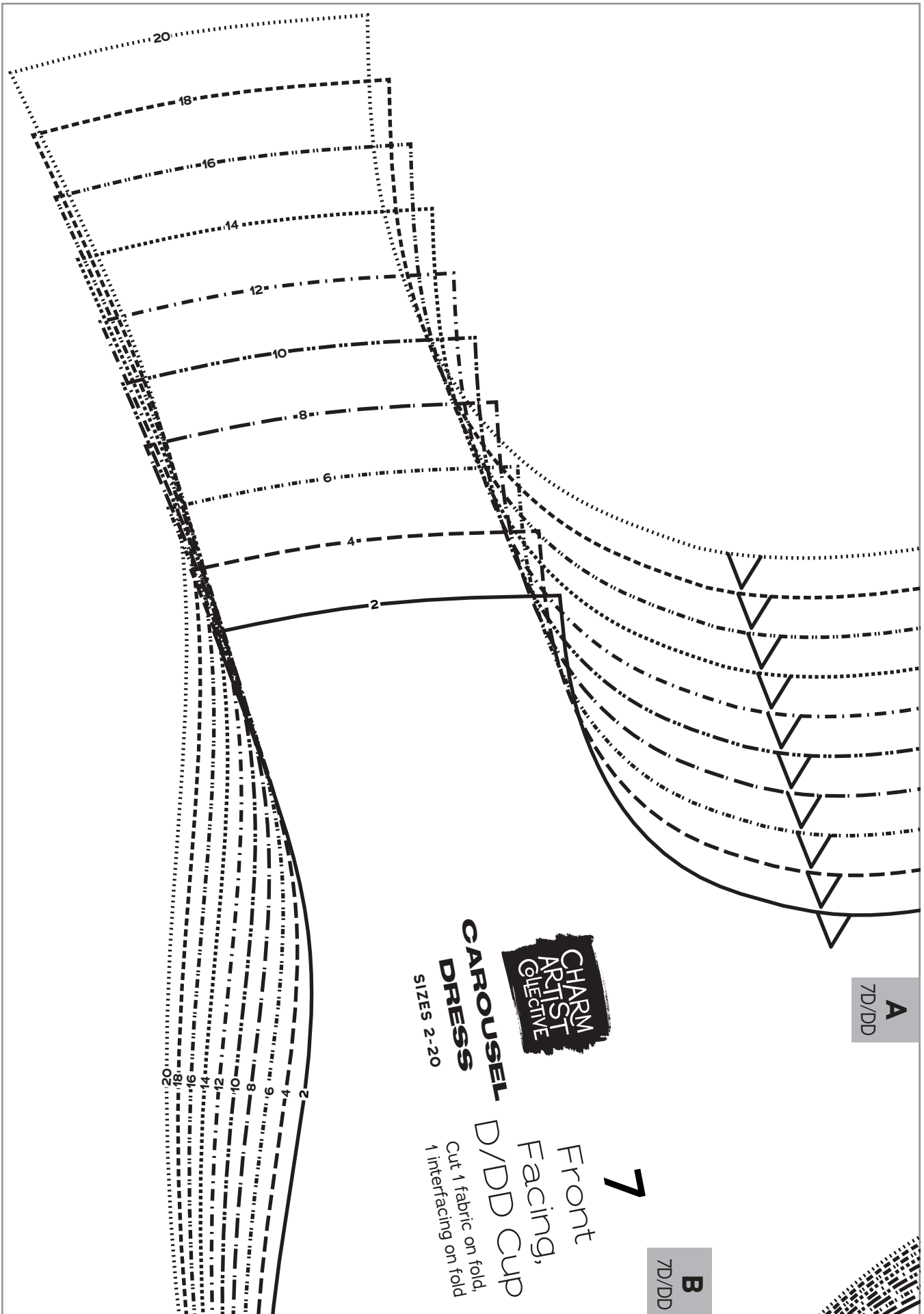

**A**  
7D/DD

**B**  
7D/DD

**CHARM  
ARTIST  
COLLECTIVE**  
**CAROUSEL  
DRESS**  
SIZES 2-20

**7**  
Front  
Facing,  
D/DD Cup  
Cut 1 fabric on fold,  
1 interfacing on fold

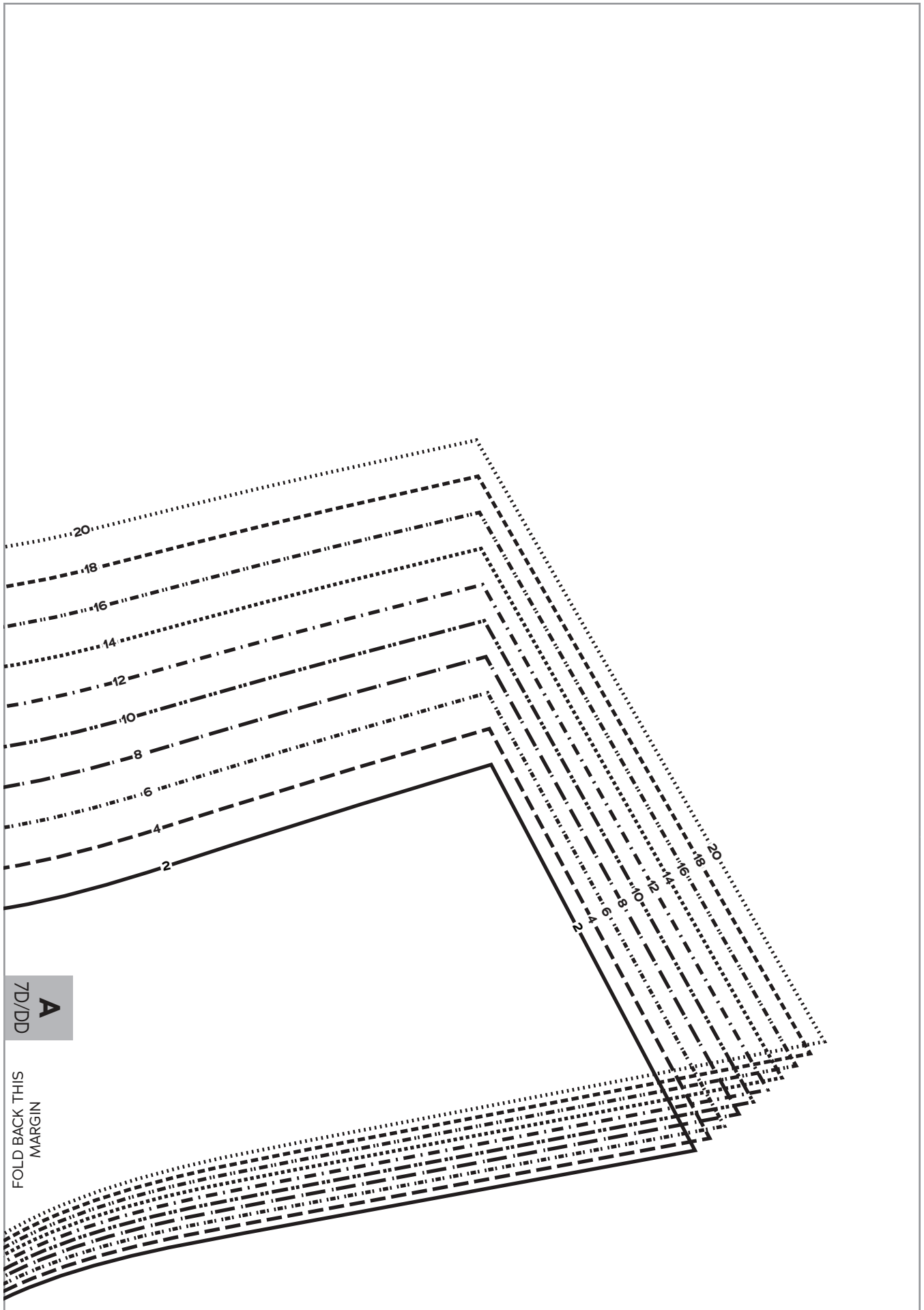

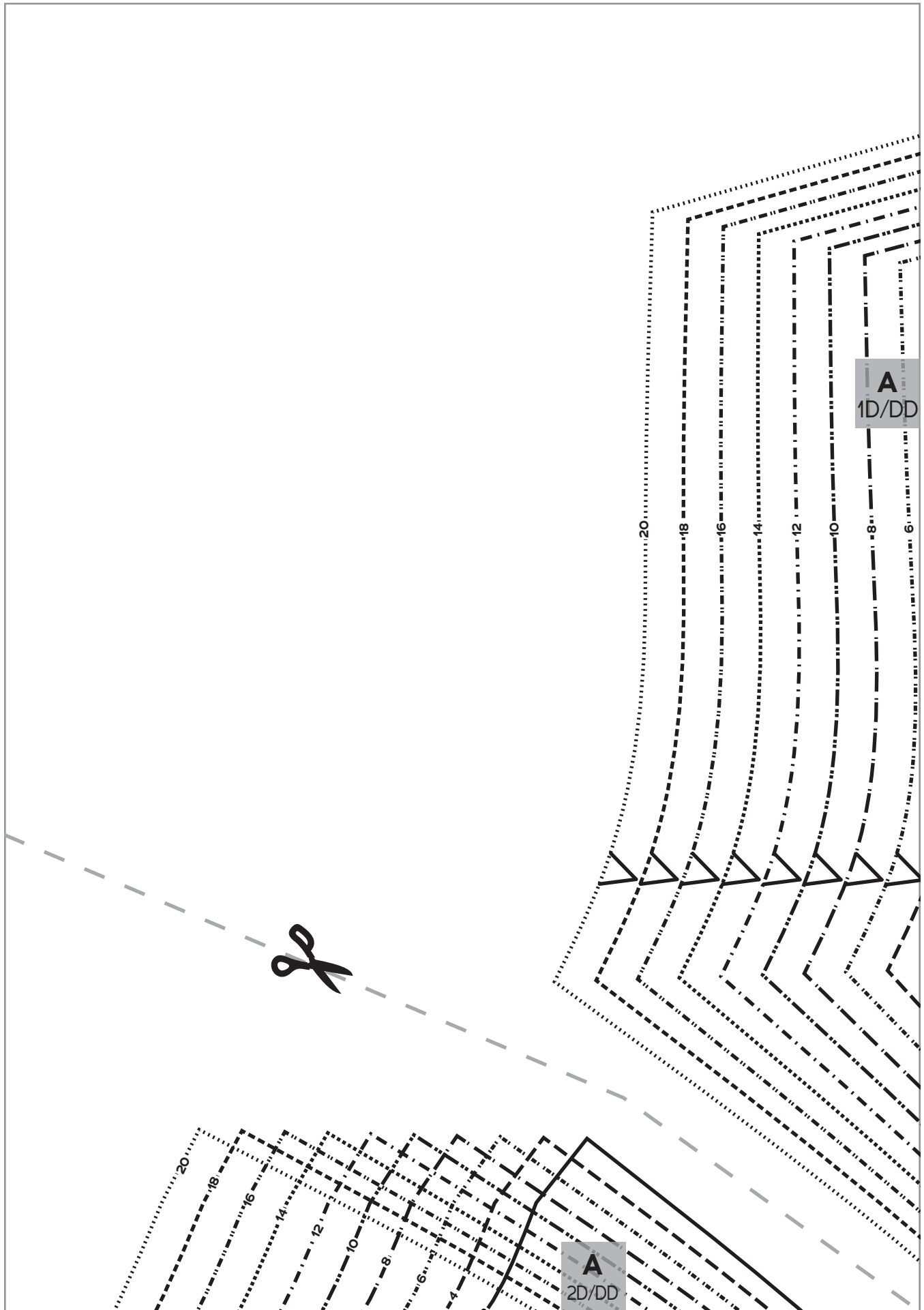

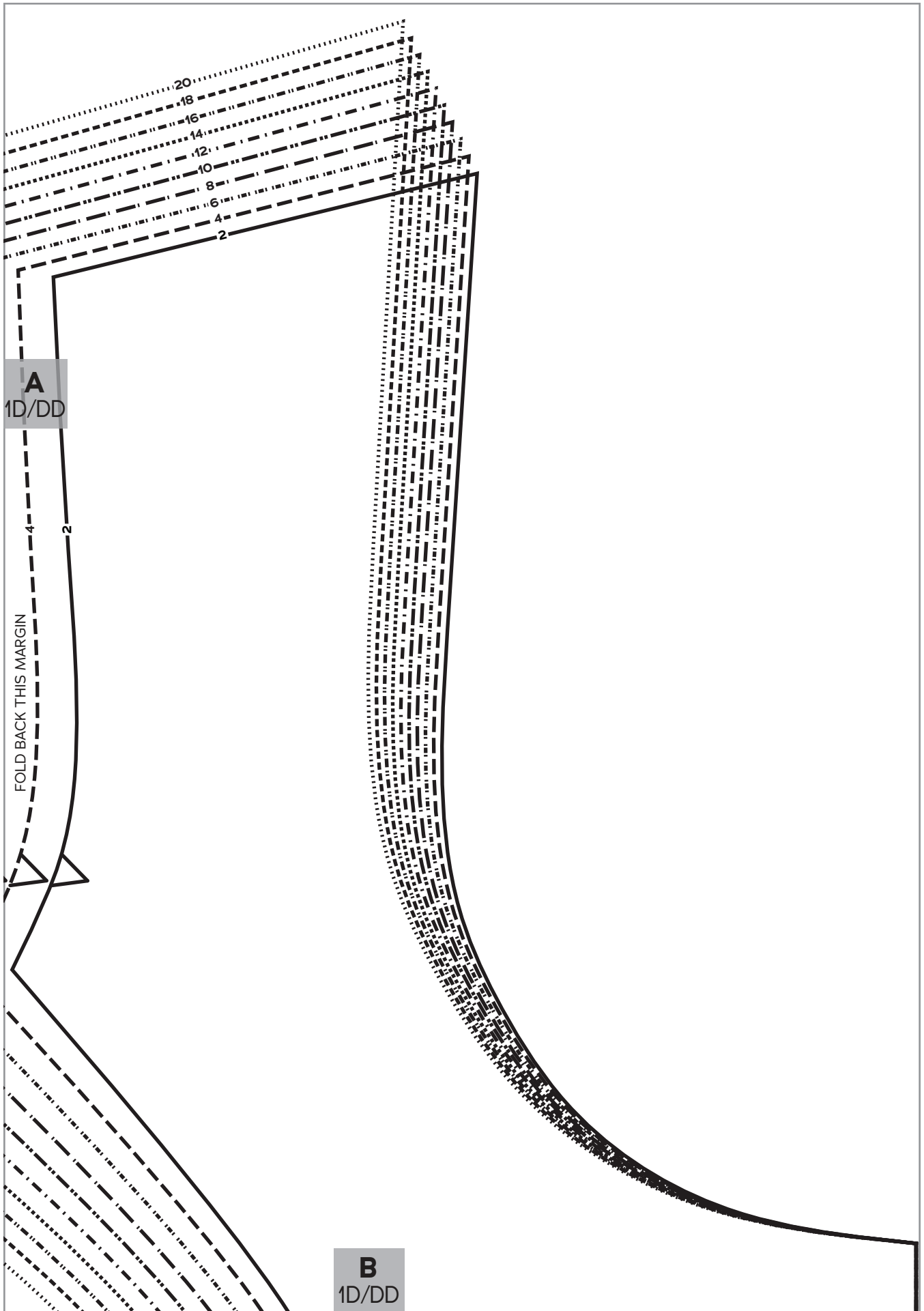

FOLD BACK THIS MARGIN

**B**  
7D/DD

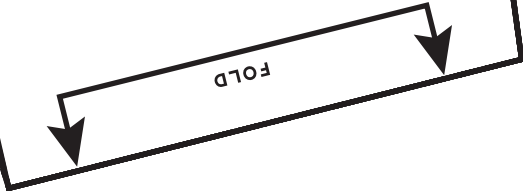

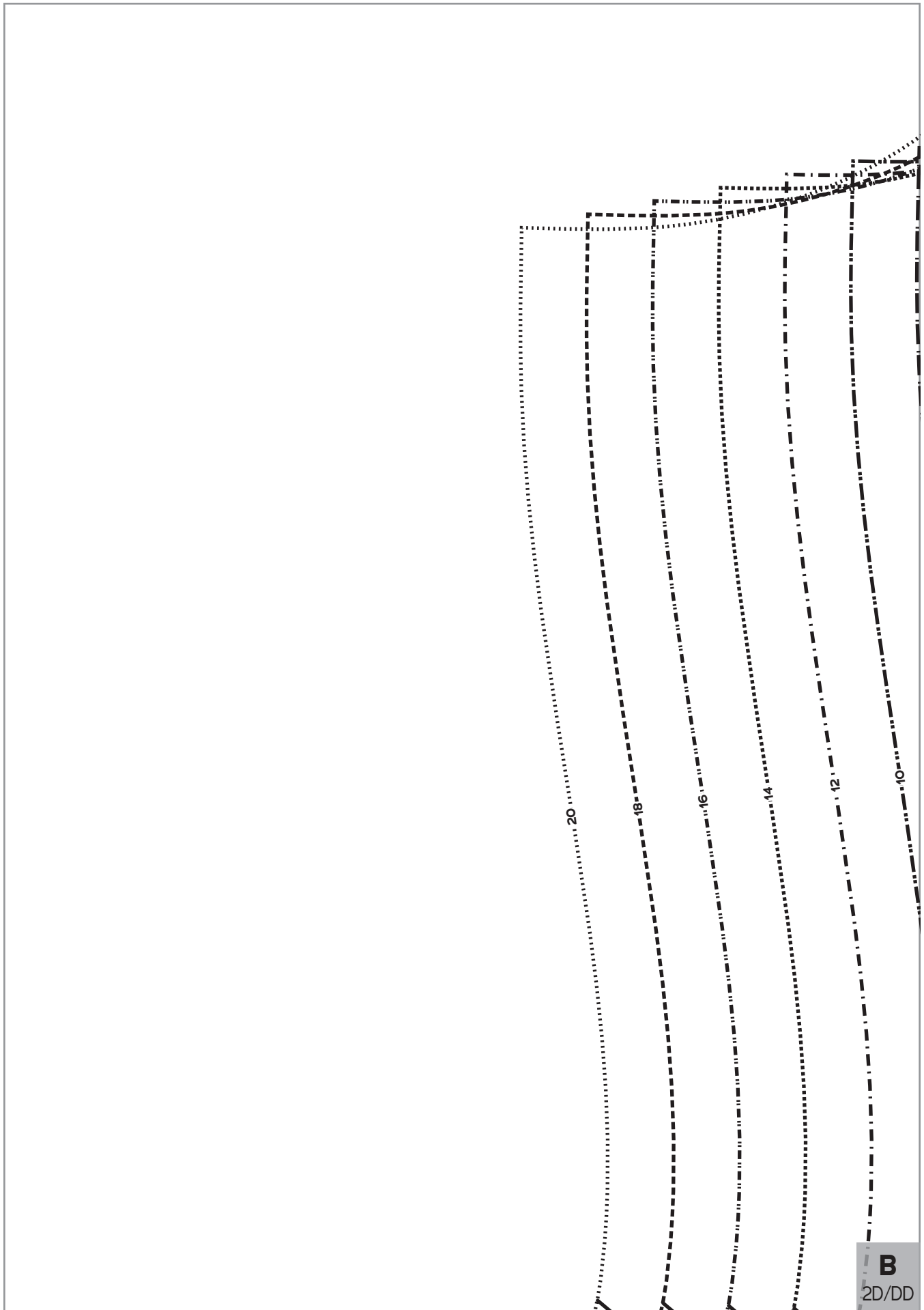

**B**  
2D/DD

FOLD  
BACK  
THIS  
MARGIN

**A**  
2D/DD

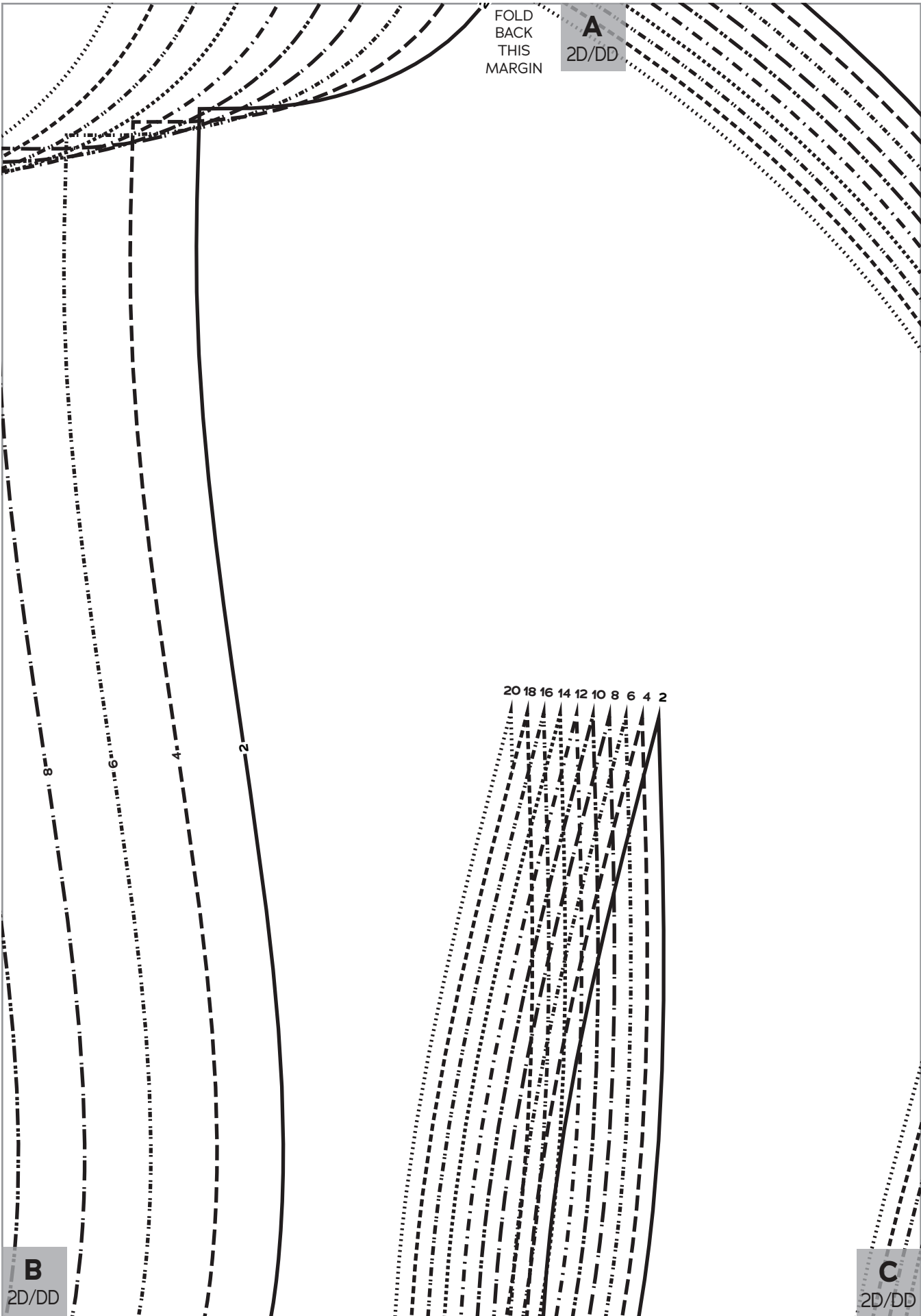

**B**  
2D/DD

**C**  
2D/DD



**B**  
1D/DD



# CAROUSEL DRESS

SIZES 2-20

**1**

Dress Center  
Front,  
D/DD Cup

Cut 1 fabric on fold

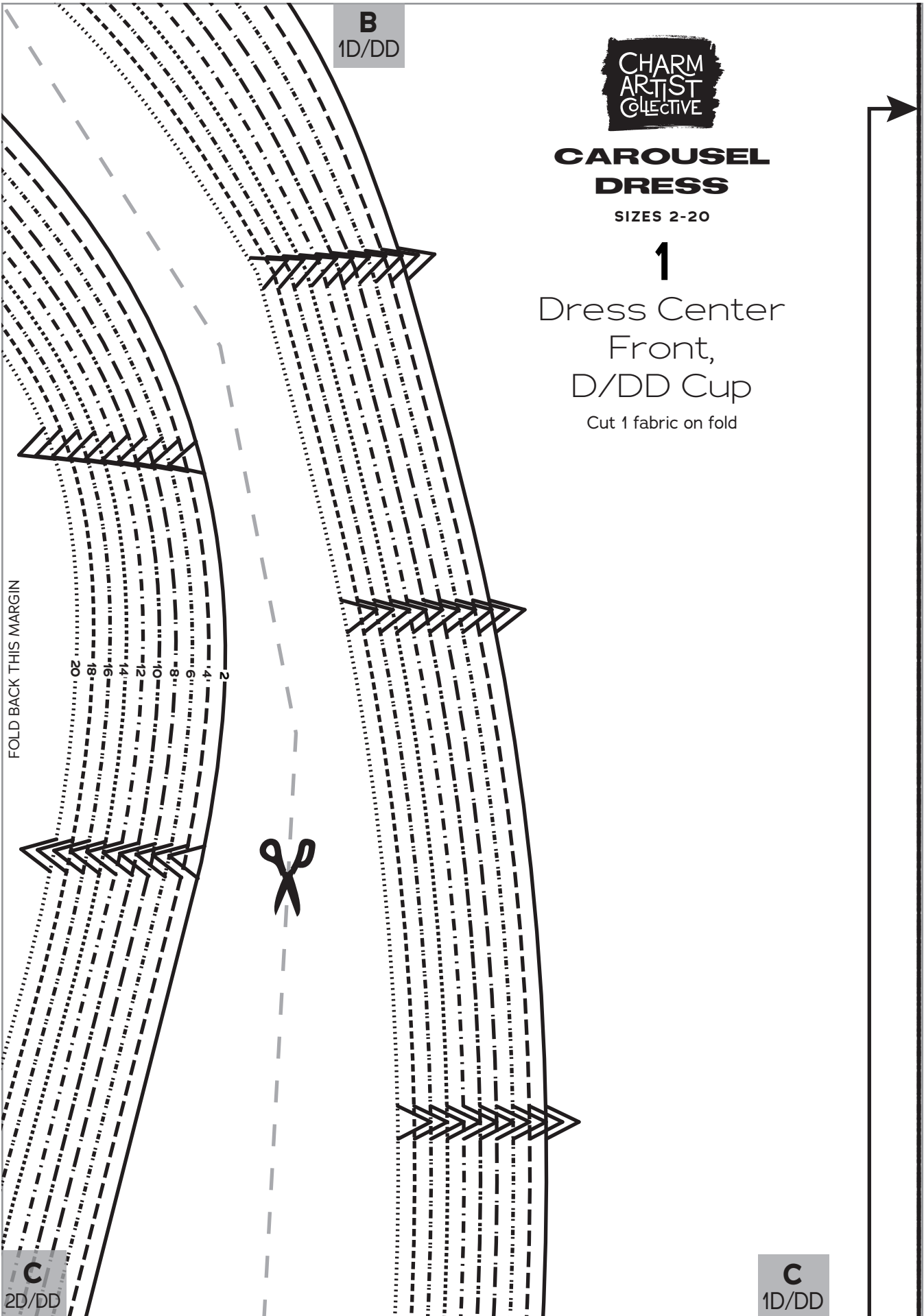

**C**  
2D/DD

**C**  
1D/DD

FOLD BACK THIS MARGIN

**B**  
2D/DD

**D**  
2D/DD

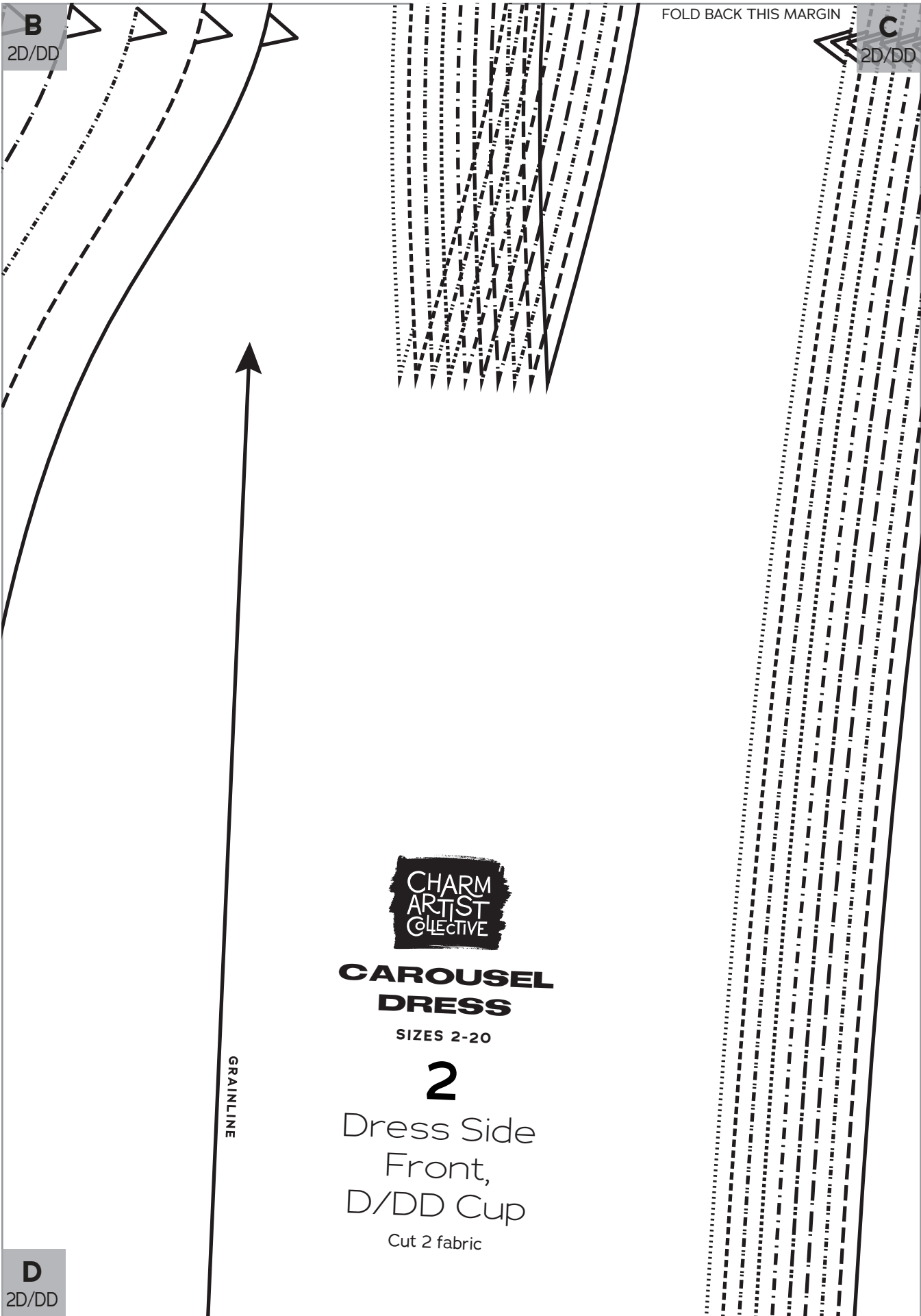

**B**  
2D/DD

FOLD BACK THIS MARGIN

**C**  
2D/DD



**CAROUSEL  
DRESS**

SIZES 2-20

**2**

Dress Side  
Front,  
D/DD Cup

Cut 2 fabric

GRAINLINE

**D**  
2D/DD

**C**  
2D/DD

FOLD BACK THIS MARGIN

**C**  
1D/DD

FOLD

FOLD BACK THIS MARGIN



**D**  
1D/DD

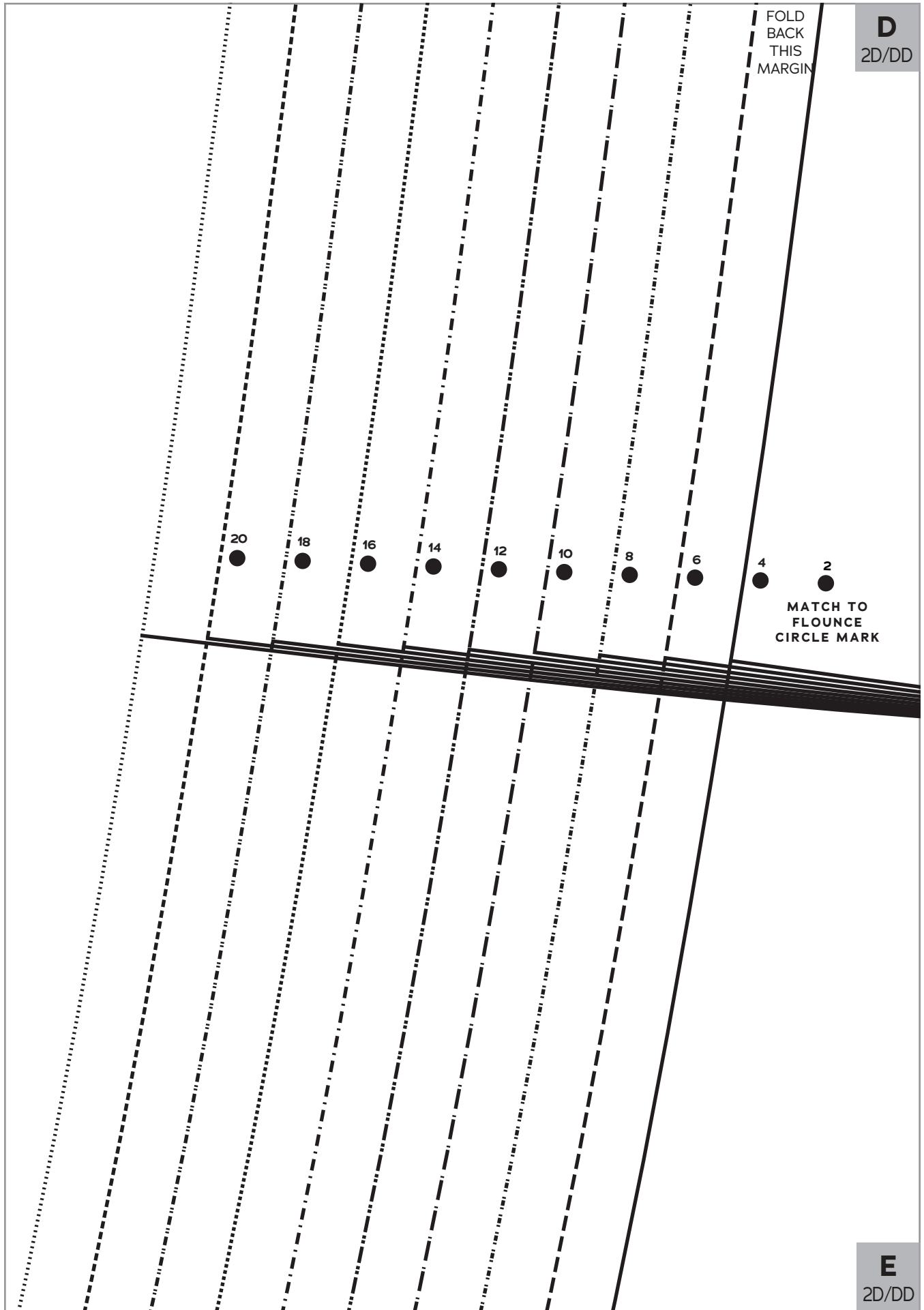

FOLD  
BACK  
THIS  
MARGIN

**D**  
2D/DD

20

18

16

14

12

10

8

6

4

2

MATCH TO  
FLOUNCE  
CIRCLE MARK

**E**  
2D/DD

**D**  
2D/DD

FOLD BACK THIS MARGIN



FLOUNCE DRESS CUTTING LINE

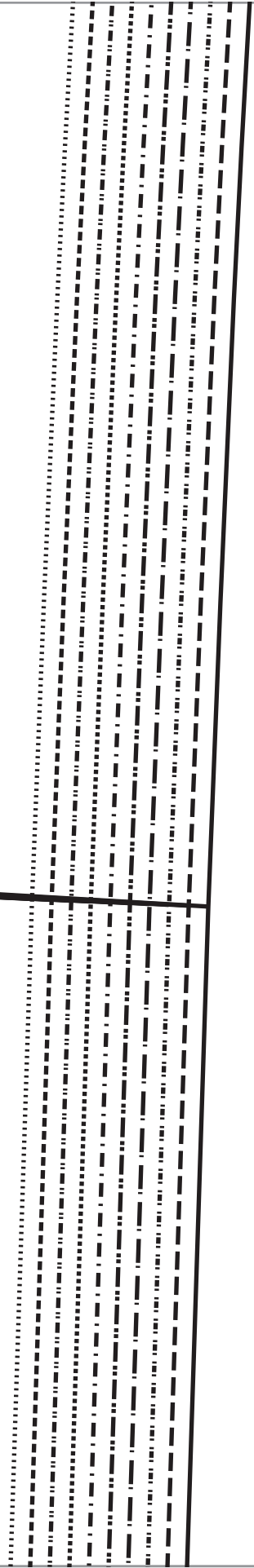

**E**  
2D/DD

**D**  
1D/DD

FOLD BACK THIS MARGIN

20  
18  
16  
14  
12  
10  
8  
6  
4  
2

FLOUNCE DRESS CUTTING LINE

**E**  
1D/DD

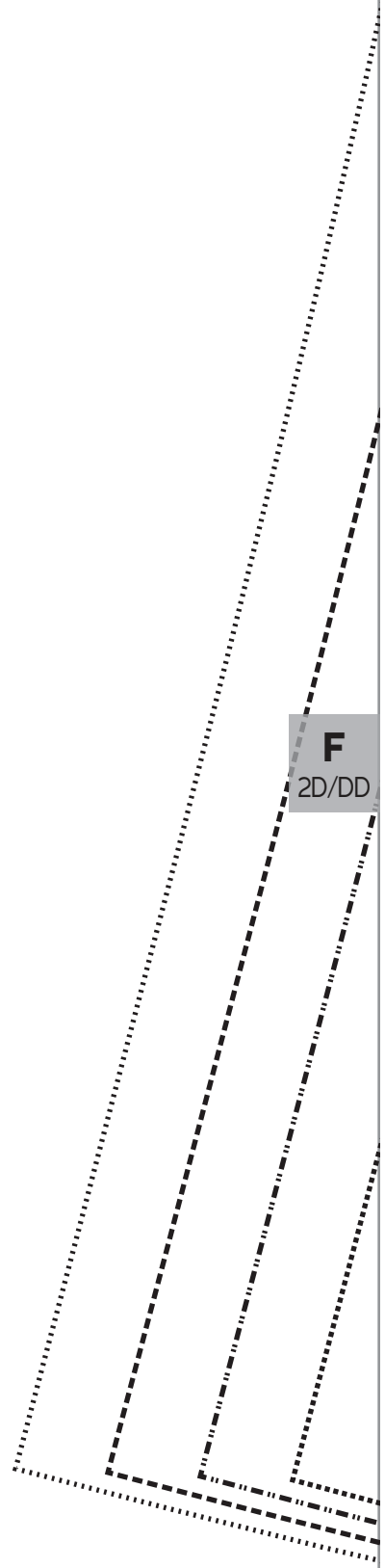

**F**  
2D/DD



**E**  
2D/DD

**F**  
2D/DD

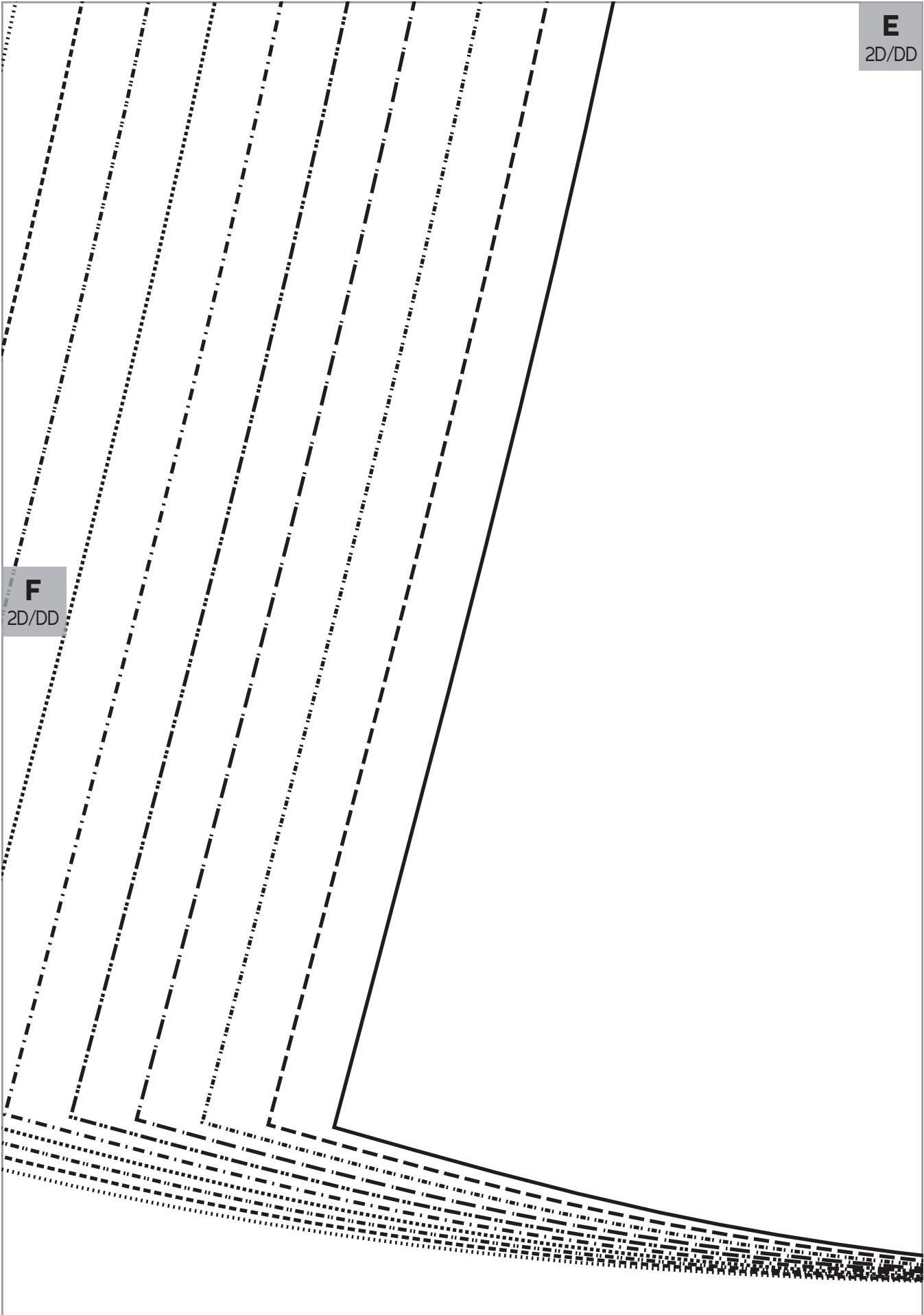

**E**  
2D/DD

FOLD BACK THIS MARGIN



**F**  
1D/DD

**E**  
1D/DD

FOLD BACK THIS MARGIN

**F**  
1D/DD

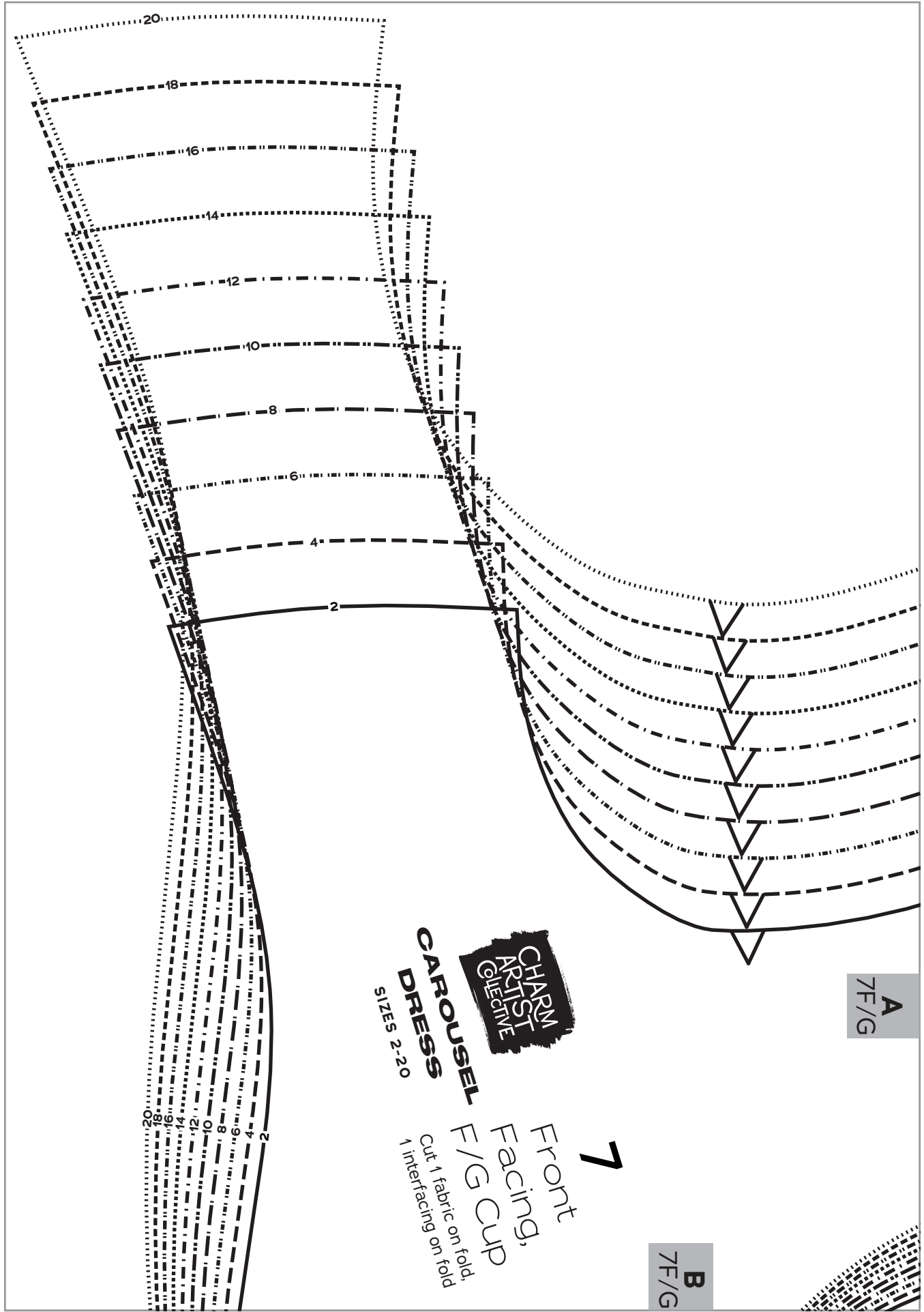

**A**  
7F/G

**B**  
7F/G

**CHARM ARTIST PATTERN COLECTIVE**  
**CAROUSEL DRESS**  
SIZES 2-20

**7**  
Front Facing, F/G Cup  
Cut 1 fabric on fold, 1 interfacing on fold

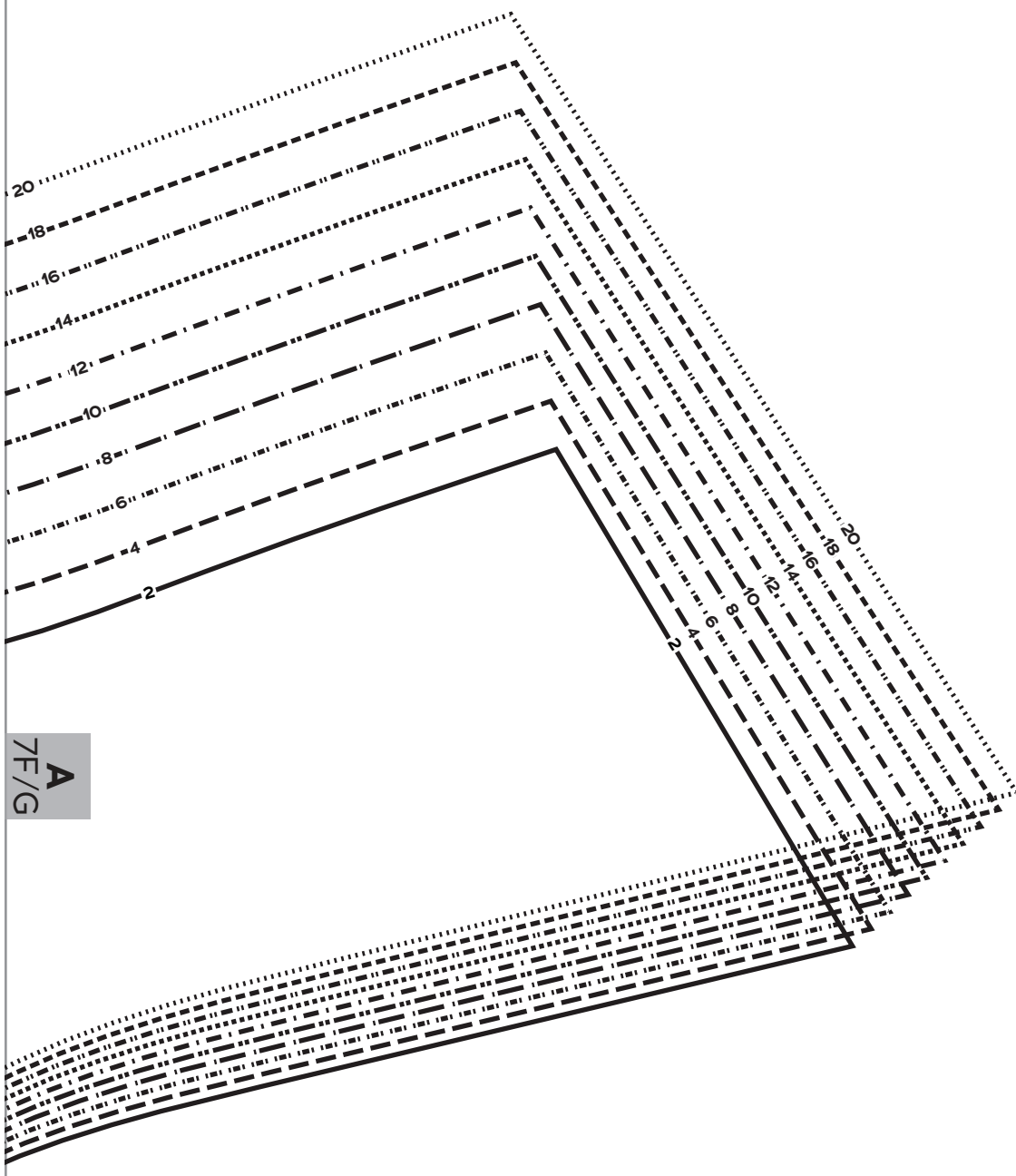

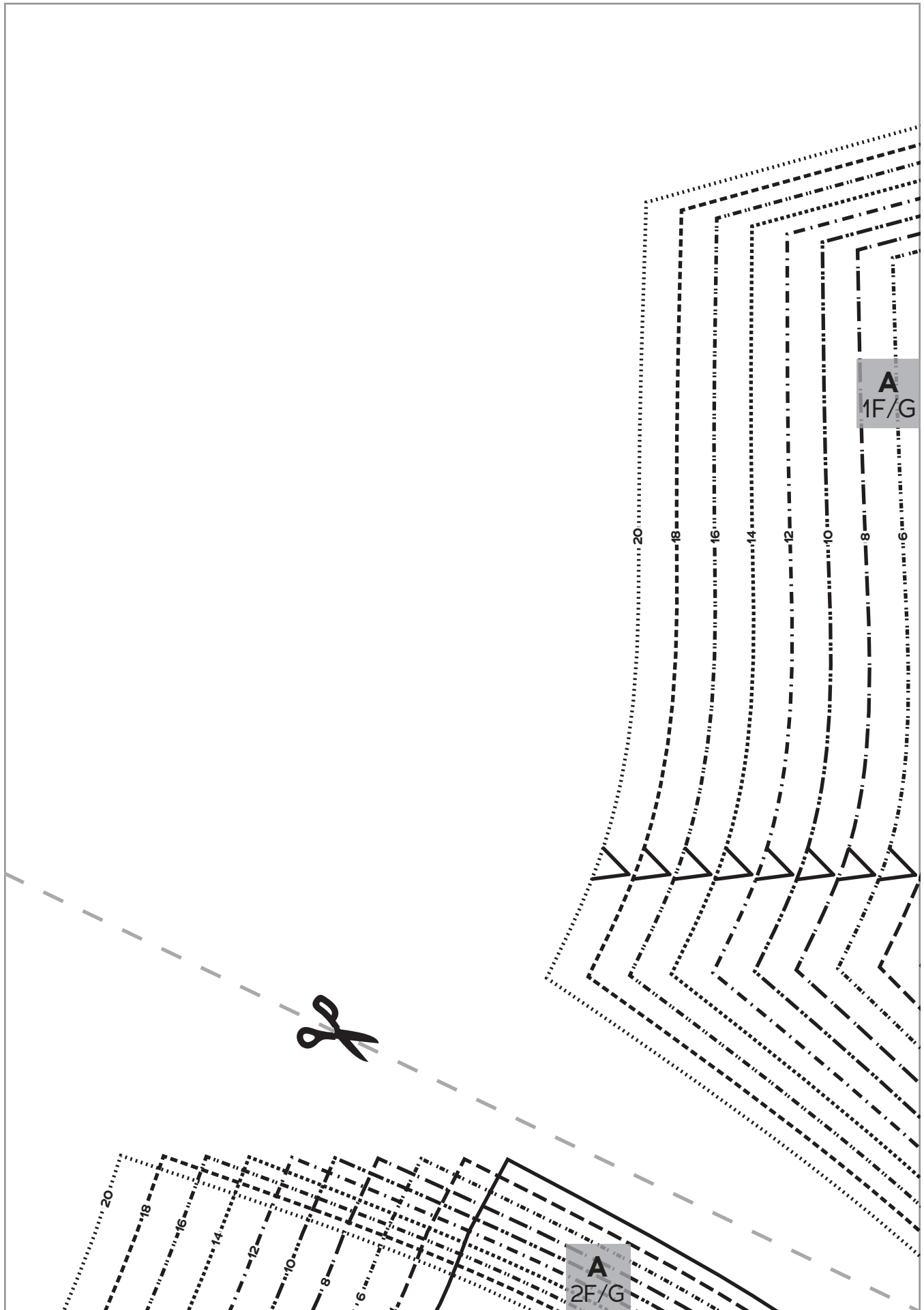

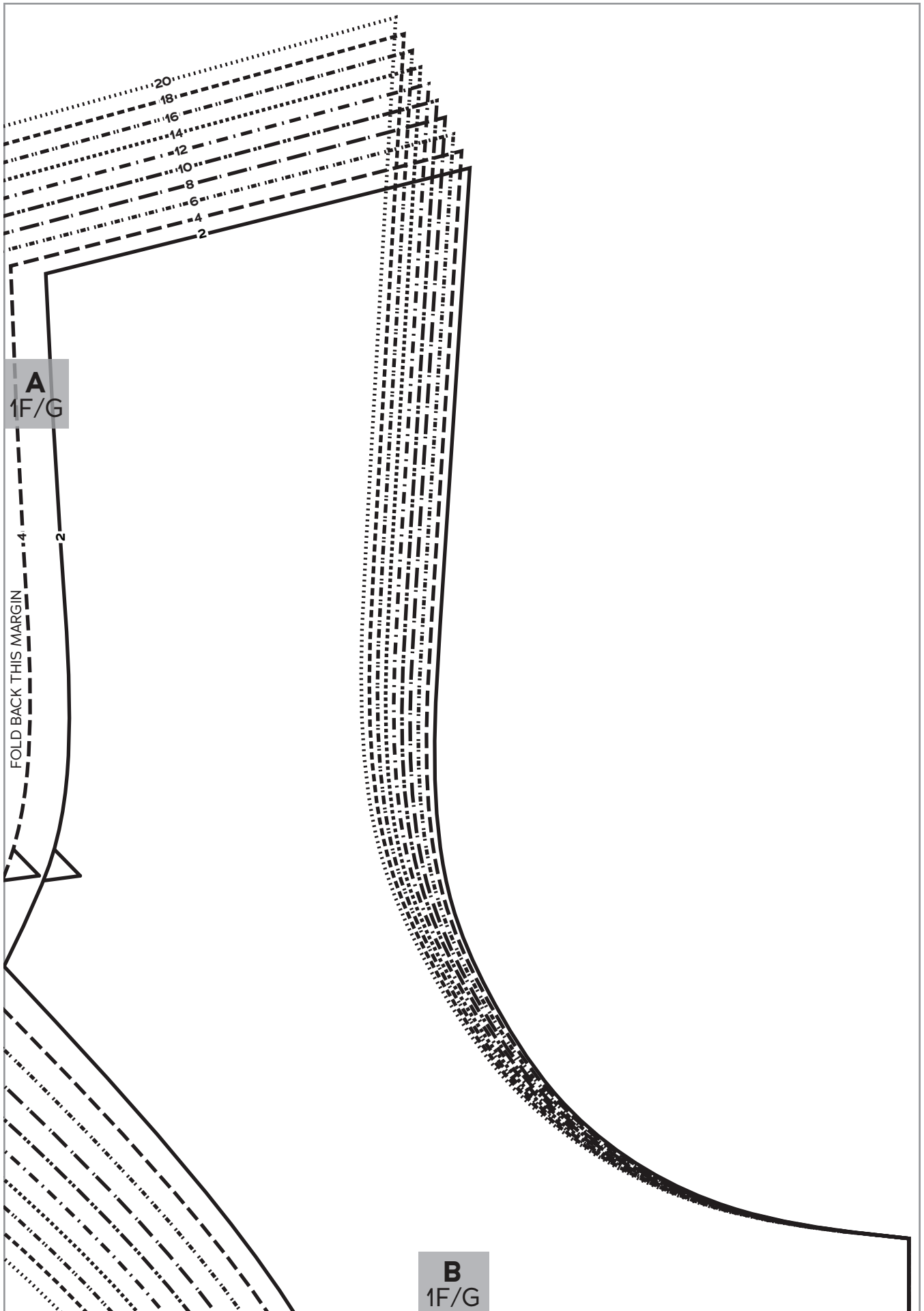

**B**  
7F/G

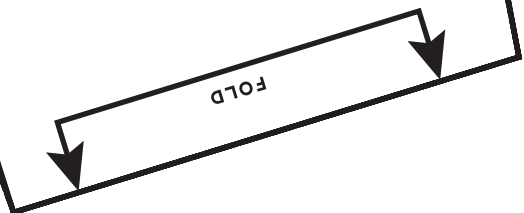



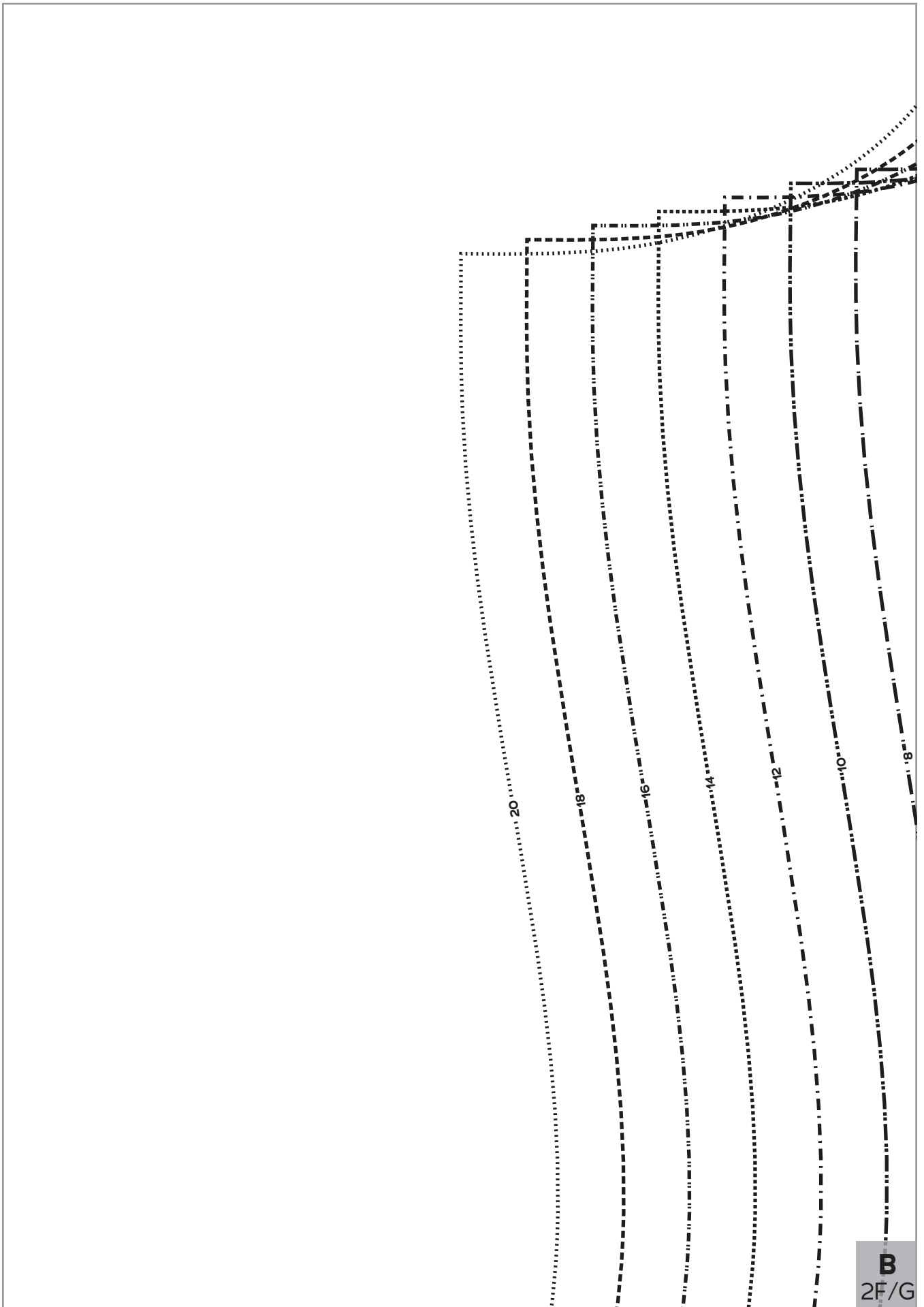

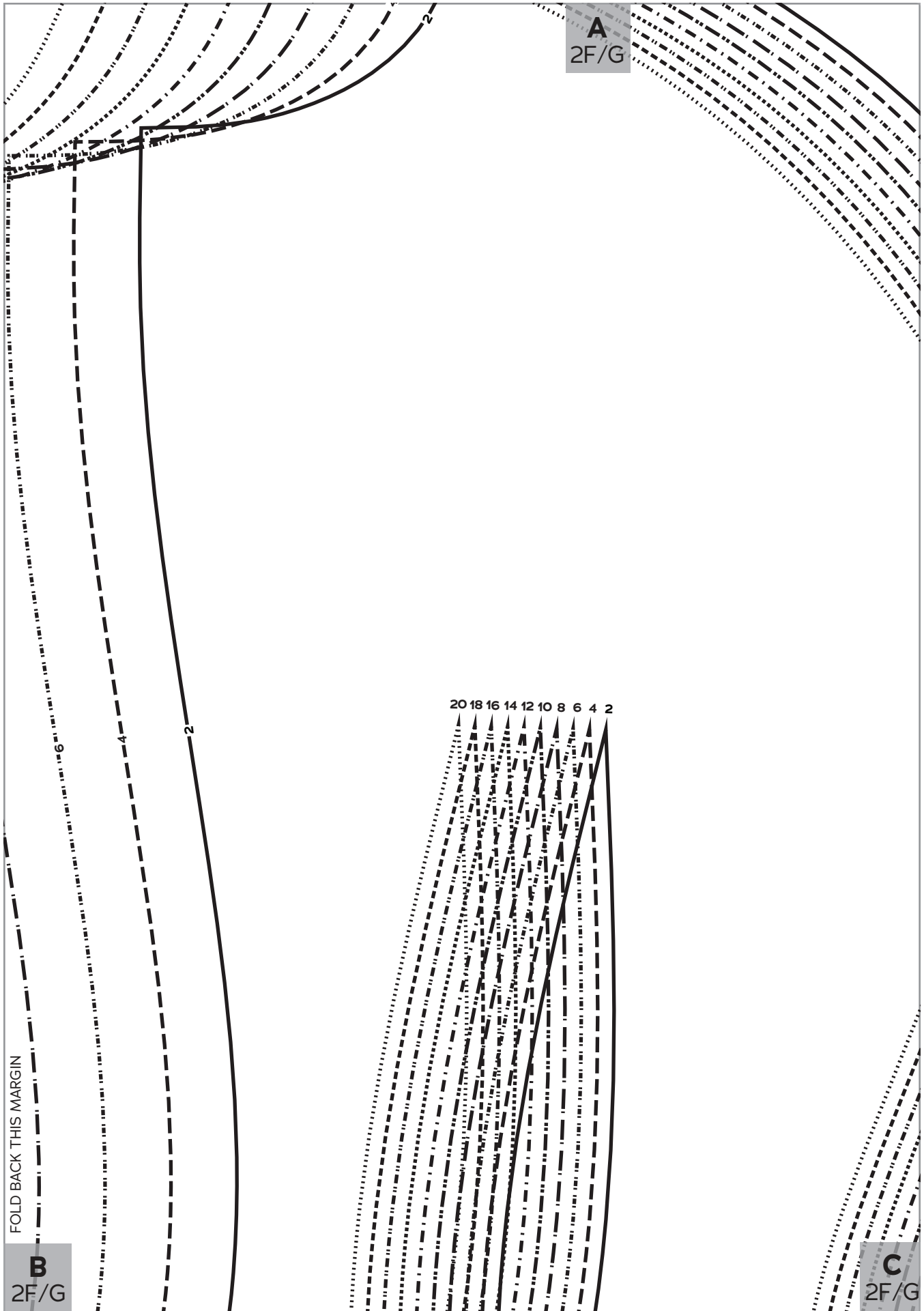

**A**  
2F/G

FOLD BACK THIS MARGIN

**B**  
2F/G

**C**  
2F/G

20 18 16 14 12 10 8 6 4 2

**B**  
1F/G



# CAROUSEL DRESS

SIZES 2-20

**1**

Dress Center Front,  
F/G Cup

Cut 1 fabric on fold

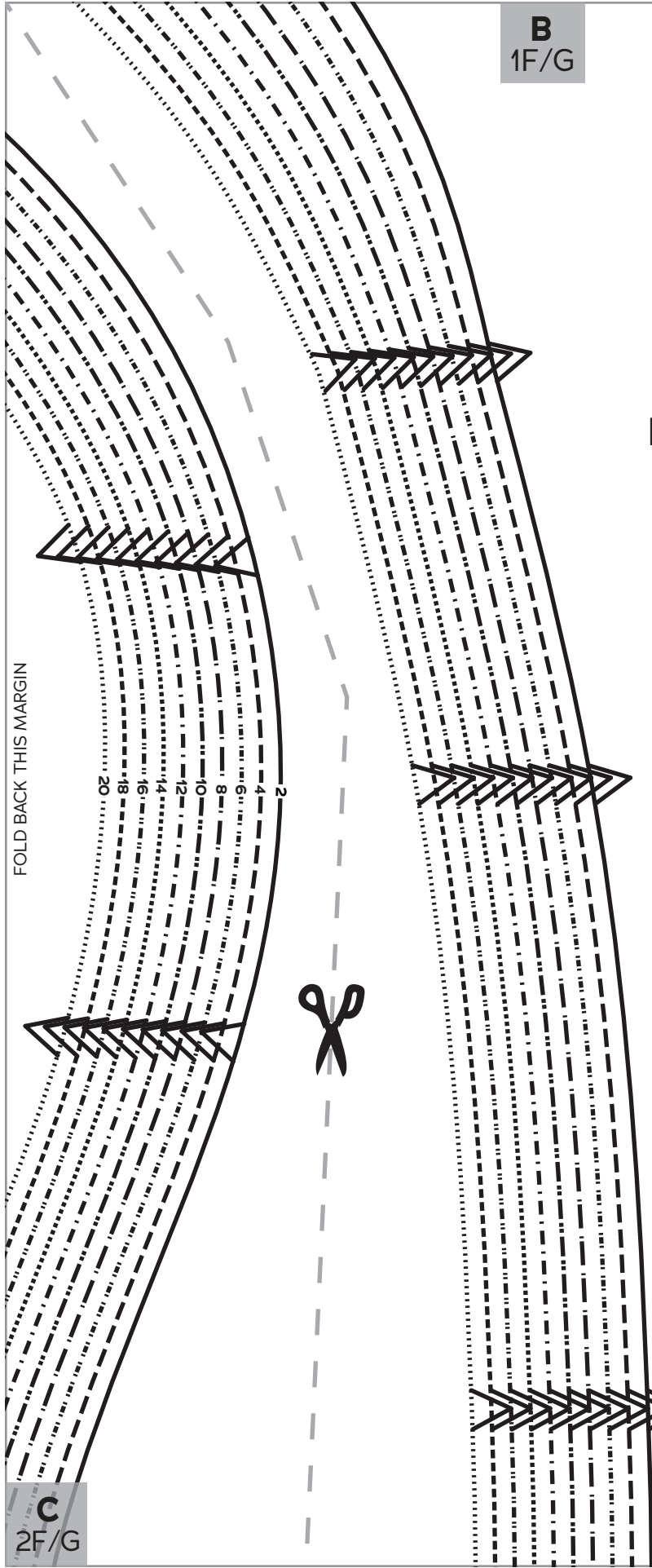

FOLD BACK THIS MARGIN

2  
4  
6  
8  
10  
12  
14  
16  
18  
20



**C**  
2F/G

**C**  
1F/G

FOLD BACK THIS MARGIN

**B**  
2F/G

GRAINLINE

**D**  
2F/G

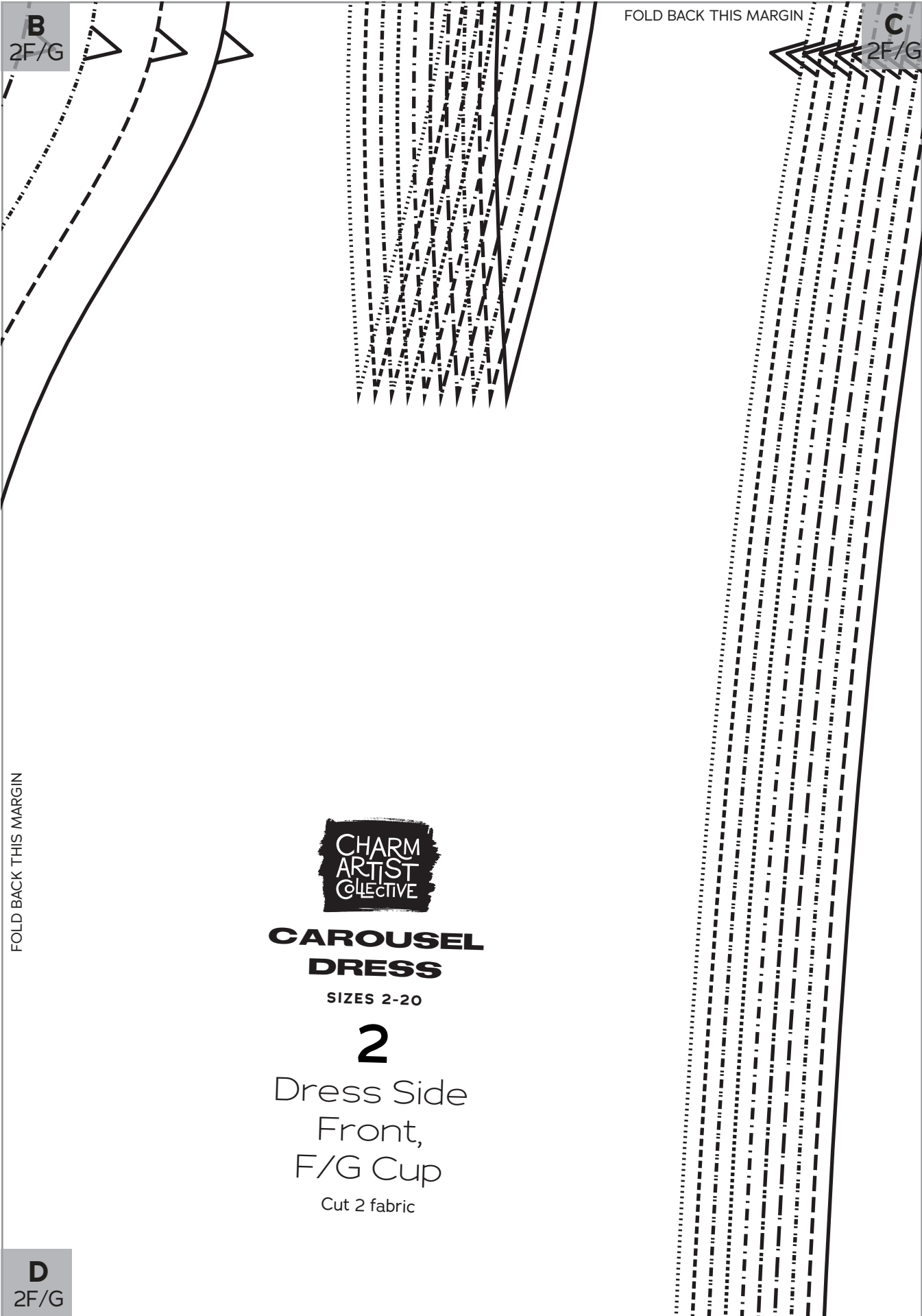

FOLD BACK THIS MARGIN

FOLD BACK THIS MARGIN

**B**  
2F/G

**C**  
2F/G



**CAROUSEL  
DRESS**

SIZES 2-20

**2**

Dress Side  
Front,  
F/G Cup

Cut 2 fabric

**D**  
2F/G

**C**  
2F/G

FOLD BACK THIS MARGIN



20  
18  
16  
14  
12  
10  
8  
6  
4  
2

FOLD BACK THIS MARGIN

**C**  
1F/G

FOLD

**D**  
1F/G

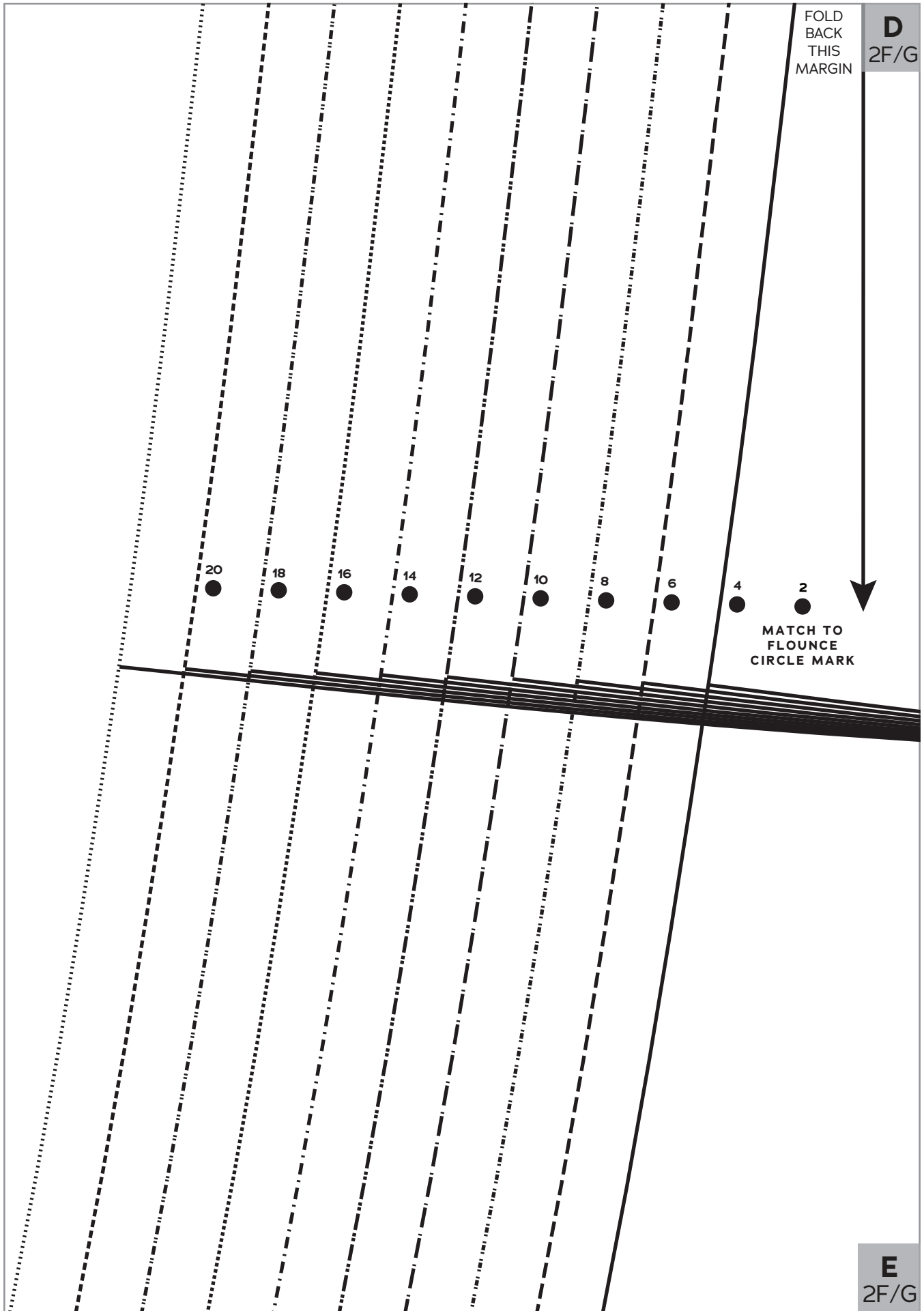

FOLD  
BACK  
THIS  
MARGIN

**D**  
2F/G

20

18

16

14

12

10

8

6

4

2

MATCH TO  
FLOUNCE  
CIRCLE MARK

**E**  
2F/G

**D**  
2F/G

FOLD BACK THIS MARGIN

FOLD BACK THIS MARGIN



**E**  
2F/G



FOLD BACK THIS MARGIN

**D**  
1F/G

FLOUNCE DRESS CUTTING LINE

**E**  
1F/G

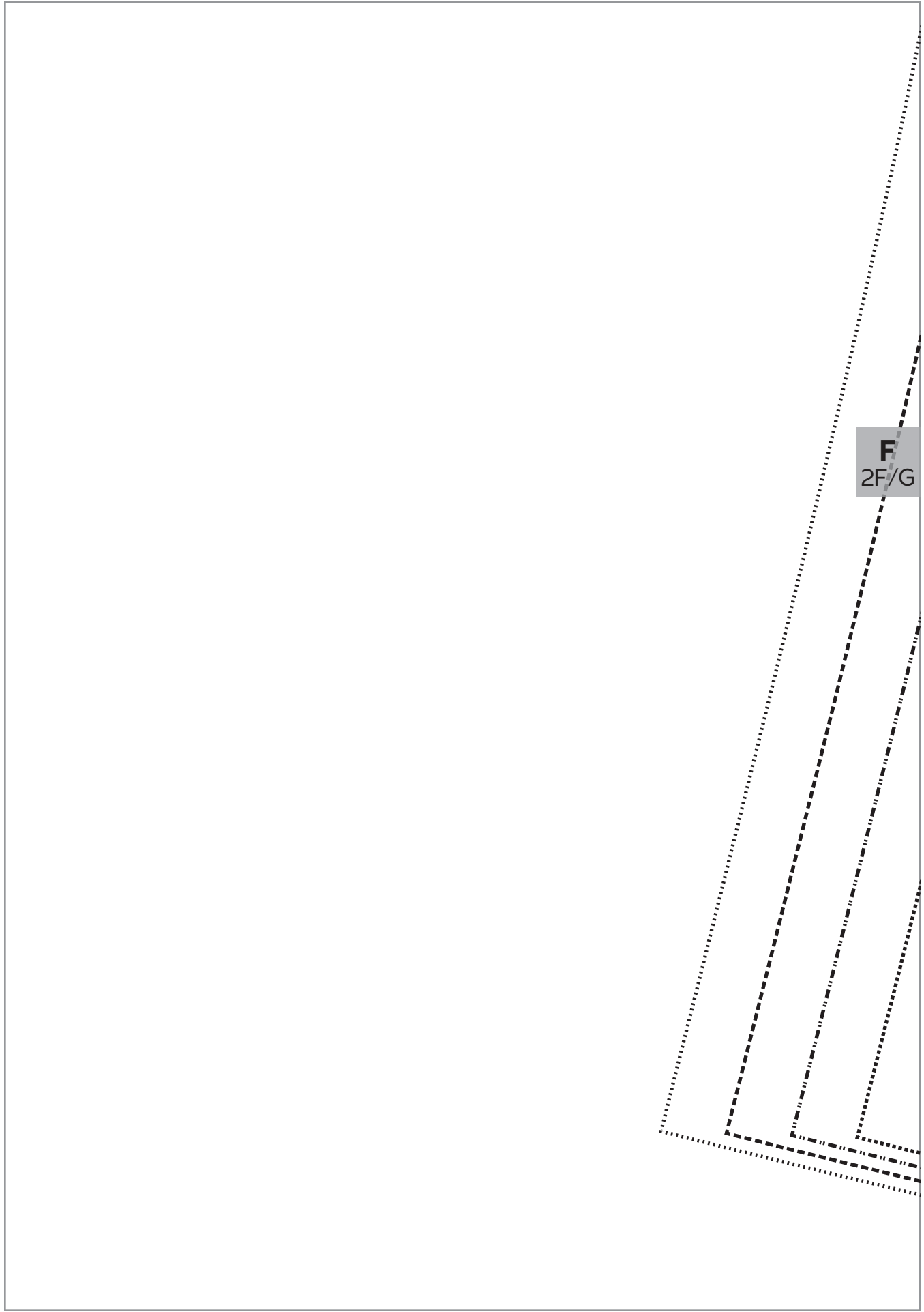

**F**  
2F/G

FOLD BACK THIS MARGIN

**E**  
2F/G

**F**  
2F/G

FOLD BACK THIS MARGIN

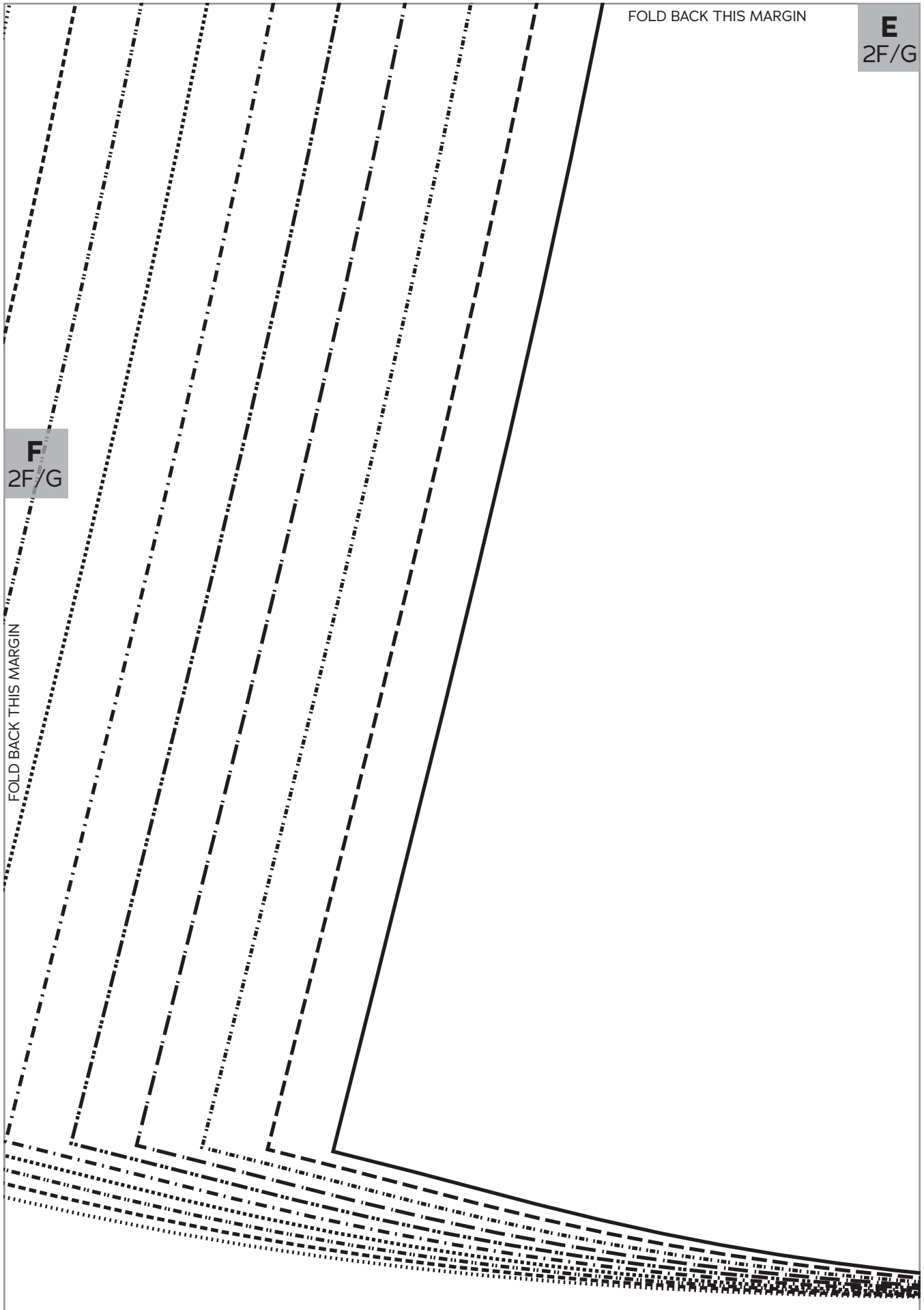

**E**  
2F/G

FOLD BACK THIS MARGIN

FOLD BACK THIS MARGIN



**F**  
1F/G

FOLD BACK THIS MARGIN

FOLD BACK THIS MARGIN

**E**  
1F/G

**F**  
1F/G

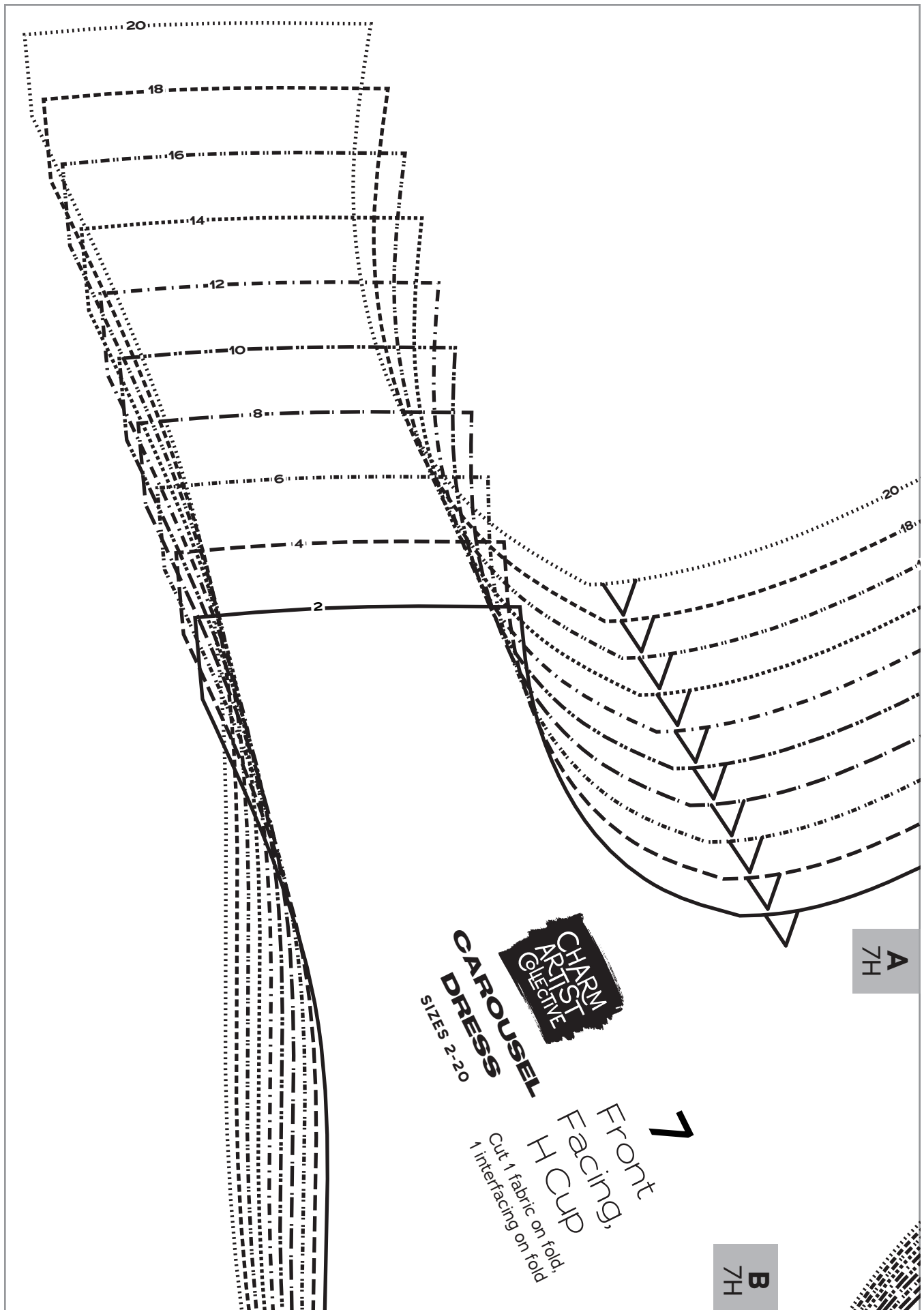

**CHARM ARTISTS COLLECTIVE**  
**CAROUSEL DRESS**  
SIZES 2-20

7  
Front Facing,  
H Cup  
cut 1 fabric on fold,  
1 interfacing on fold

A  
7H

B  
7H

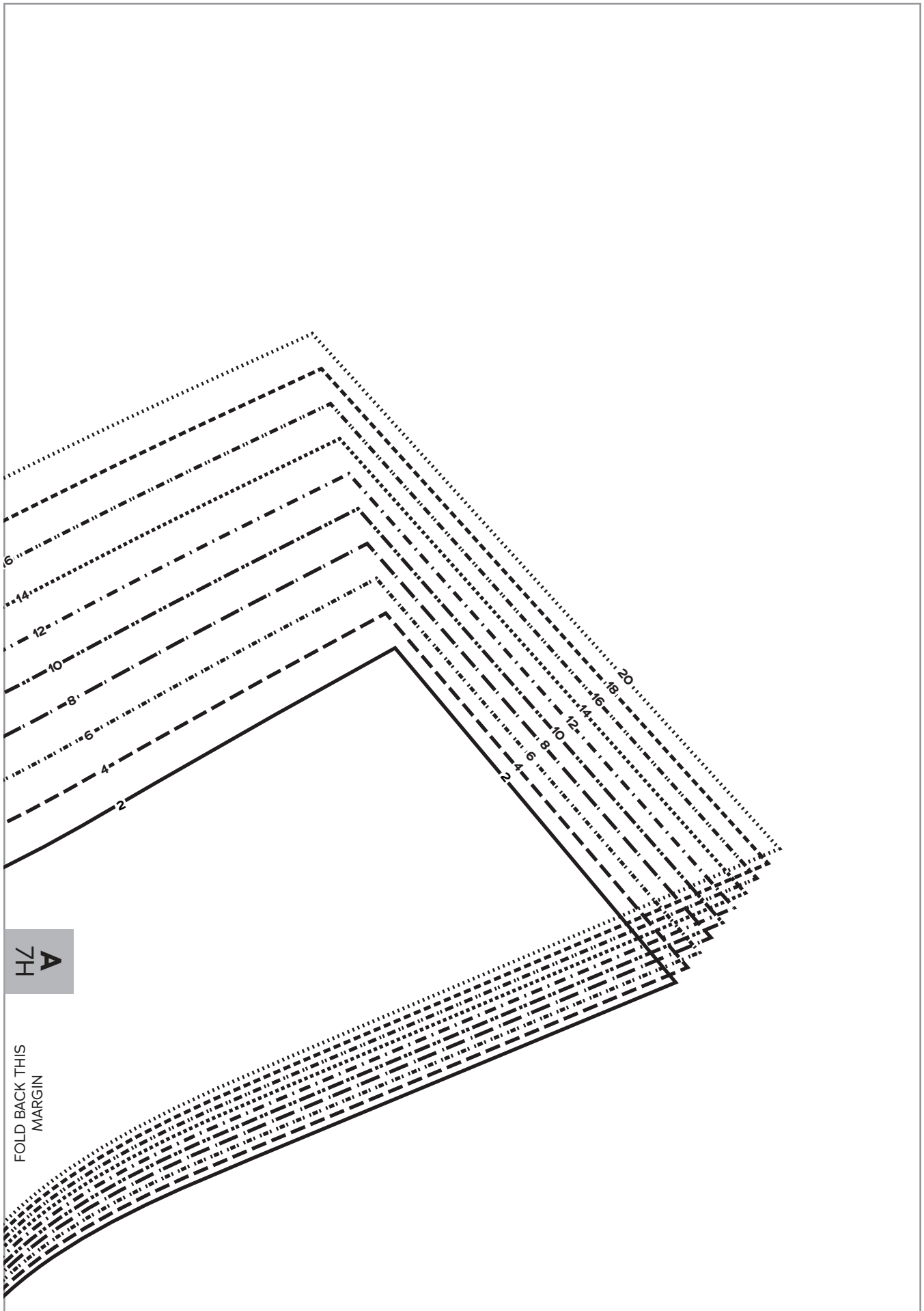

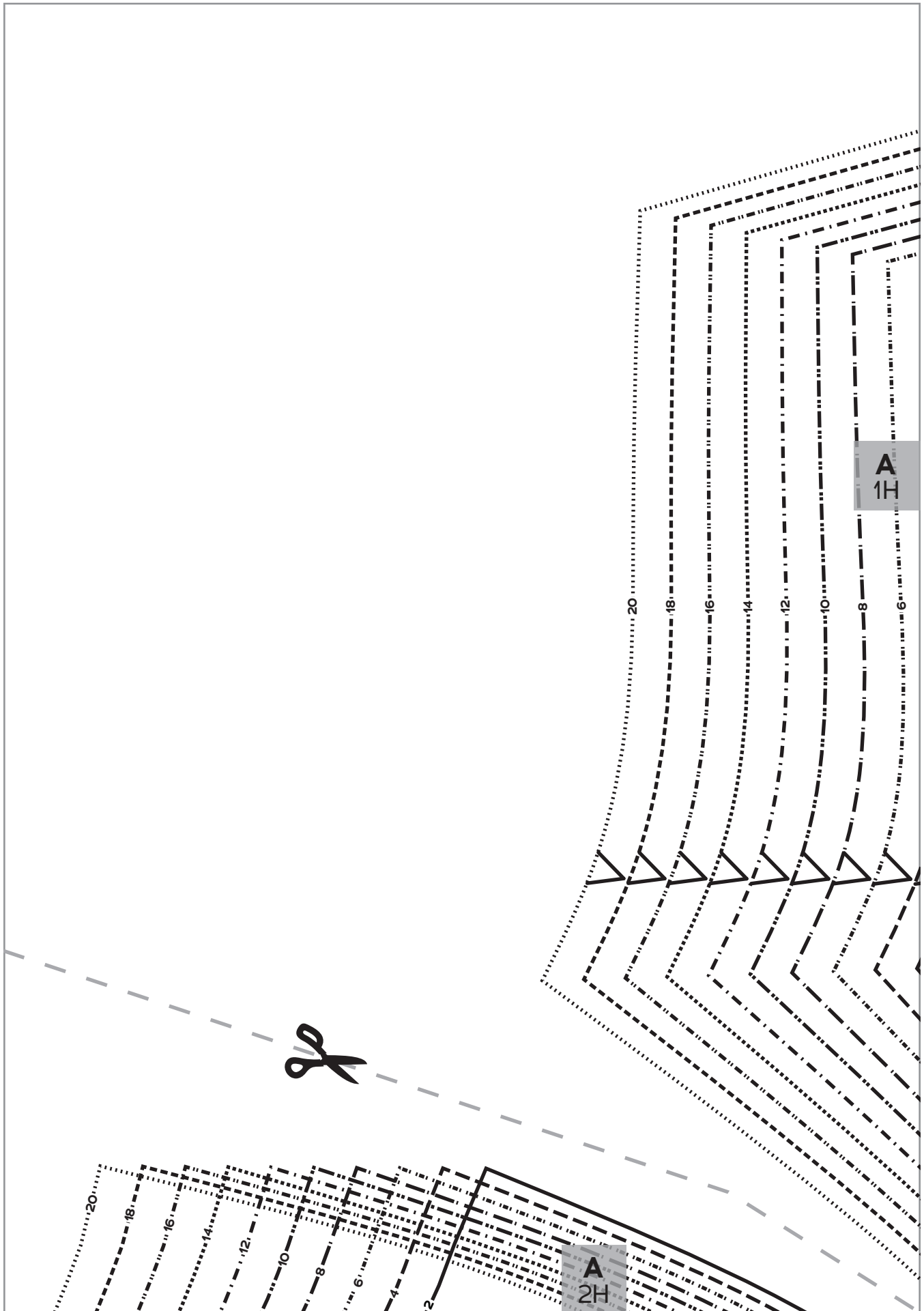



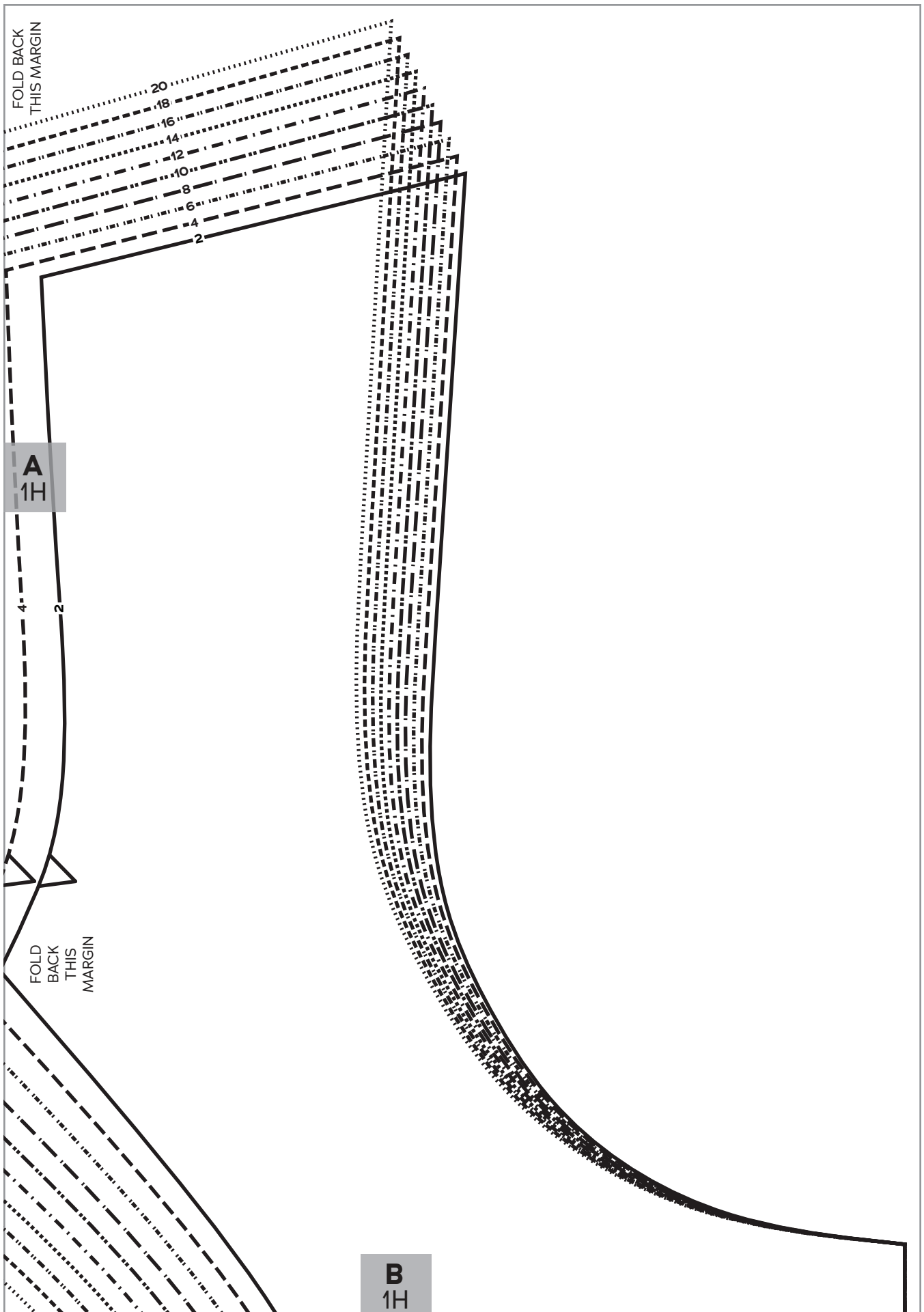

FOLD BACK THIS MARGIN

**B**  
7/8

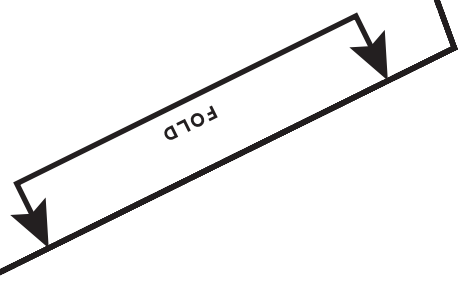

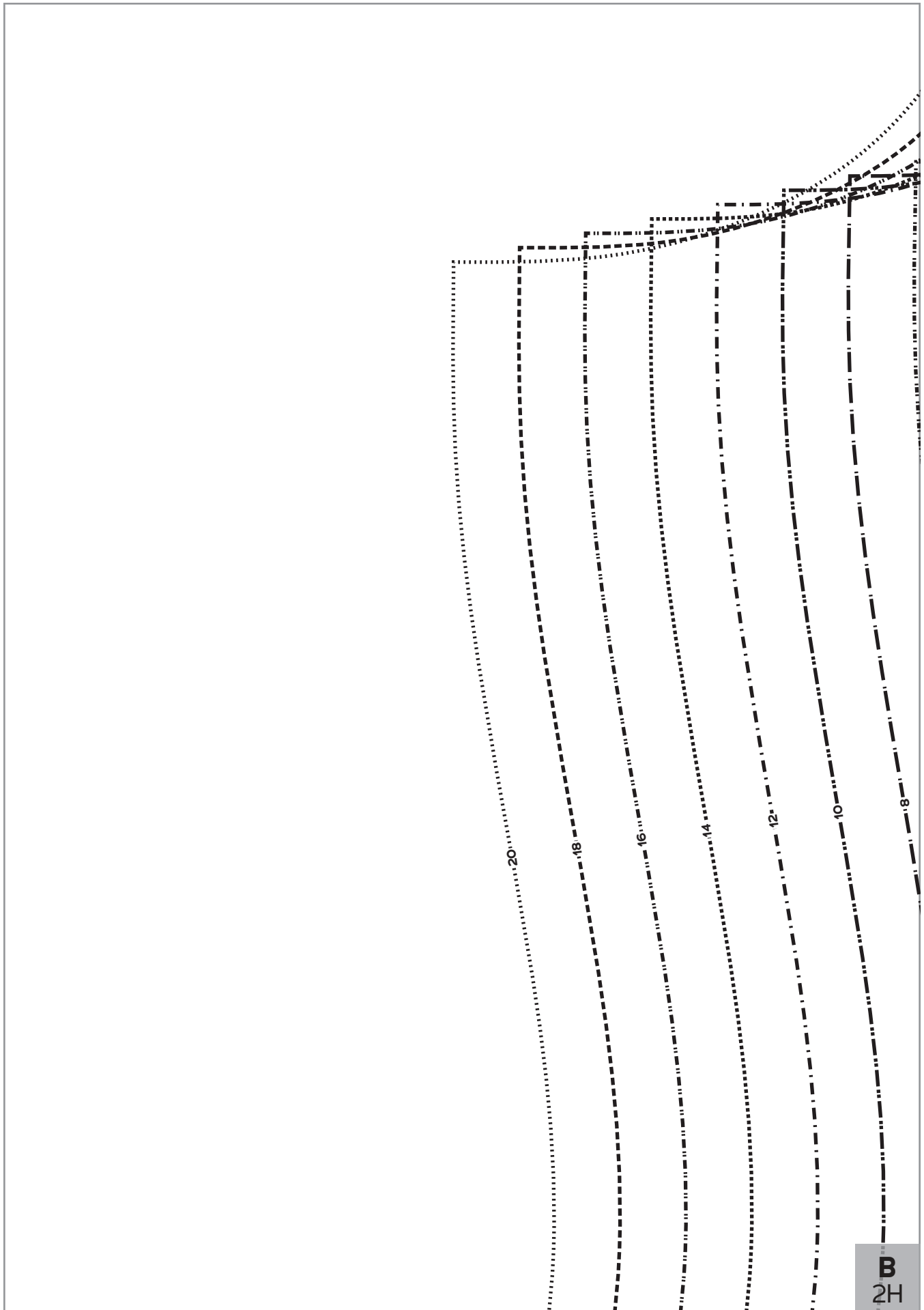

**B**  
2H

FOLD BACK  
THIS MARGIN

**A**  
2H

FOLD BACK THIS MARGIN

20 18 16 14 12 10 8 6 4 2

**B**  
2H

**C**  
2H

B  
1H

FOLD BACK THIS MARGIN



# CAROUSEL DRESS

SIZES 2-20

1

## Dress Center Front, H Cup

Cut 1 fabric on fold



FOLD BACK THIS MARGIN

20

18

16

14

12

10

8

6

4

2



C  
2H

C  
1H

FOLD BACK THIS  
MARGIN

**B**  
2H

**D**  
2H

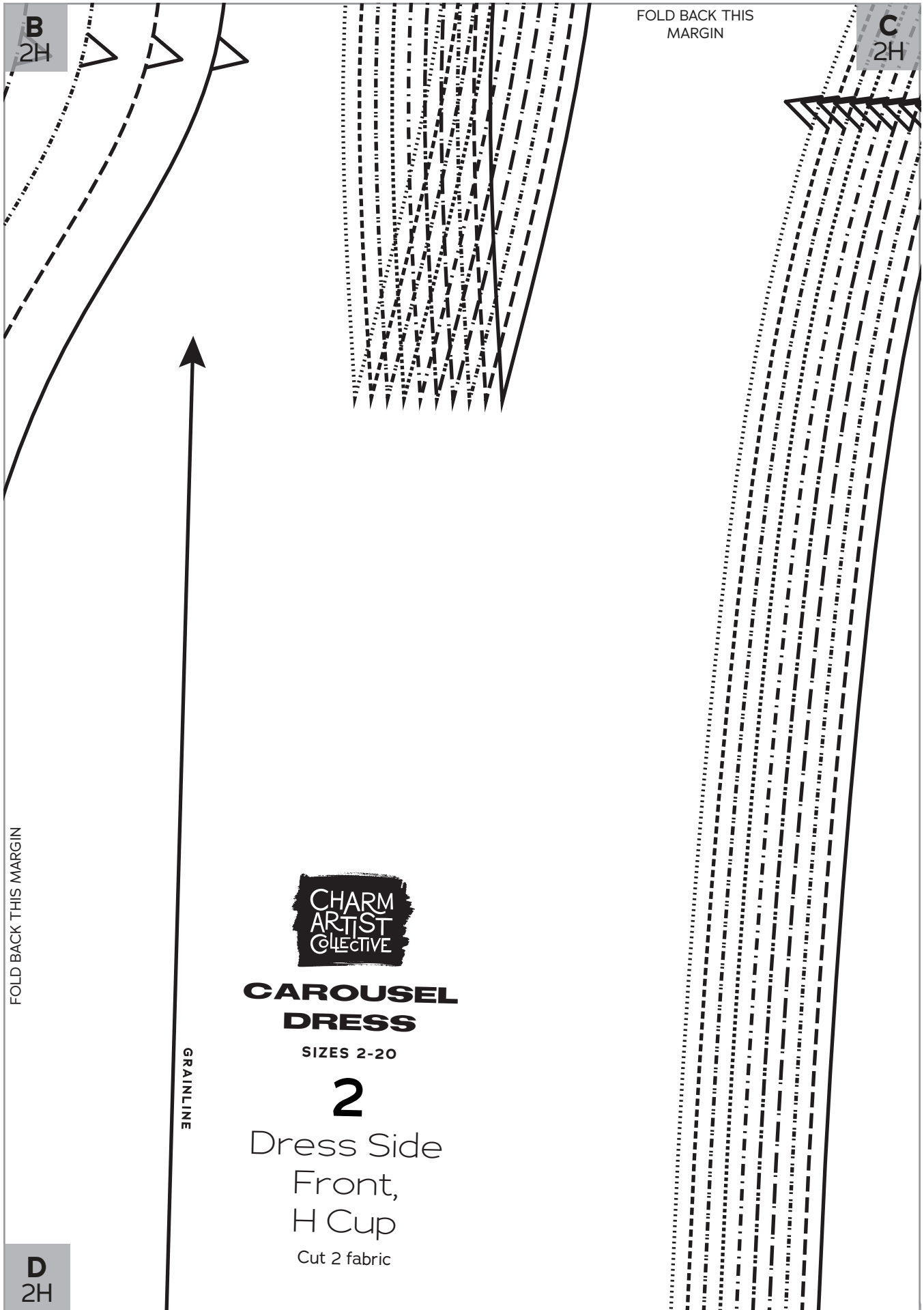

**B**  
2H

**C**  
2H

FOLD BACK THIS MARGIN

FOLD BACK THIS MARGIN

GRAINLINE



**CAROUSEL  
DRESS**

SIZES 2-20

**2**

Dress Side  
Front,  
H Cup

Cut 2 fabric

**D**  
2H

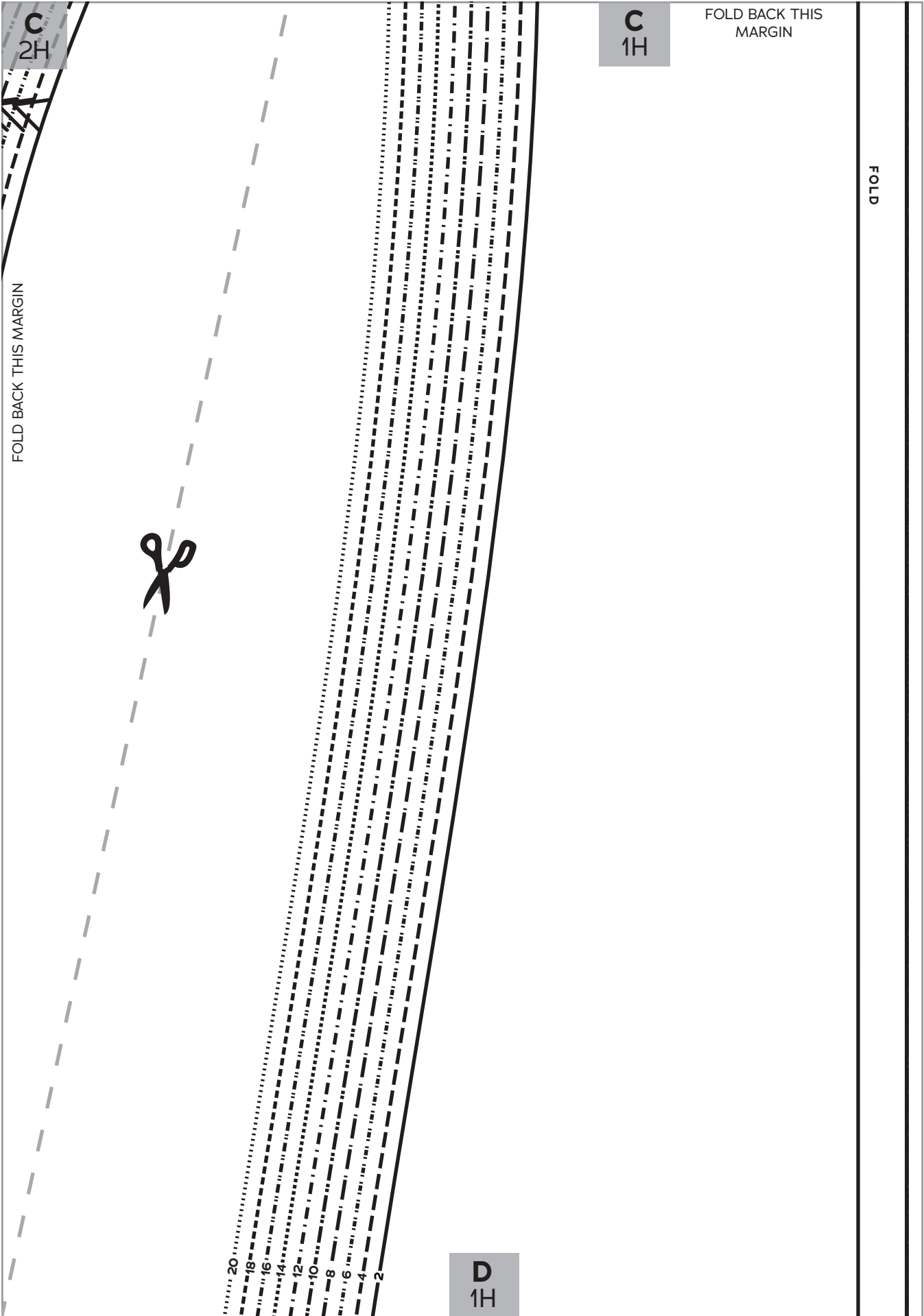

FOLD BACK THIS MARGIN

C  
2H



20  
18  
16  
14  
12  
10  
8  
6  
4  
2

D  
1H

C  
1H

FOLD BACK THIS MARGIN

FOLD



FOLD  
BACK  
THIS  
MARGIN

**D**  
2H

20

18

16

14

12

10

8

6

4

2

MATCH TO  
FLOUNCE  
CIRCLE MARK

**E**  
2H

**D**  
2H

FOLD BACK THIS MARGIN

FOLD BACK THIS MARGIN



FLOUNCE DRESS CUTTING LINE

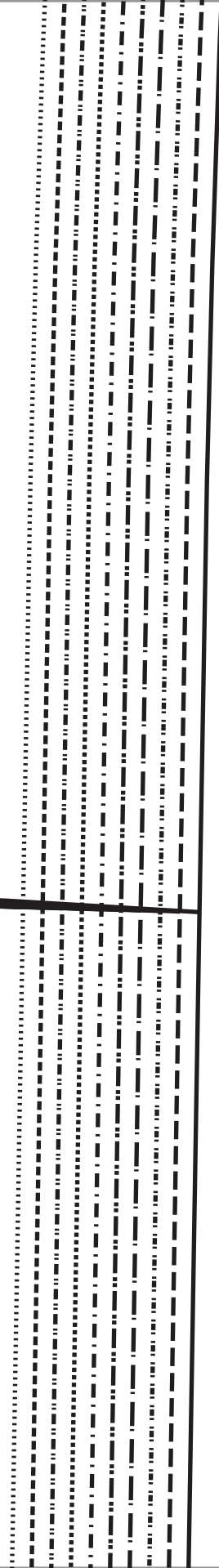

**E**  
2H

**D**  
1H

FOLD BACK THIS MARGIN



FLOUNCE DRESS CUTTING LINE

**E**  
1H

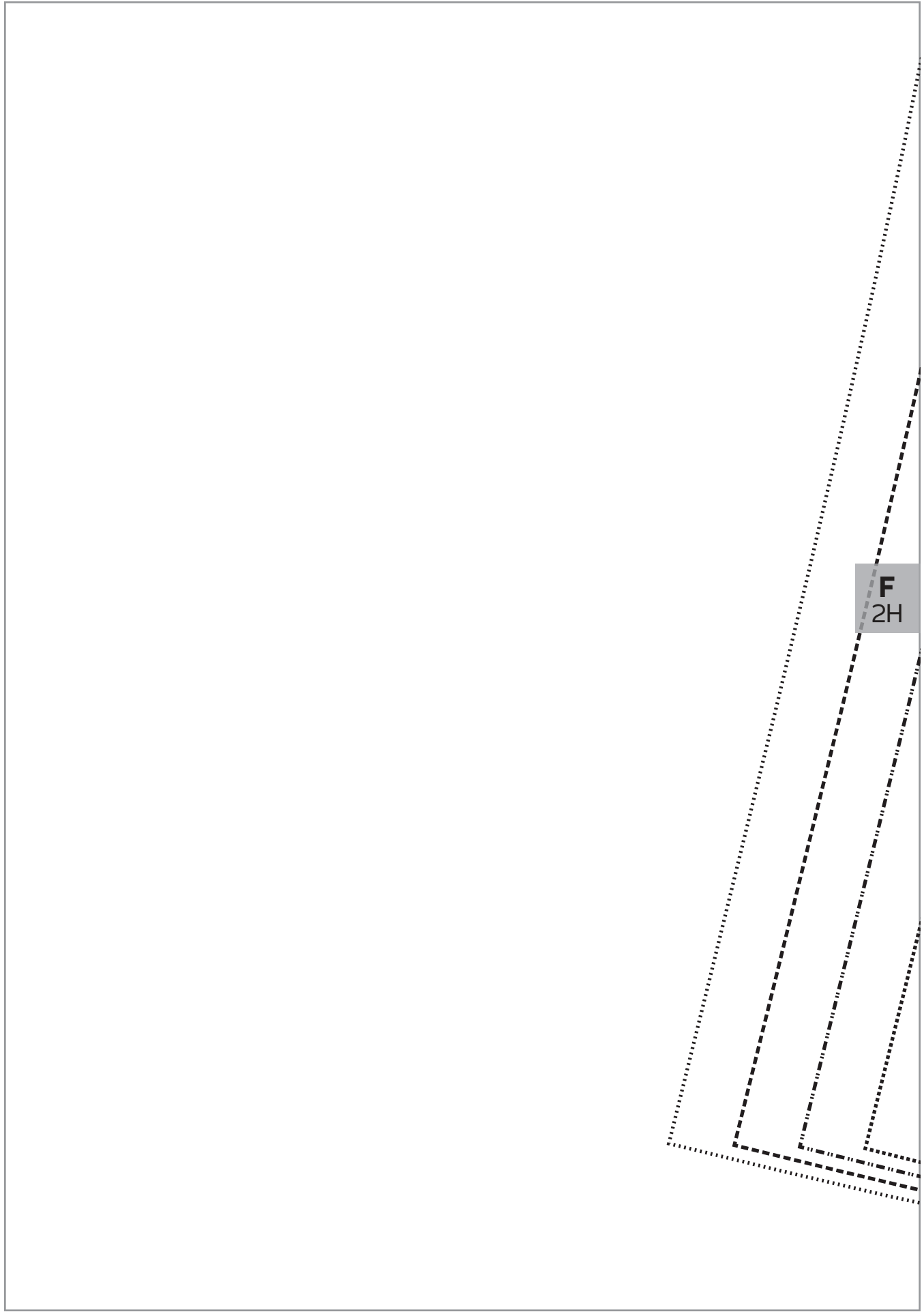

FOLD BACK THIS MARGIN

**E**  
2H

FOLD BACK THIS MARGIN

**F**  
2H

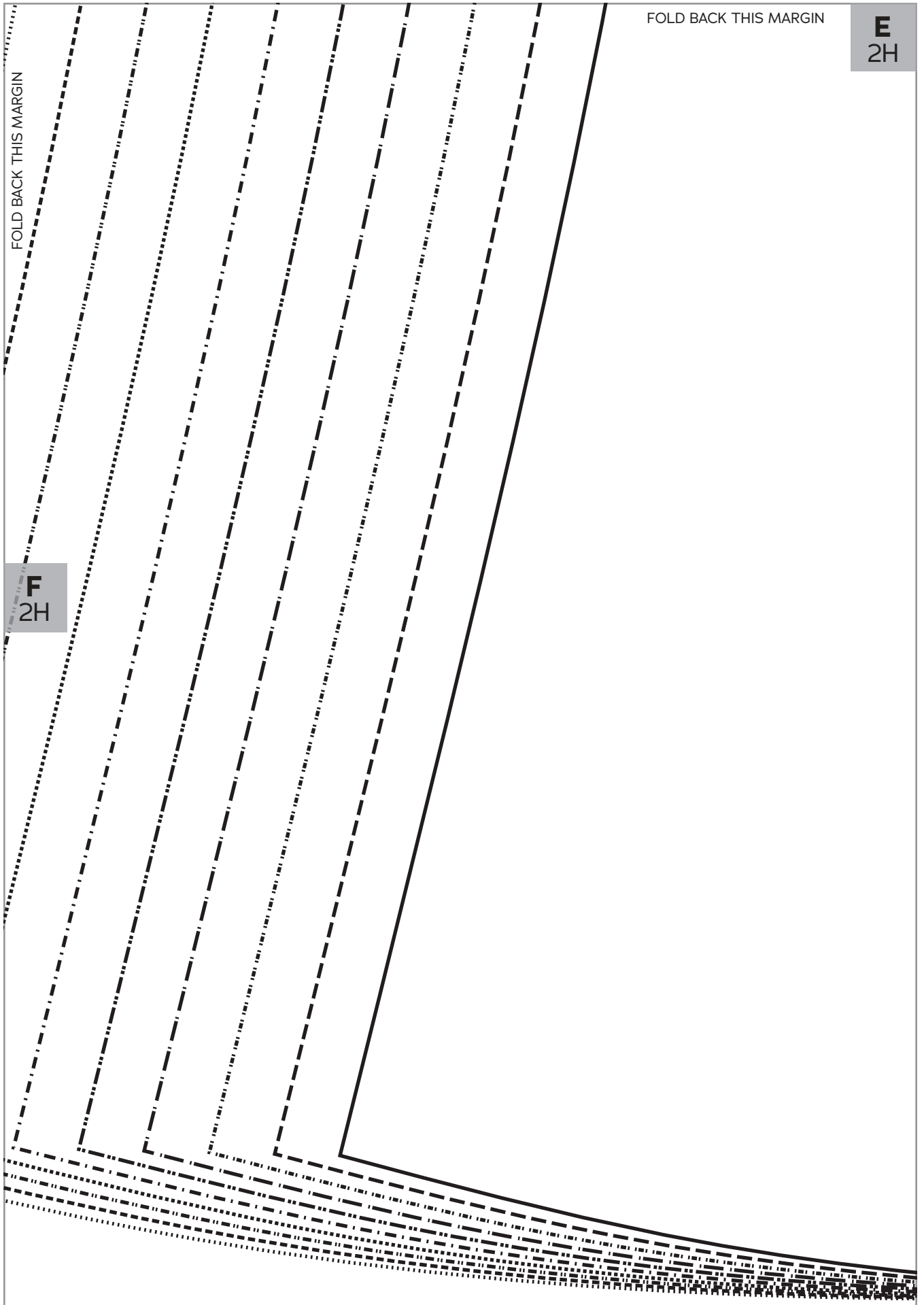

**E**  
2H

FOLD BACK THIS MARGIN

FOLD BACK THIS MARGIN



**F**  
1H

FOLD BACK THIS MARGIN

**E**  
1H

FOLD BACK THIS MARGIN

**F**  
1H

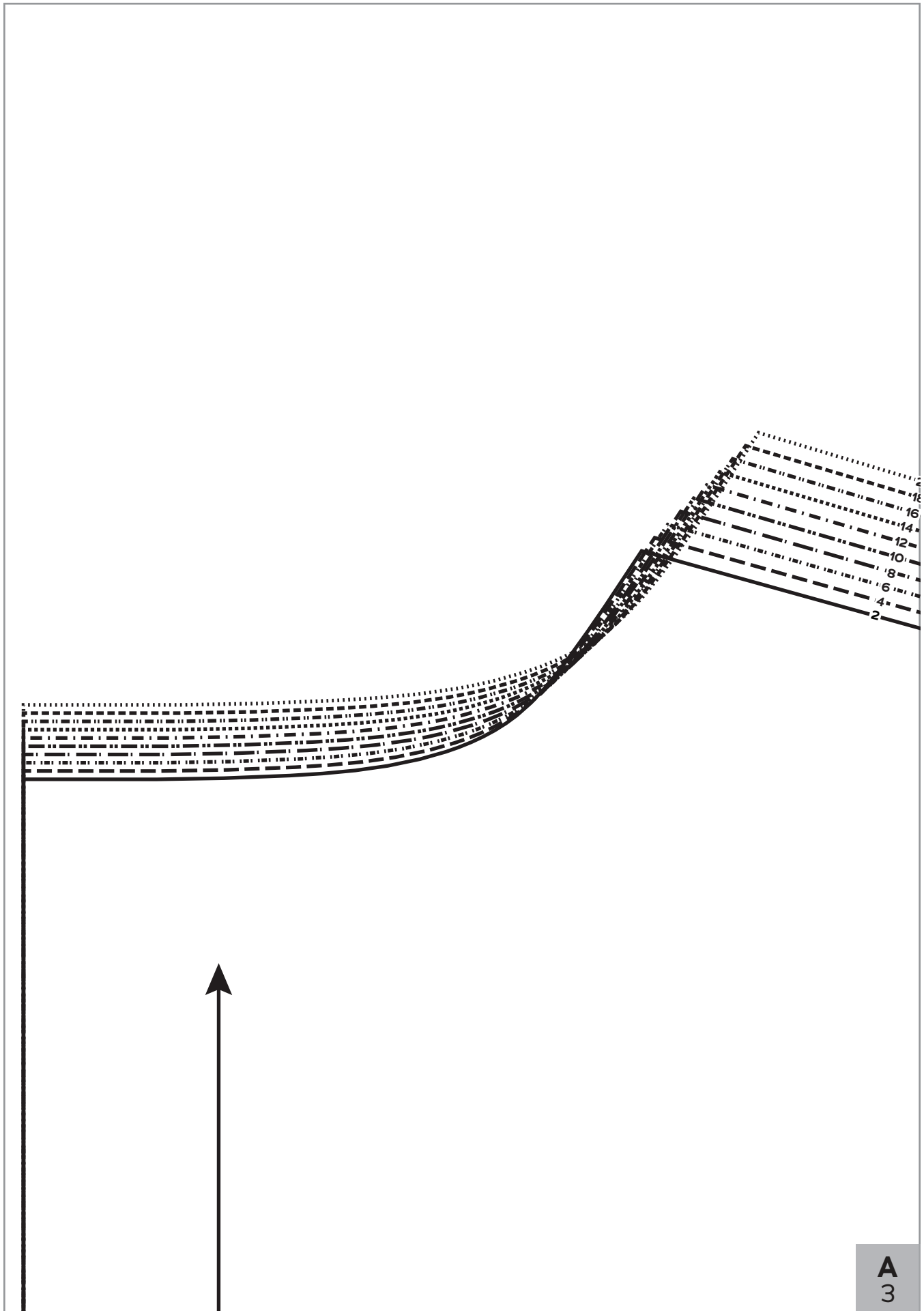



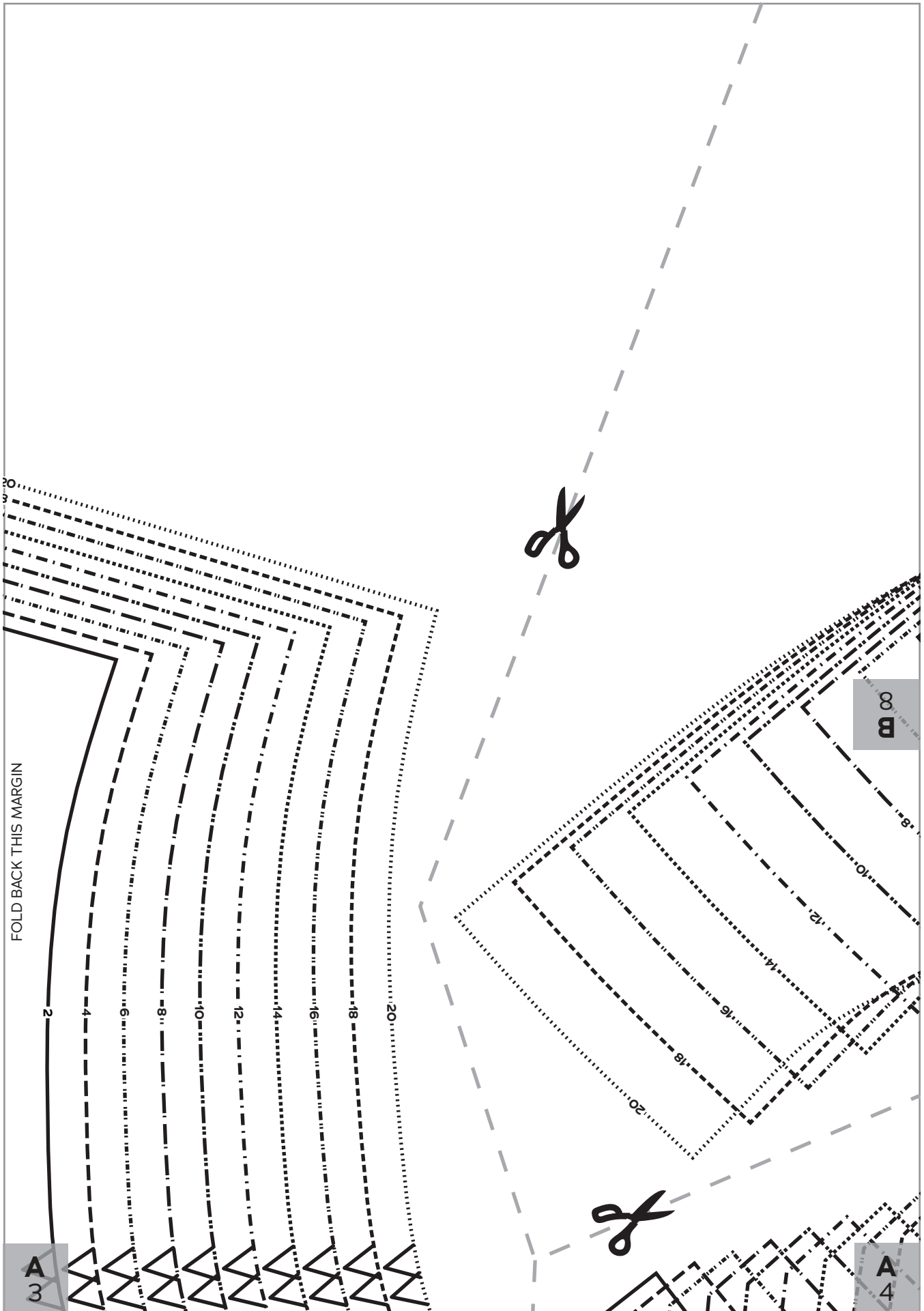

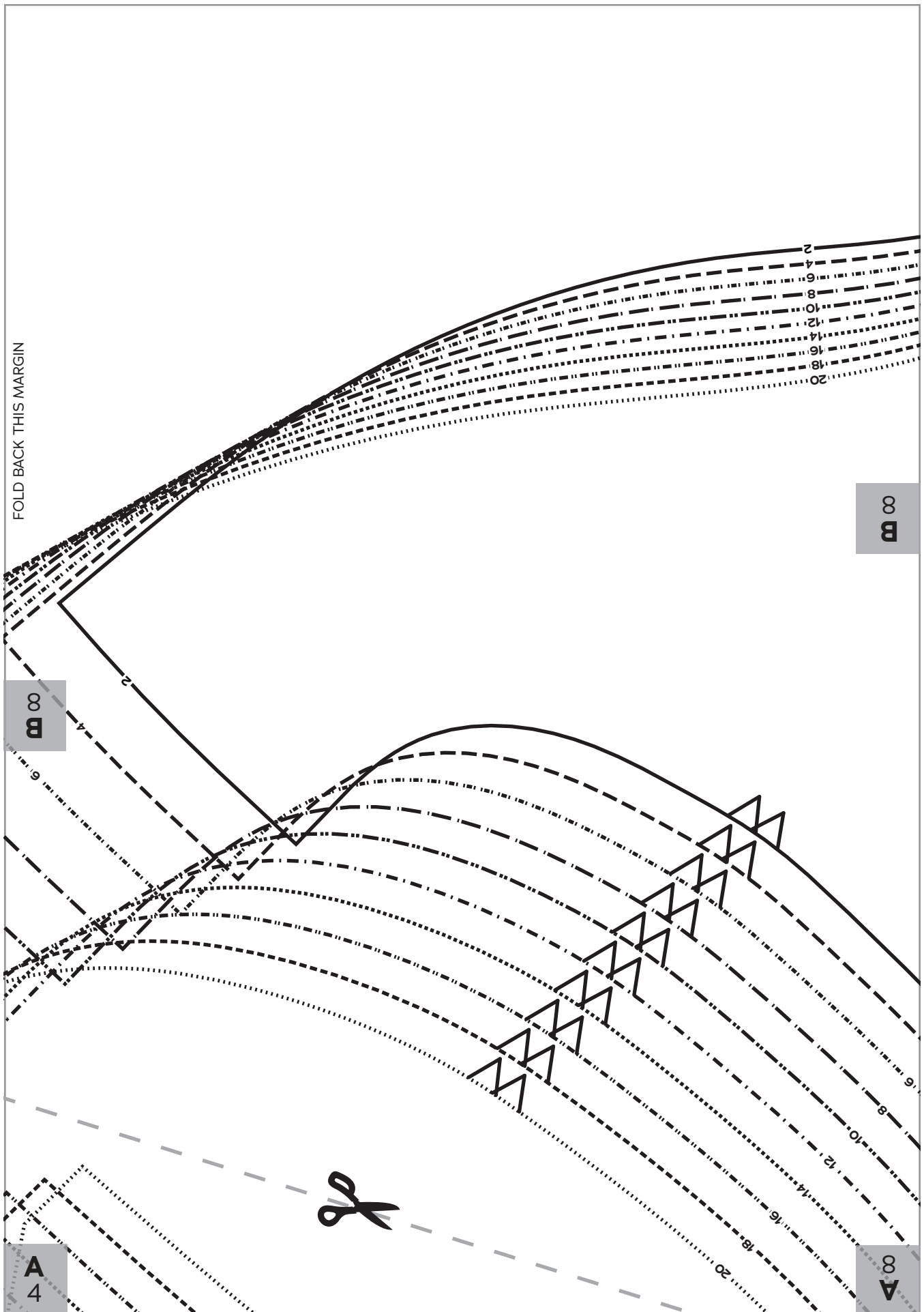

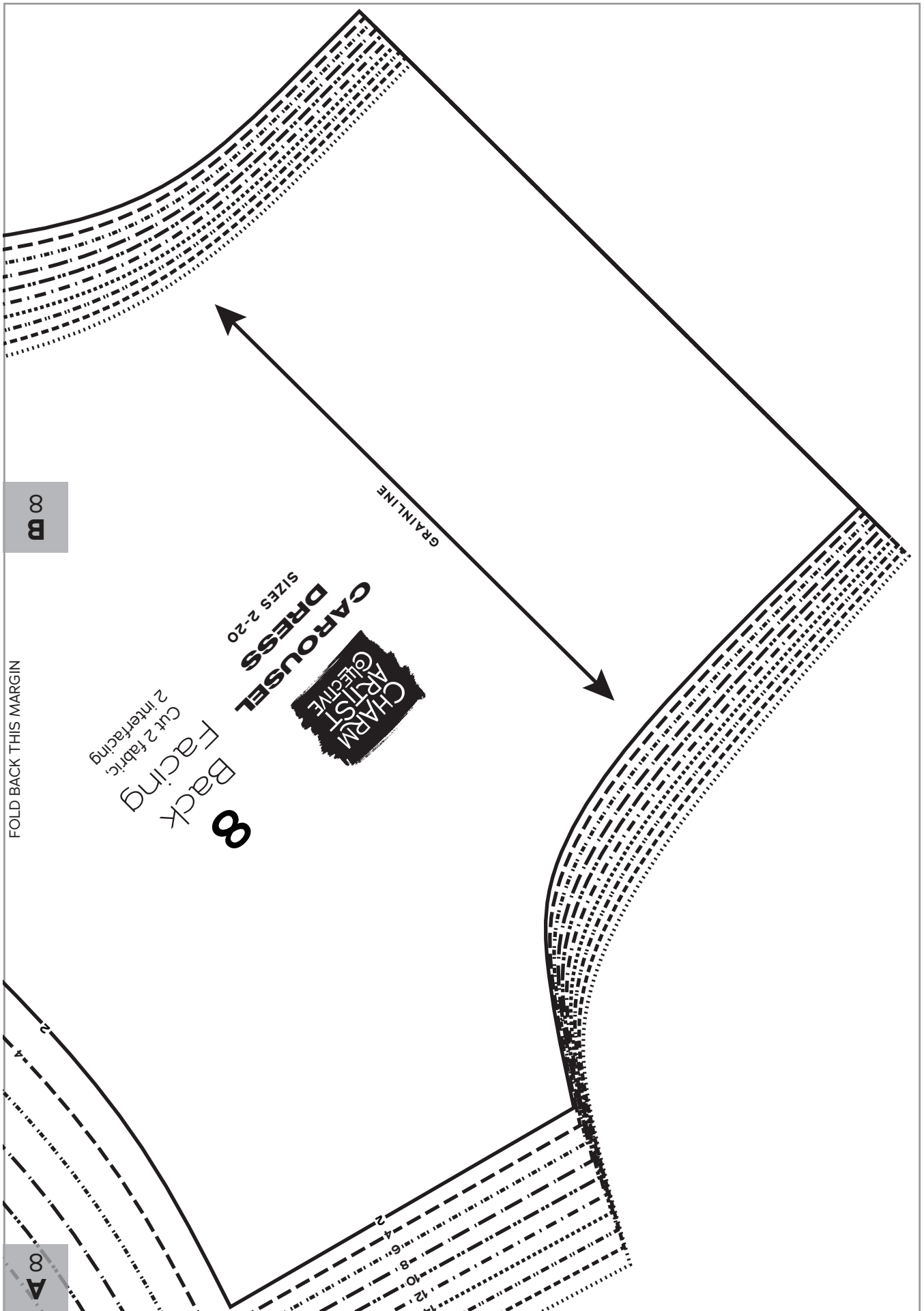

8 B

GRAINLINE

CHARM ARTIST COLLECTIVE  
CAROUSEL DRESS  
SIZES 2-20

8  
Back Facing  
Cut 2 fabric,  
2 interfacing

FOLD BACK THIS MARGIN

8 A

FOLD BACK THIS MARGIN

A  
3



**CAROUSEL  
DRESS**

SIZES 2-20

**3**

Dress  
Center  
Back

Cut 2 fabric

GRAINLINE

B  
3

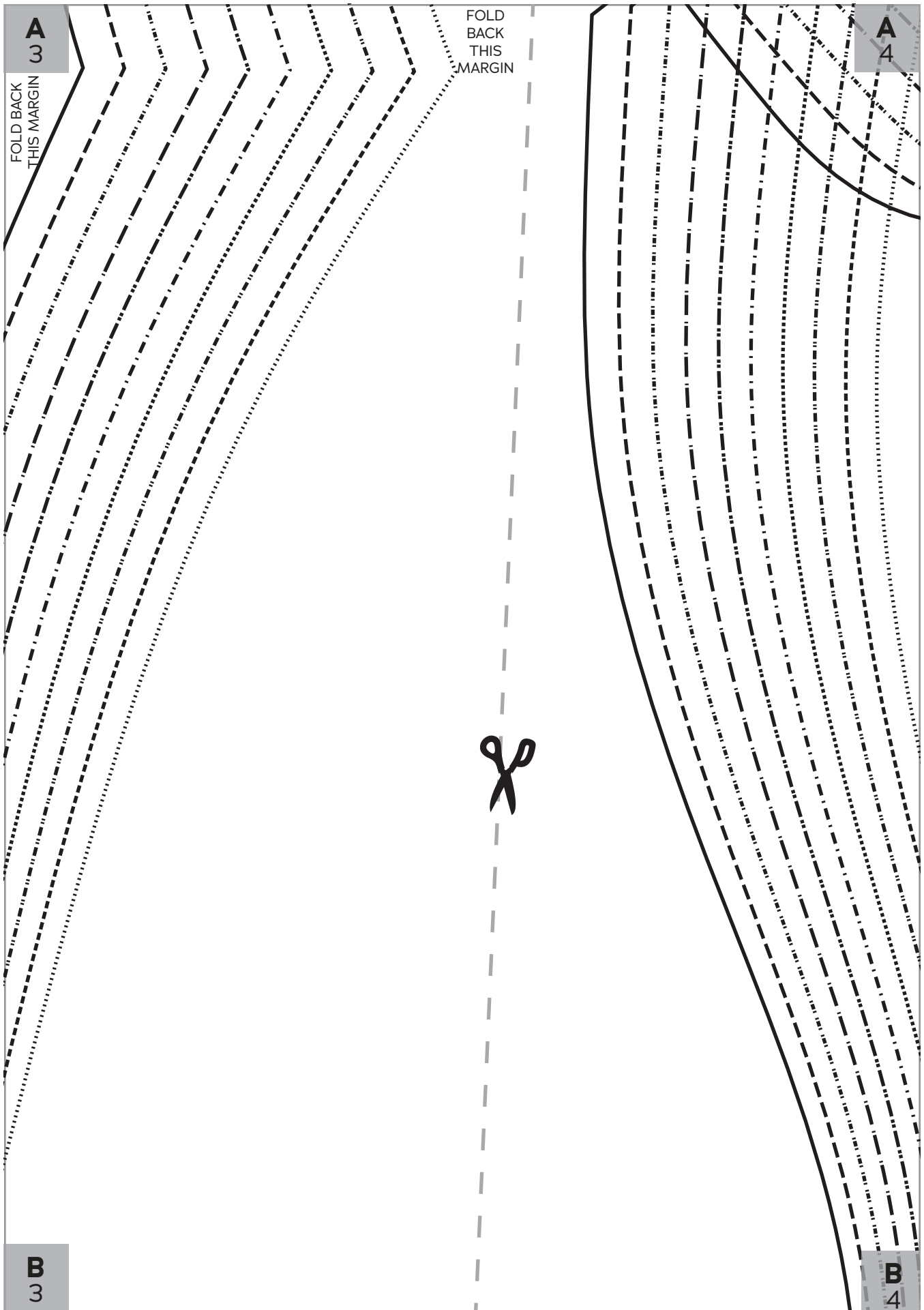

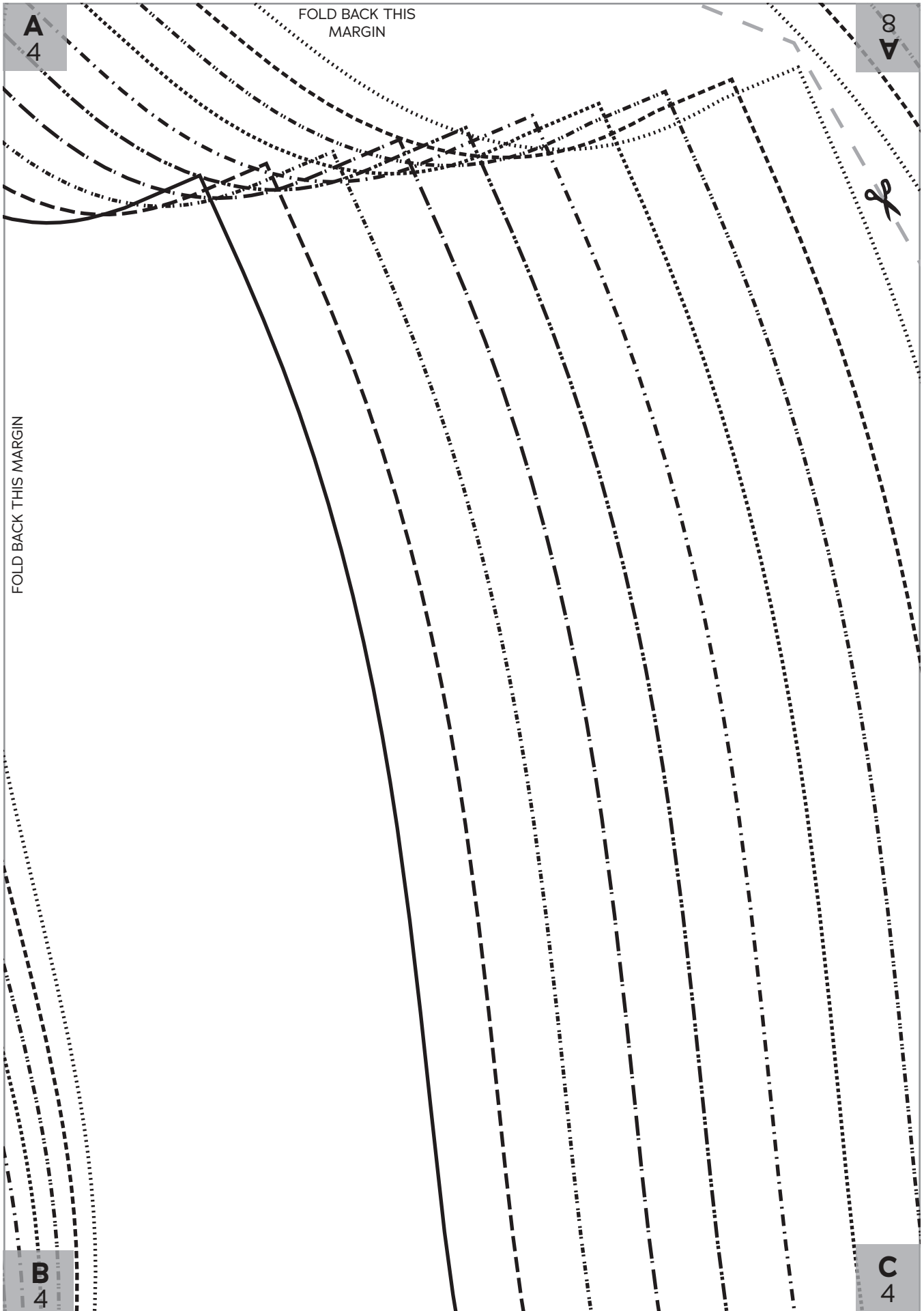

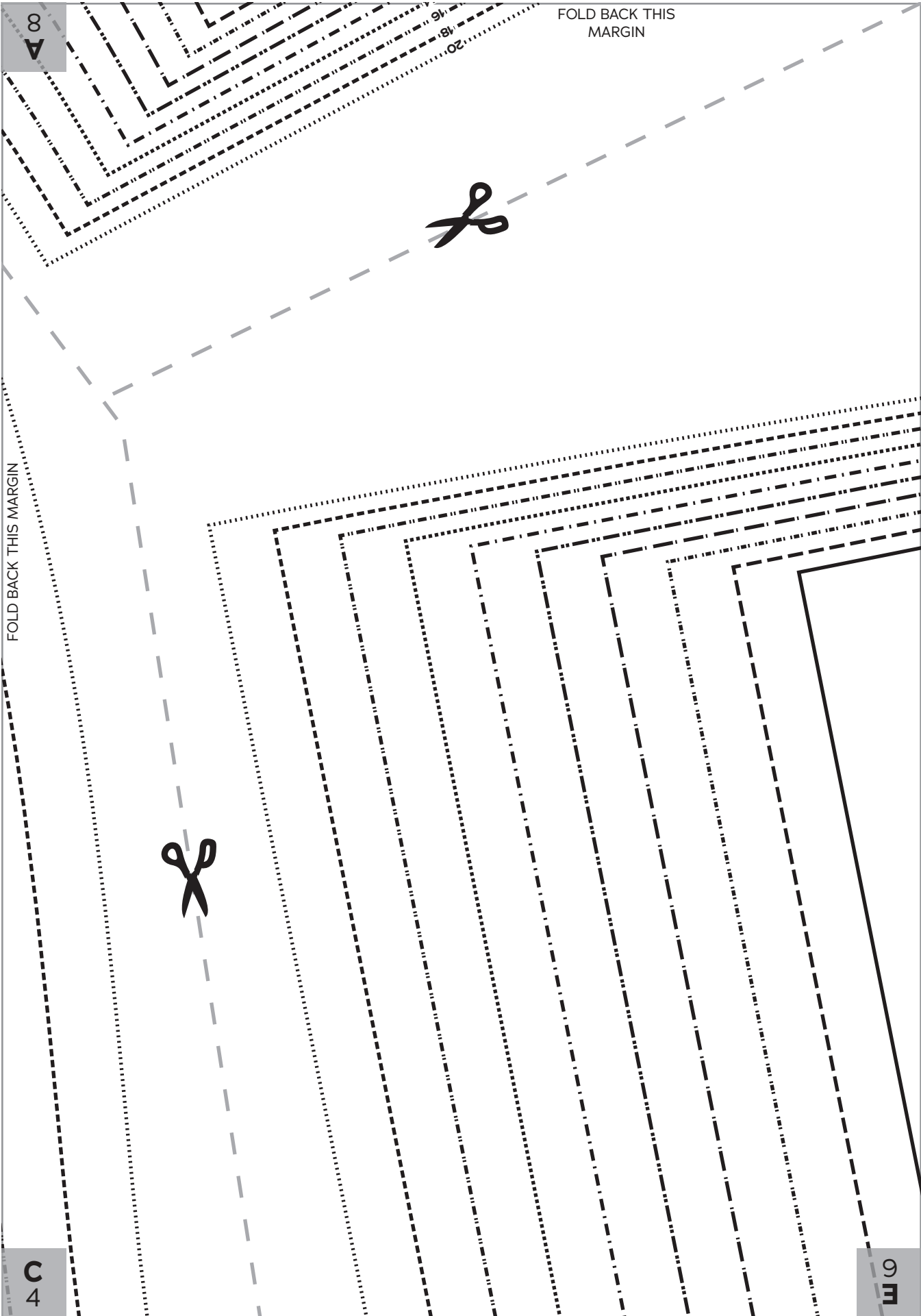

8

A

FOLD BACK THIS MARGIN



FOLD BACK THIS MARGIN



C  
4

E  
9

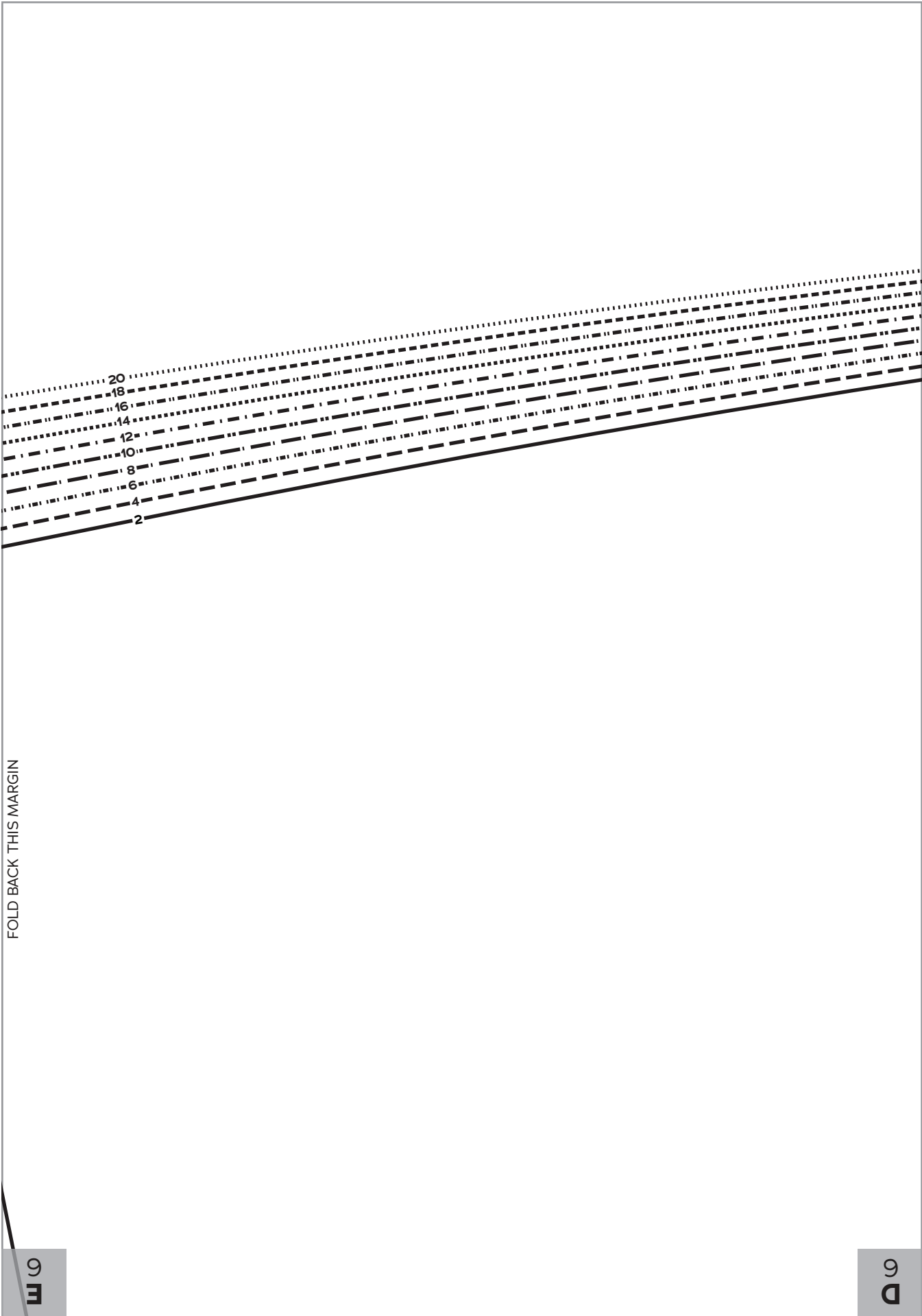

FOLD BACK THIS MARGIN

20  
18  
16  
14  
12  
10  
8  
6  
4  
2





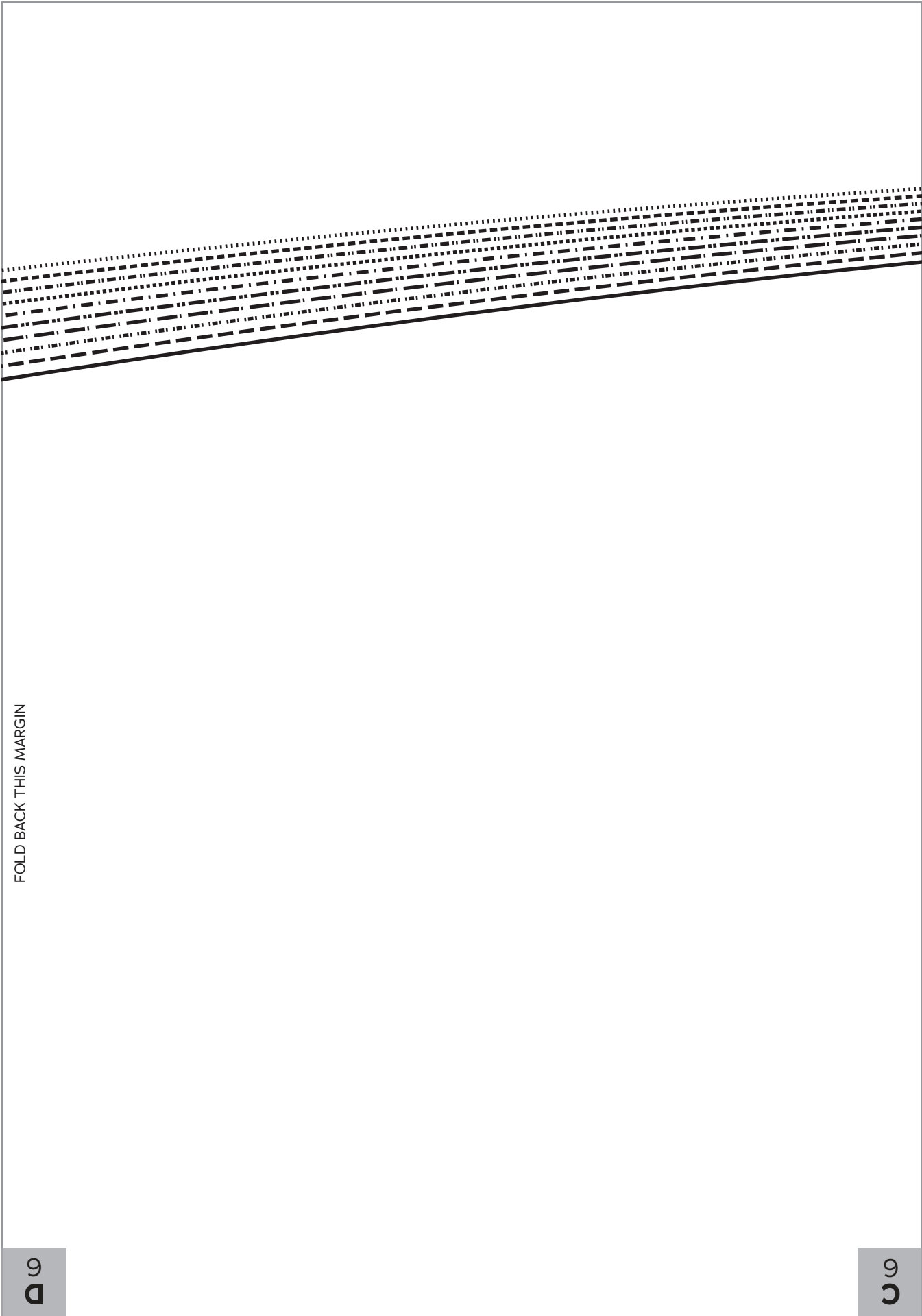

FOLD BACK THIS MARGIN



FOLD BACK THIS MARGIN

Cut 1 fabric on fold,  
2 tulle on fold  
(tulle is optional)  
Flounce  
Back

6

CAROUSEL  
DRESS  
SIZES 2-20



6  
C

6  
B



FOLD BACK THIS MARGIN

9  
B

9  
A

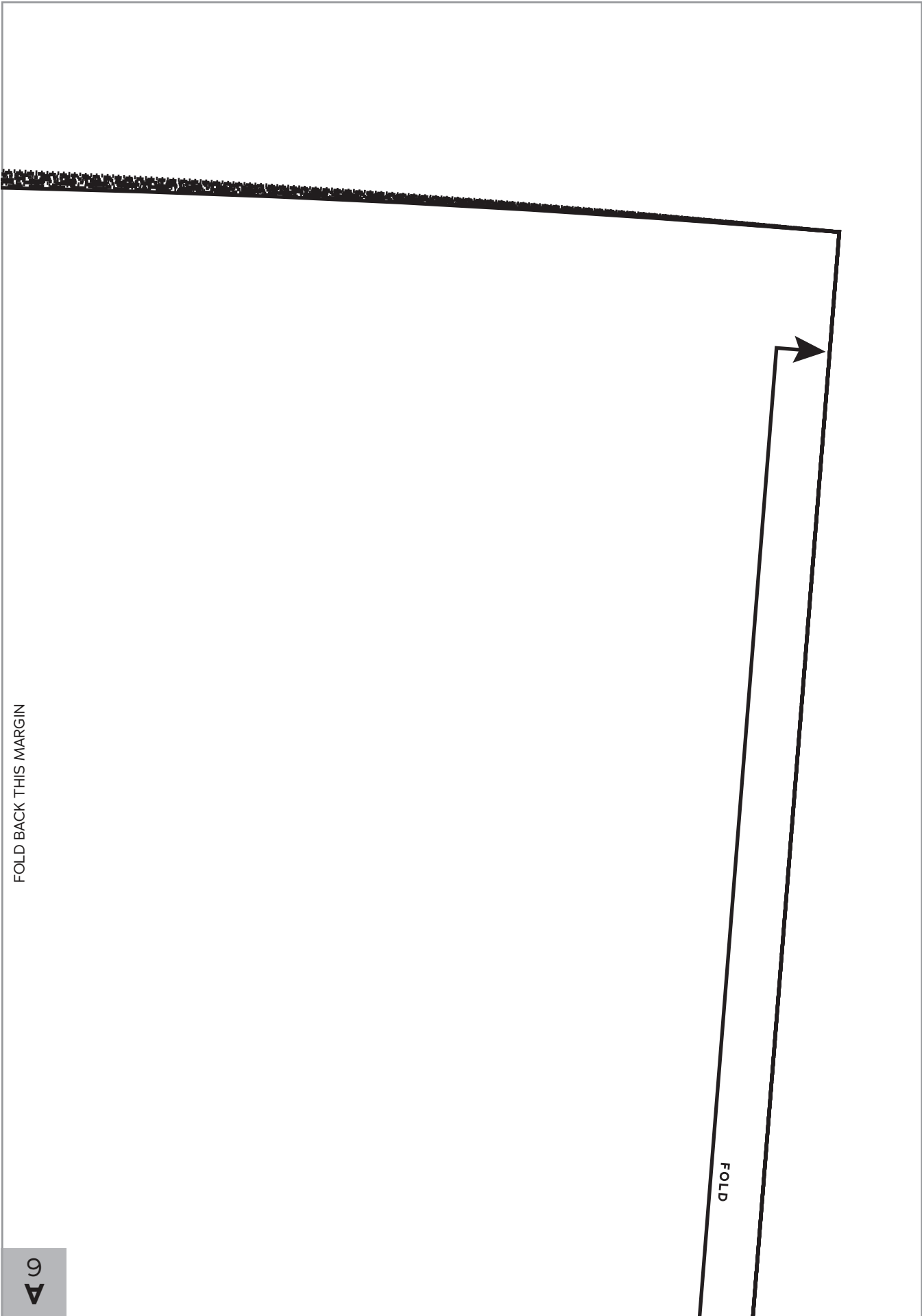

FOLD BACK THIS MARGIN

FOLD

9  
▲

FOLD BACK THIS MARGIN

B  
3

C  
3

**B**  
3

FOLD BACK THIS MARGIN

**B**  
4

FOLD BACK THIS MARGIN



**C**  
3

**D**  
4

2  
4  
6  
8  
10  
12  
14  
16  
18  
20

FOLD BACK THIS MARGIN

**B**  
4

**C**  
4

FOLD BACK THIS MARGIN

GRAINLINE



# CAROUSEL DRESS

SIZES 2-20

## 4

Dress  
Side  
Back

Cut 2 fabric

**D**  
4

**E**  
4

2

4

6

8

10

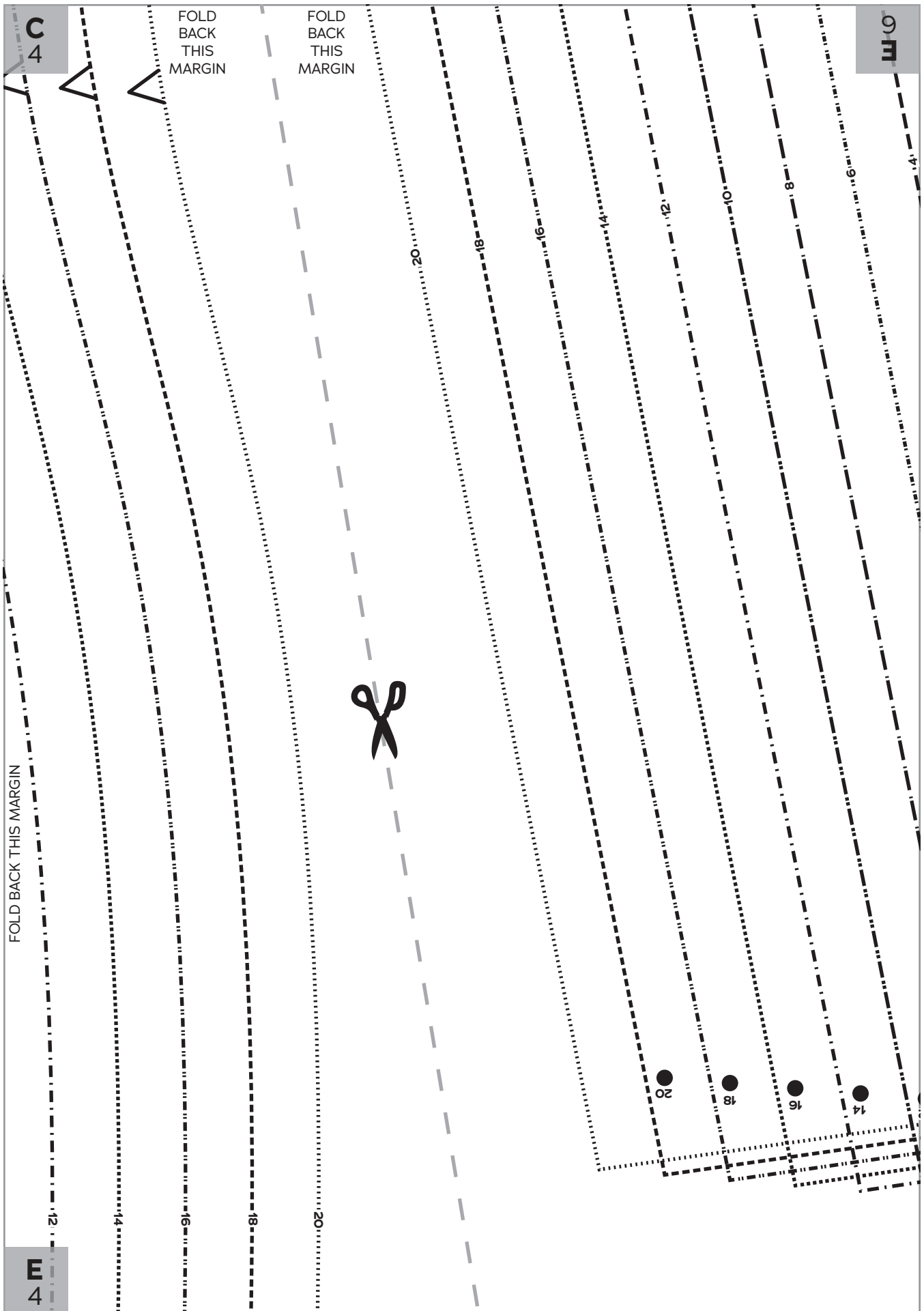



FOLD BACK THIS MARGIN

9

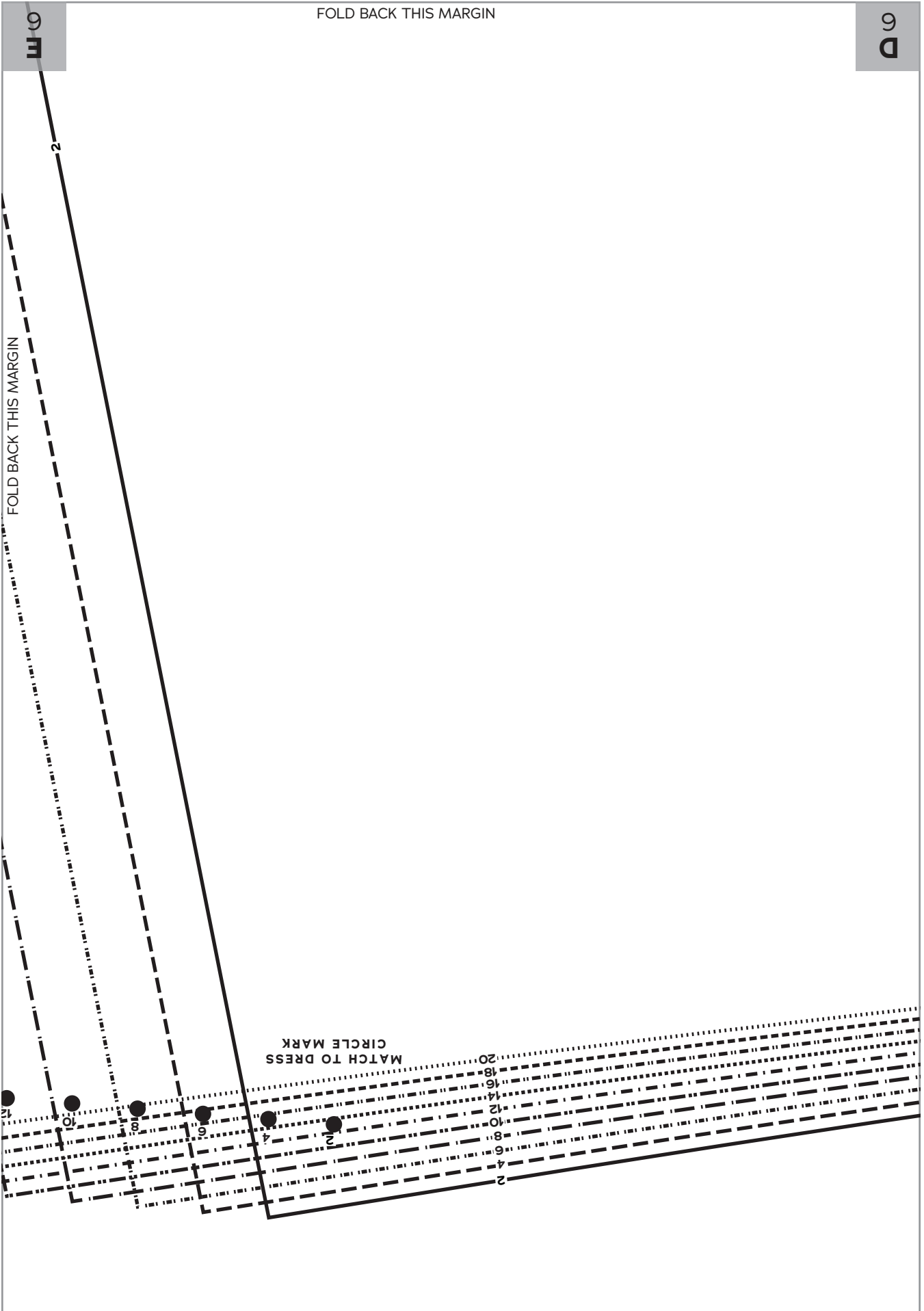



FOLD BACK THIS MARGIN



FOLD BACK THIS MARGIN

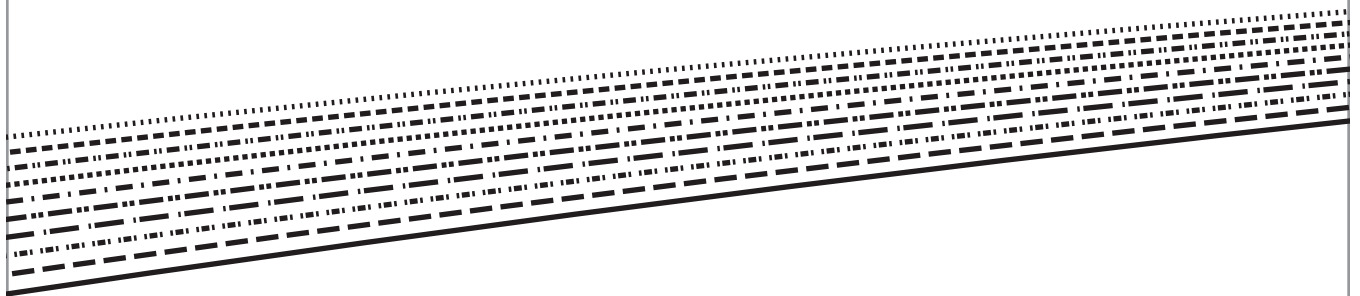

FOLD BACK THIS MARGIN



FOLD BACK THIS MARGIN

GATHER BETWEEN CIRCLES

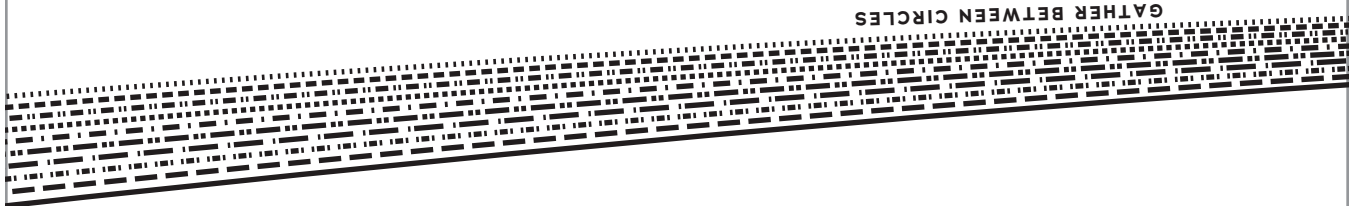

9  
B

FOLD BACK THIS MARGIN

9  
A

FOLD BACK THIS MARGIN



9



FOLD BACK THIS MARGIN

FOLD BACK THIS MARGIN



FOLD BACK THIS MARGIN



**ZIPPER**

**C**  
3

2  
4  
6  
8  
10

**FLOUNCE DRESS CUTTING LINE**

**D**  
3

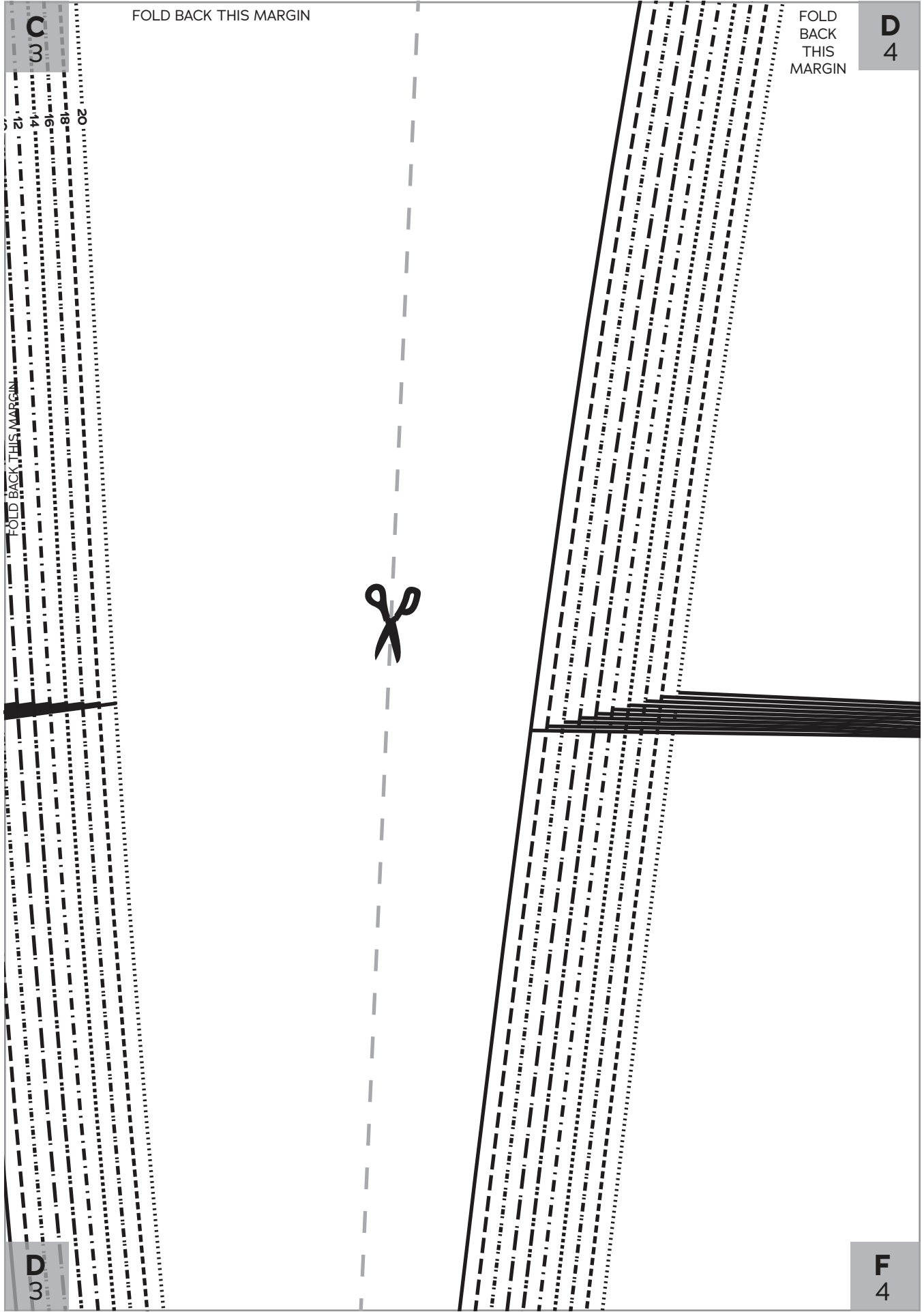

FOLD BACK THIS MARGIN

FOLD BACK THIS MARGIN

D  
4

FOLD BACK THIS MARGIN



20  
18  
16  
14  
12

F  
4

**D**  
4

FOLD BACK THIS MARGIN

**E**  
4

FOLD BACK THIS MARGIN



2 ● 4 ●  
MATCH TO  
FLOUNCE  
CIRCLE MARK

6 ● 8 ● 10 ● 12 ●

FLOUNCE DRESS CUTTING LINE

**F**  
4

**G**  
4



**E**  
4

FOLD BACK  
THIS MARGIN

FOLD BACK THIS MARGIN

14

16

18

20



**G**  
4

**U**  
M

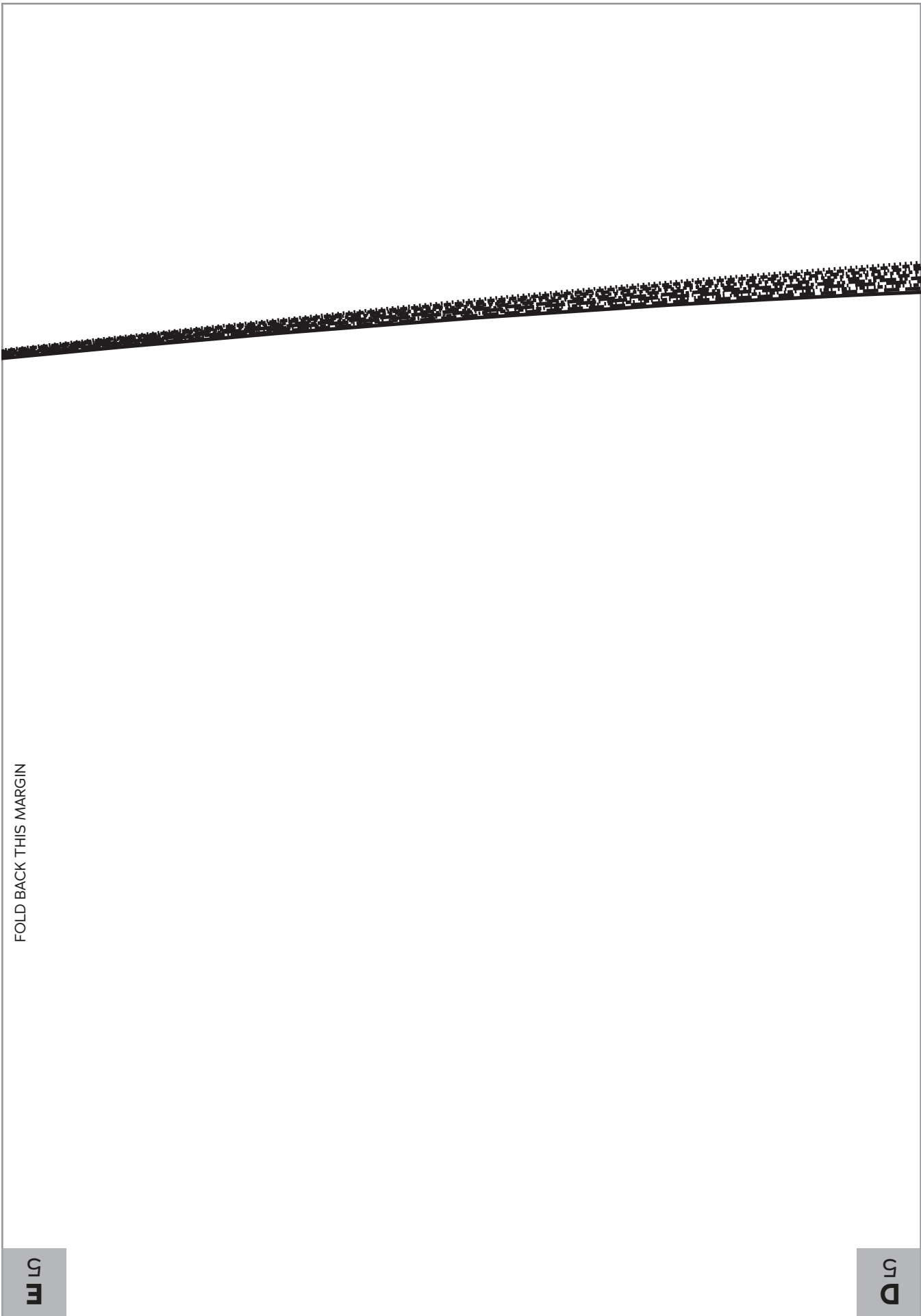

FOLD BACK THIS MARGIN

G  
D

G  
D

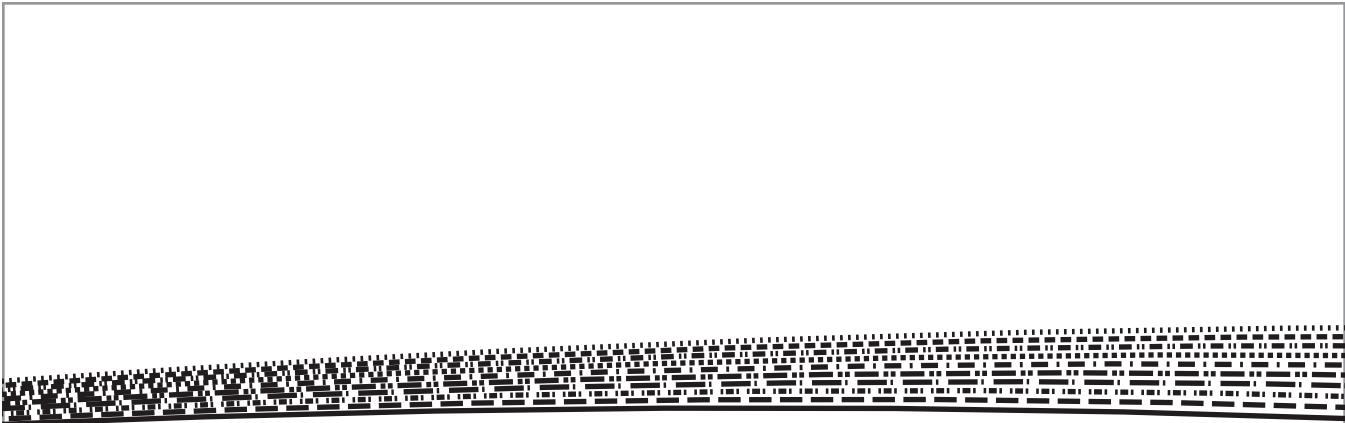

FOLD BACK THIS MARGIN

**5**  
 Flounce  
 Front  
 Cut 1 fabric on fold,  
 2 tulle on fold  
 (tulle is optional)  
**CAROUSEL**  
**DRESS**  
 SIZES 2-20



5 D

5 C

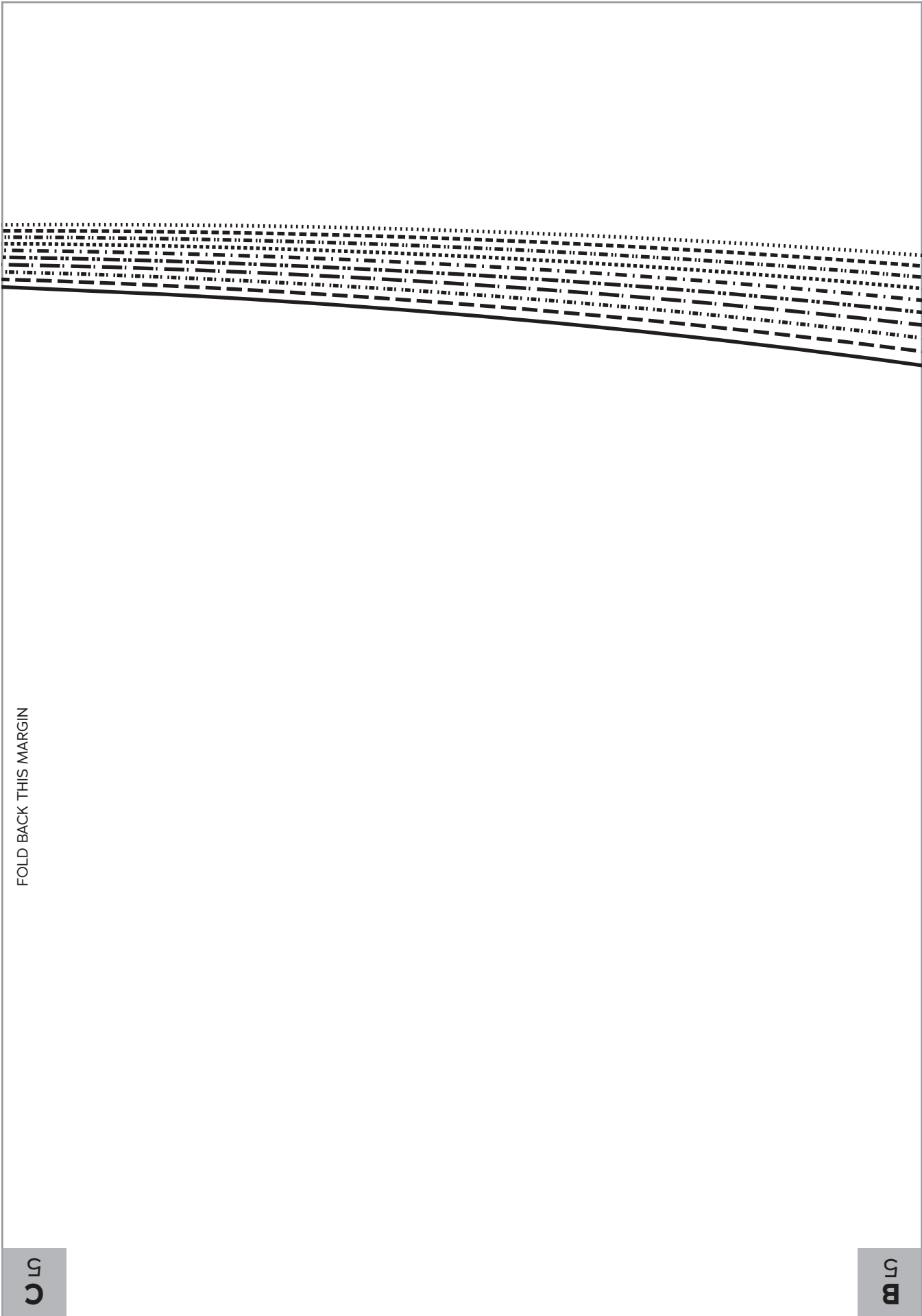

FOLD BACK THIS MARGIN



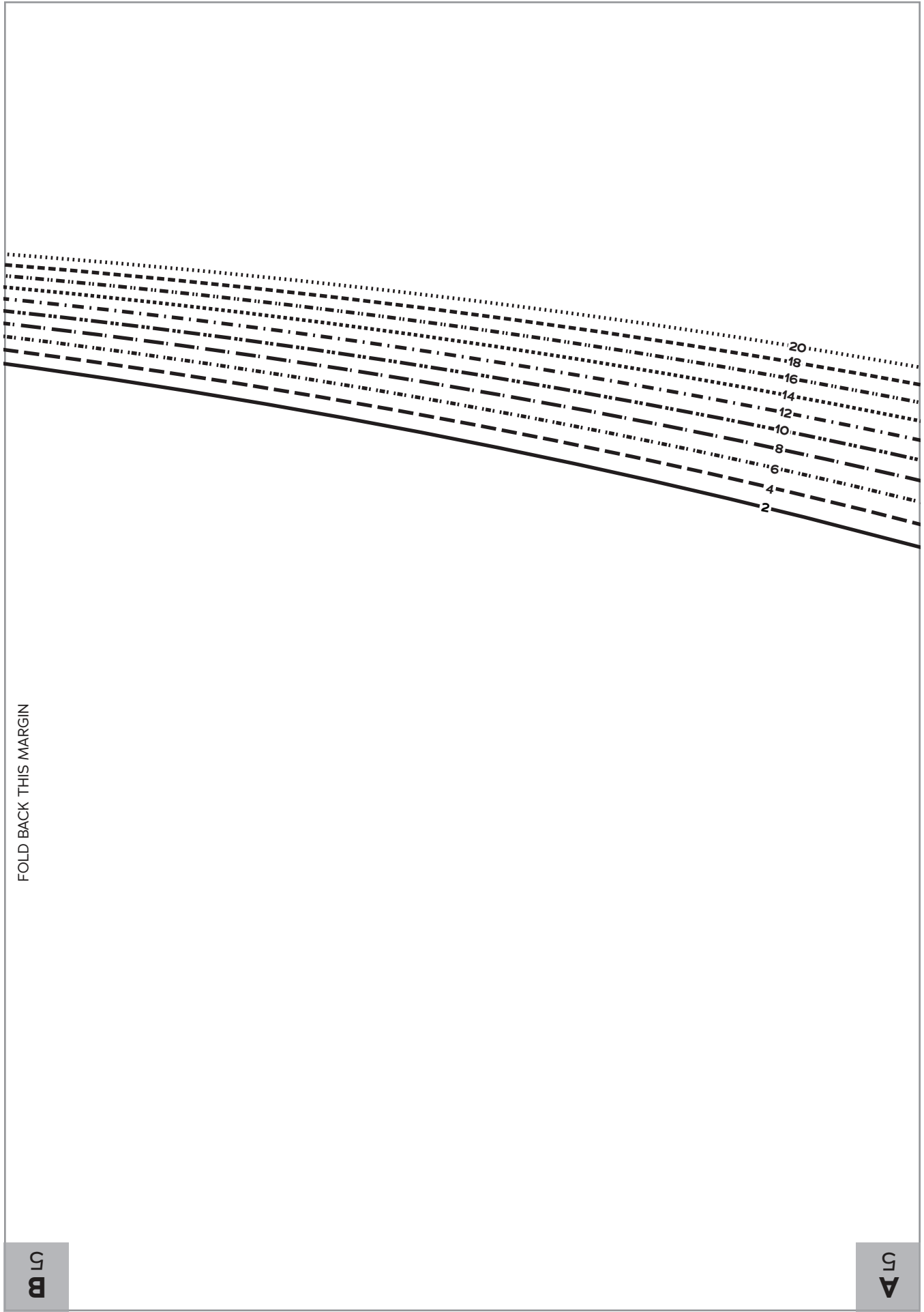

FOLD BACK THIS MARGIN

20  
18  
16  
14  
12  
10  
8  
6  
4  
2



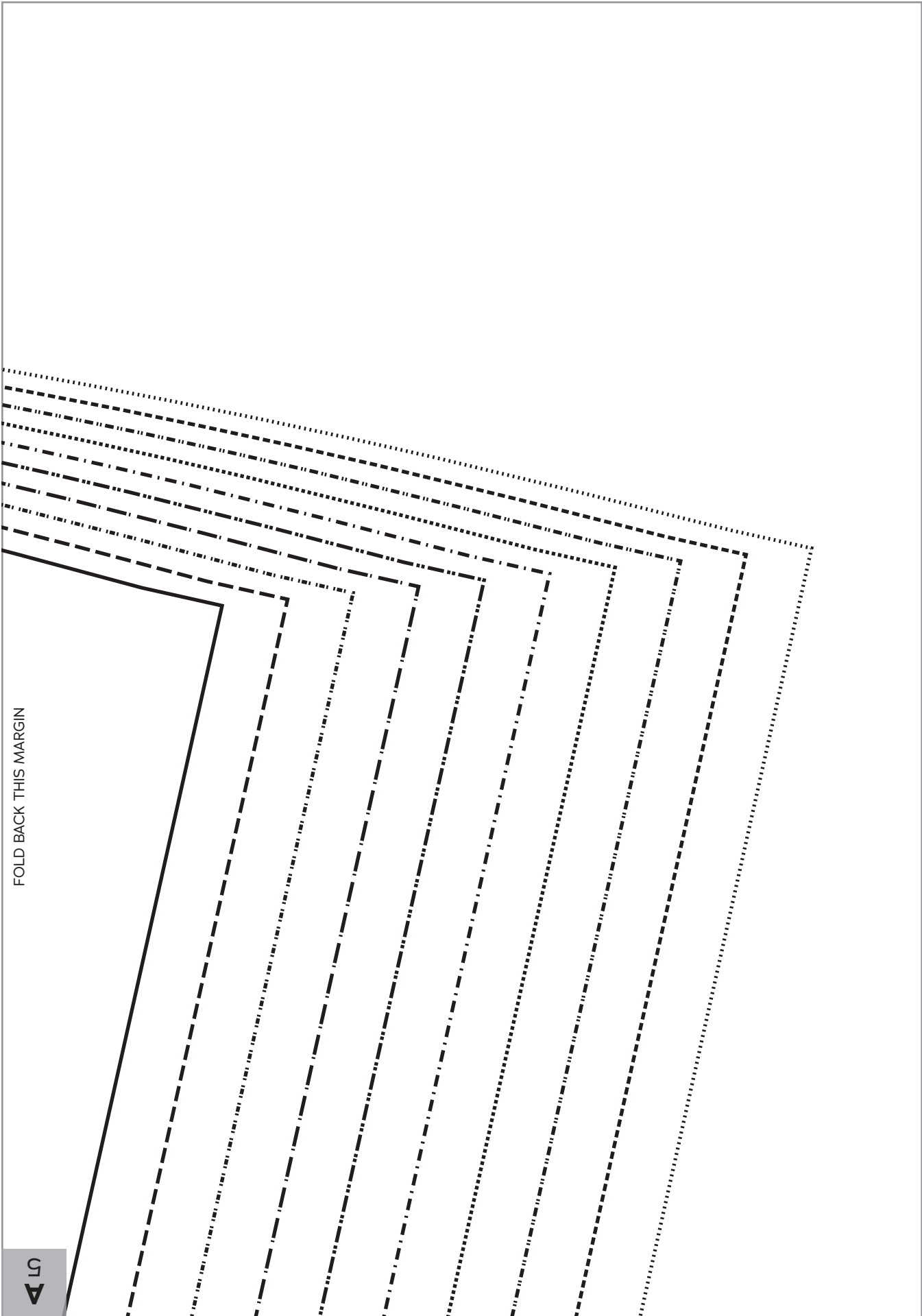

FOLD BACK THIS MARGIN

LC  
▽

FOLD BACK THIS MARGIN

D  
3

D  
3

FOLD BACK THIS  
MARGIN

FOLD BACK THIS MARGIN

F  
4

FOLD BACK THIS MARGIN

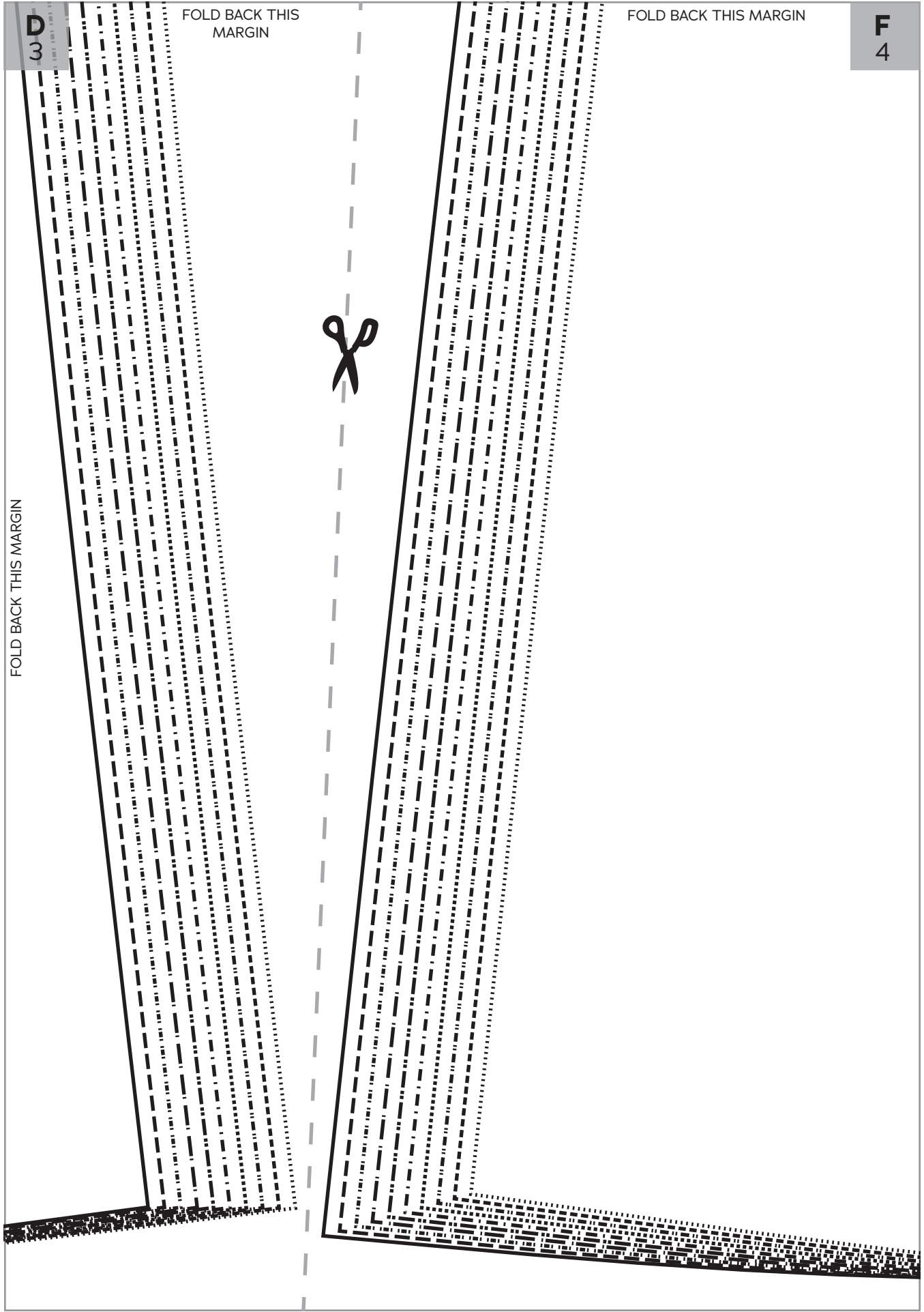



**F**  
4

FOLD BACK THIS MARGIN

**G**  
4

FOLD BACK THIS MARGIN

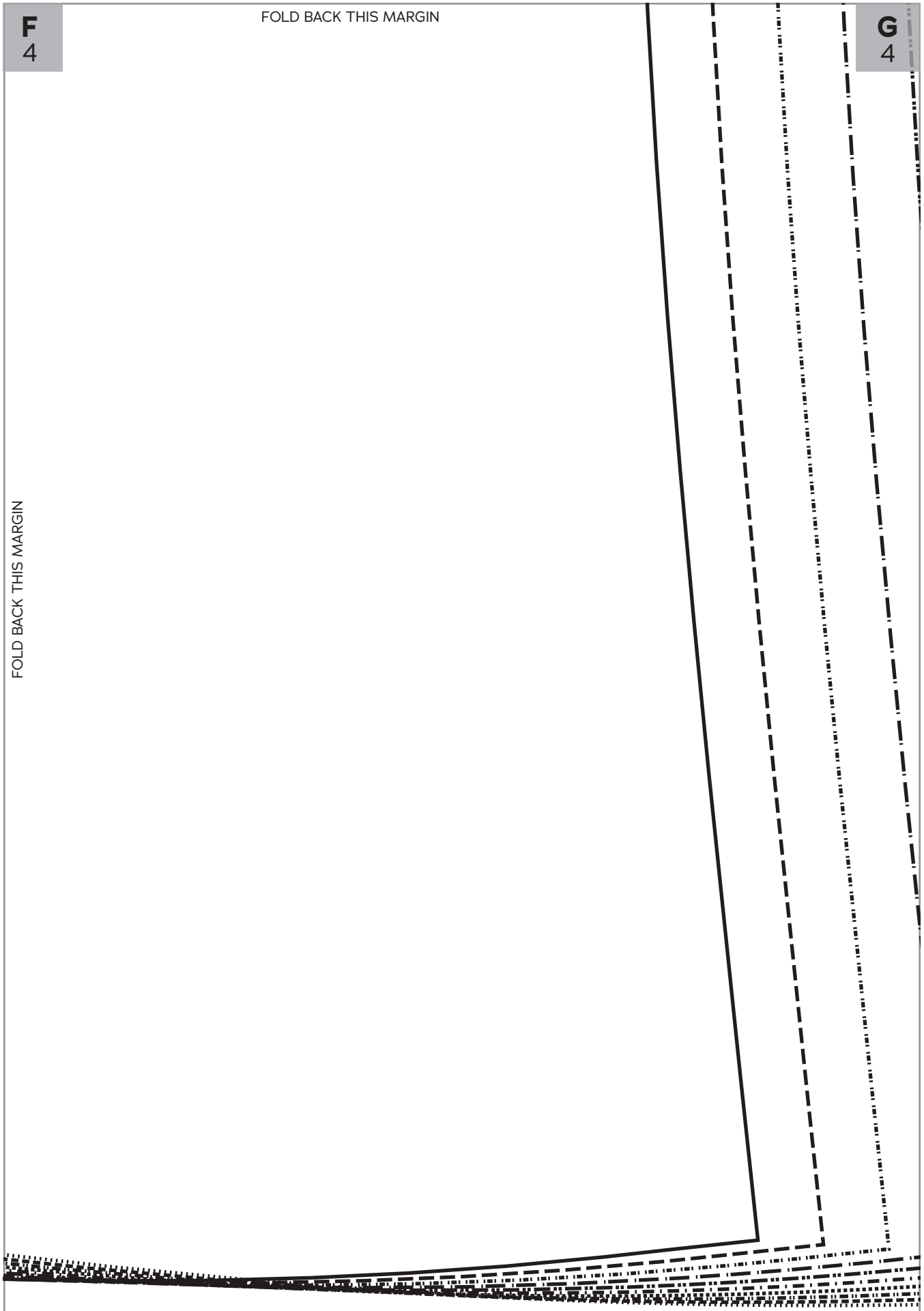

G  
4

FOLD BACK  
THIS  
MARGIN

FOLD BACK THIS MARGIN

STM

FOLD BACK THIS MARGIN

FOLD



ST  
D

FOLD BACK THIS MARGIN

ST  
D

FOLD BACK THIS MARGIN





FOLD BACK THIS MARGIN



FOLD BACK THIS MARGIN





FOLD BACK THIS MARGIN



FOLD BACK THIS MARGIN

GATHER BETWEEN CIRCLES

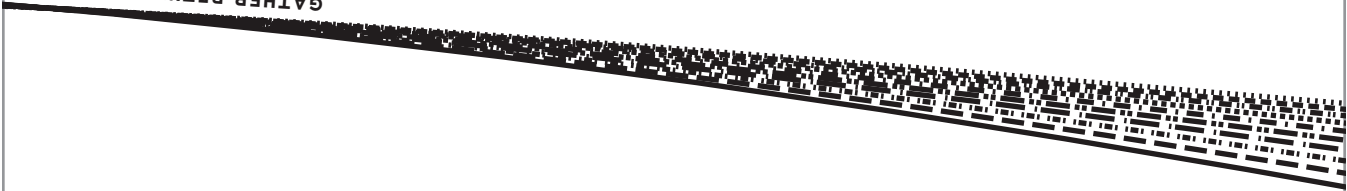

5  
B

FOLD BACK THIS MARGIN

5  
A

FOLD BACK THIS MARGIN

