

# Aurora

## BODICE

Sizes 18-34  
with cup sizes A-H

5/8 inch (in) (1.5 cm) seam allowances are included on all pattern pieces.

*Society*  
of CHARM

SIZE 18-34  
PATTERN  
SIZE KEY

- 18 - - - - -
- 20 ·····
- 22 - - - - -
- 24 - - - - -
- 26 ·····
- 28 - - - - -
- 30 - - - - -
- 32 ·····
- 34 - - - - -

SYMBOL KEY

grainline arrow



match point/  
placement mark



1 in  
test  
square

2 cm  
test  
square

© 2023 Charm Patterns  
by Gertie. Distribution  
and Commercial Use  
Prohibited.

FOLD BACK THIS MARGIN

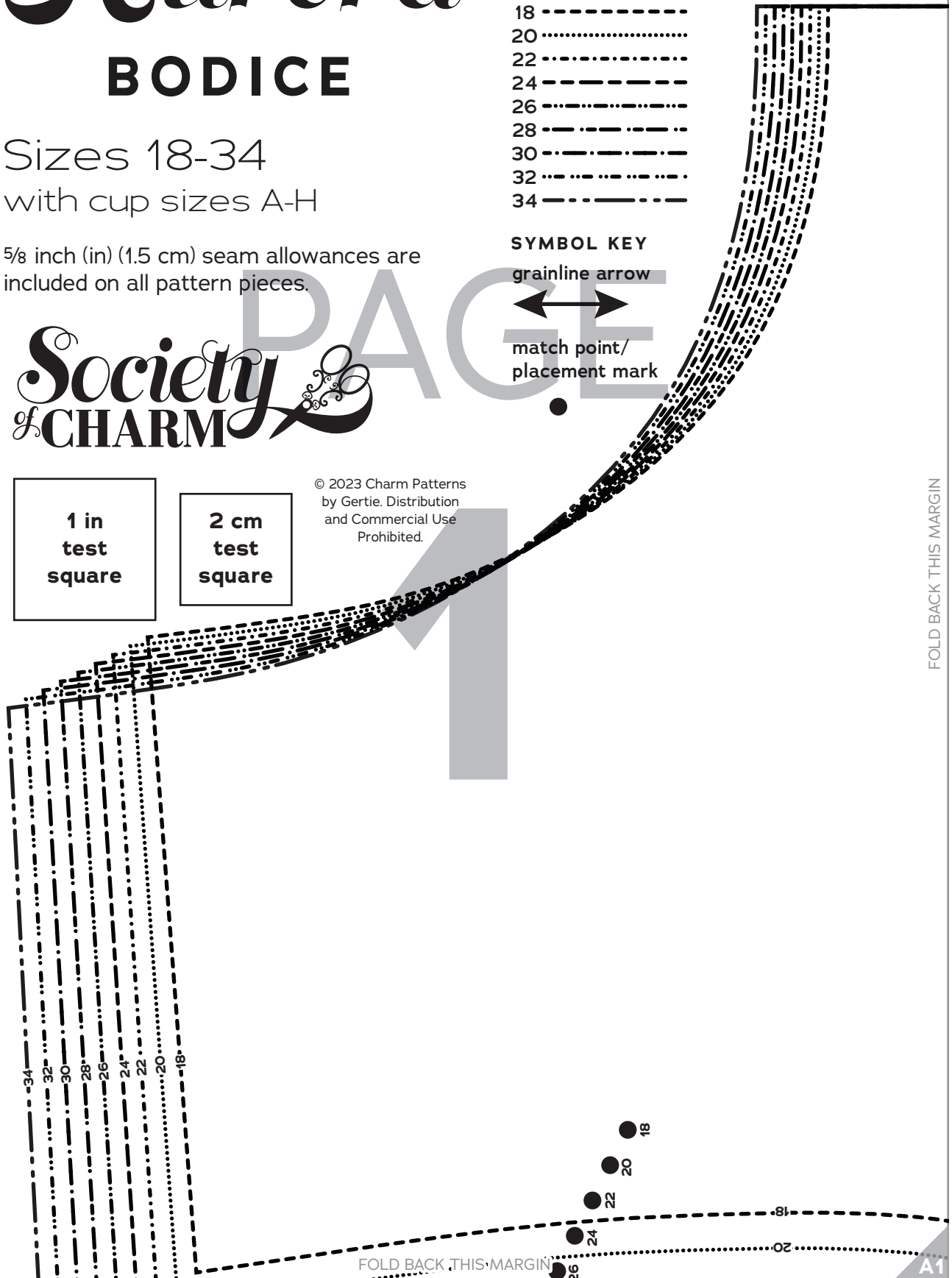

FOLD BACK THIS MARGIN

A1

Society  
of  
CHARM

*Aurora*

**BODICE**

SIZES 18-34

1

Bodice Front,  
A/B Cup

Cut 1 fabric on fold,  
1 lining on fold

FOLD

PAGE

FOLD BACK THIS MARGIN

18  
20  
22  
24  
26  
28  
30  
32  
34

A1

FOLD BACK THIS MARGIN

A2

PAGE

3

FOLD BACK THIS MARGIN

A2

FOLD BACK THIS MARGIN

A3

PAGE

Society  
of CHARM  
**Aurora**  
BODICE  
SIZES 18-34

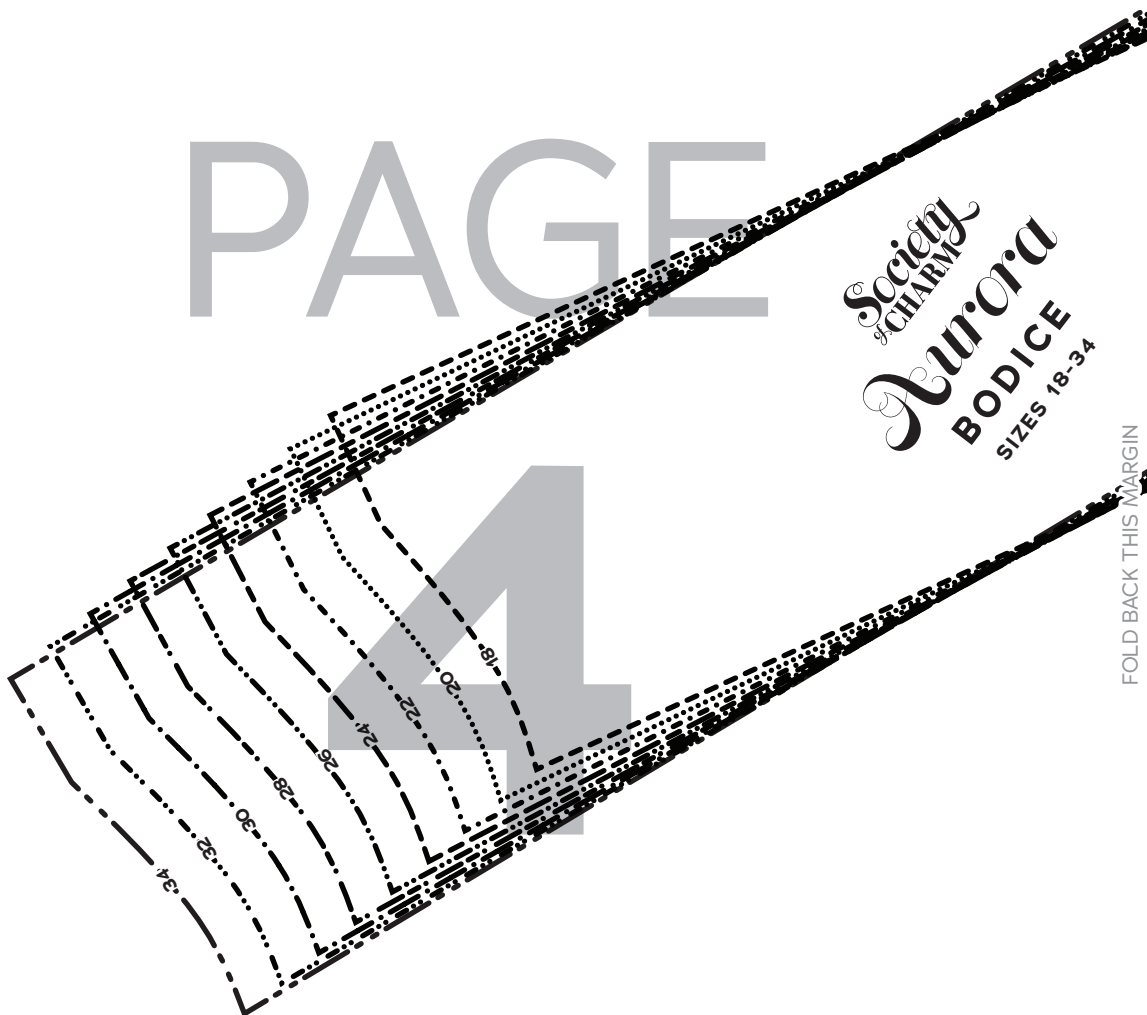

FOLD BACK THIS MARGIN

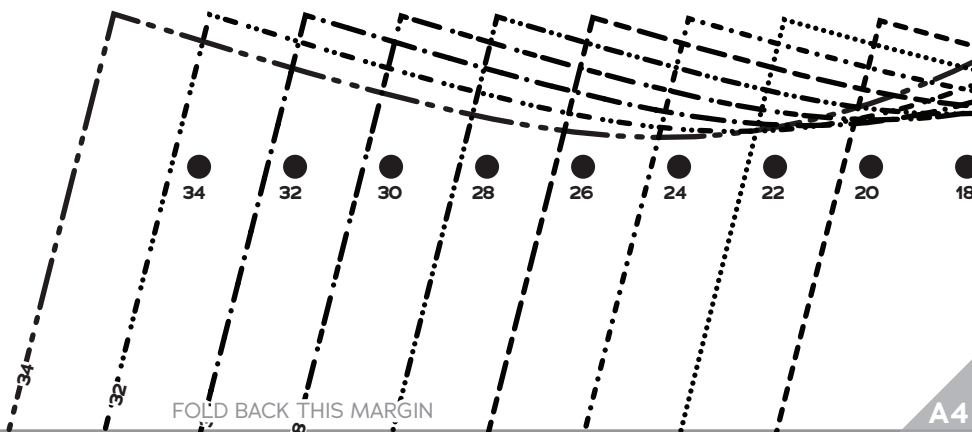

FOLD BACK THIS MARGIN

A3

A4

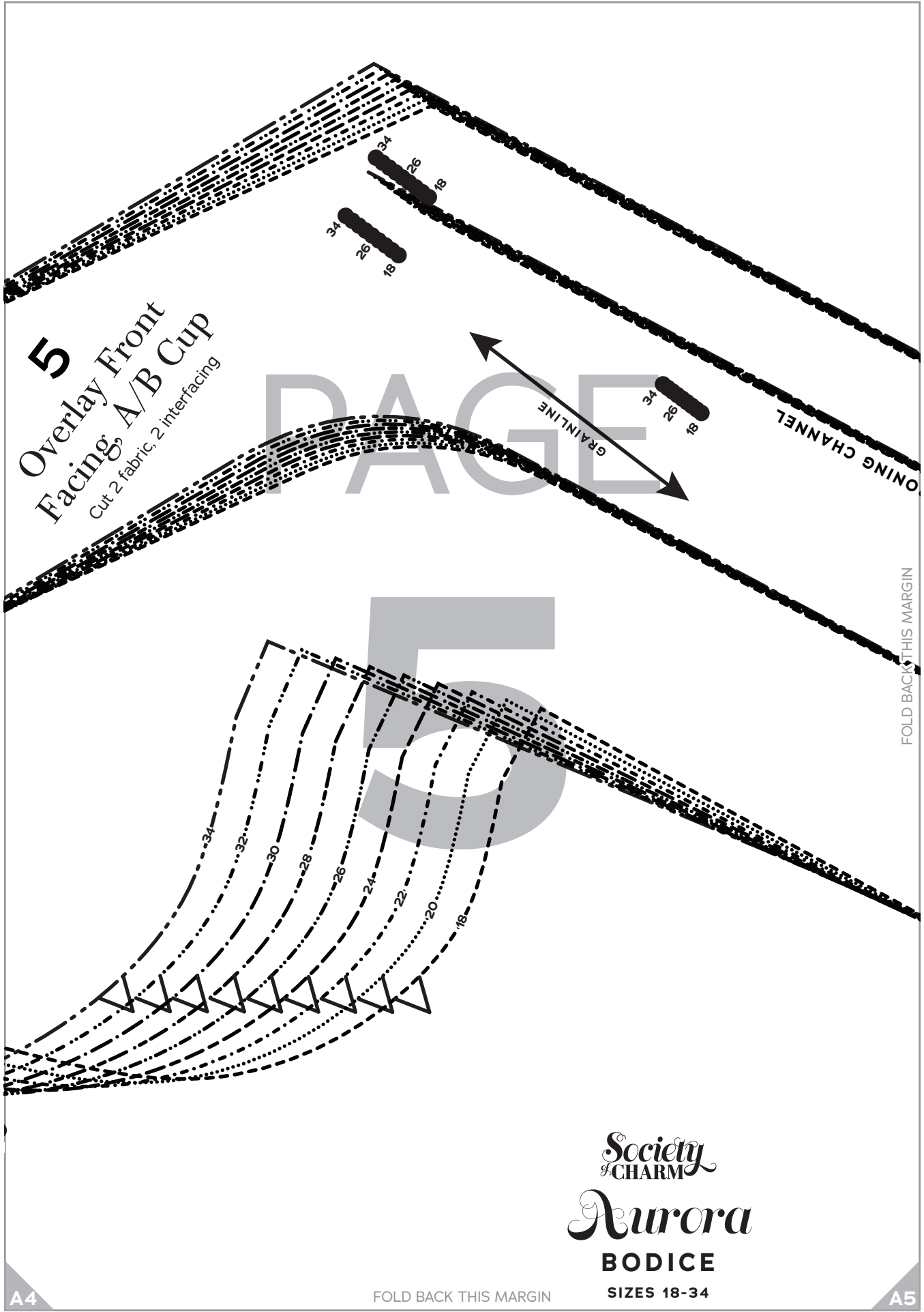

**5**  
**Overlay Front Facing A/B Cup**  
Cut 2 fabric, 2 interfacing

SEAMING CHANNEL

GRAINLINE

FOLD BACK THIS MARGIN

34  
32  
30  
28  
26  
24  
22  
20  
18

*Society of CHARM*  
**Aurora**  
**BODICE**  
**SIZES 18-34**

A4

FOLD BACK THIS MARGIN

A5

PAGE

6

FOLD BACK THIS MARGIN

34  
18

34  
18

34  
26  
18

FOLD BACK THIS MARGIN

A5

A6

PAGE

7



FOLD

FOLD BACK THIS MARGIN

18 20 22 24 26 28

A6

FOLD BACK THIS MARGIN

A7

# PAGE 8

FOLD BACK THIS MARGIN

30  
32  
34

18  
20  
22  
24  
26  
28  
30  
32

A7

FOLD BACK THIS MARGIN

A8



PAGE  
9

FOLD BACK THIS MARGIN

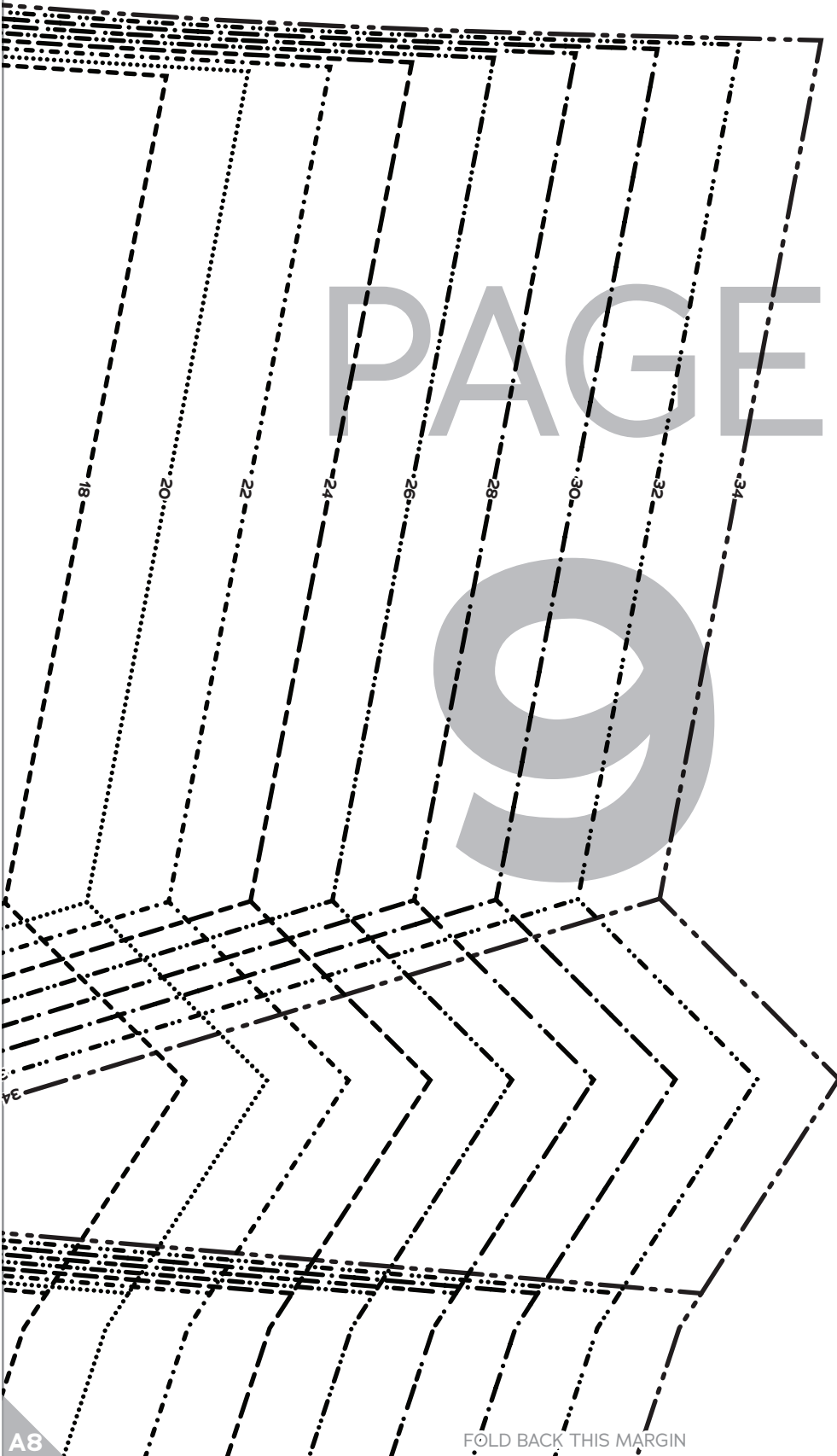

A8

FOLD BACK THIS MARGIN

A9

PAGE

Society  
of CHARM  
**Aurora**  
BODICE  
SIZES 18-34

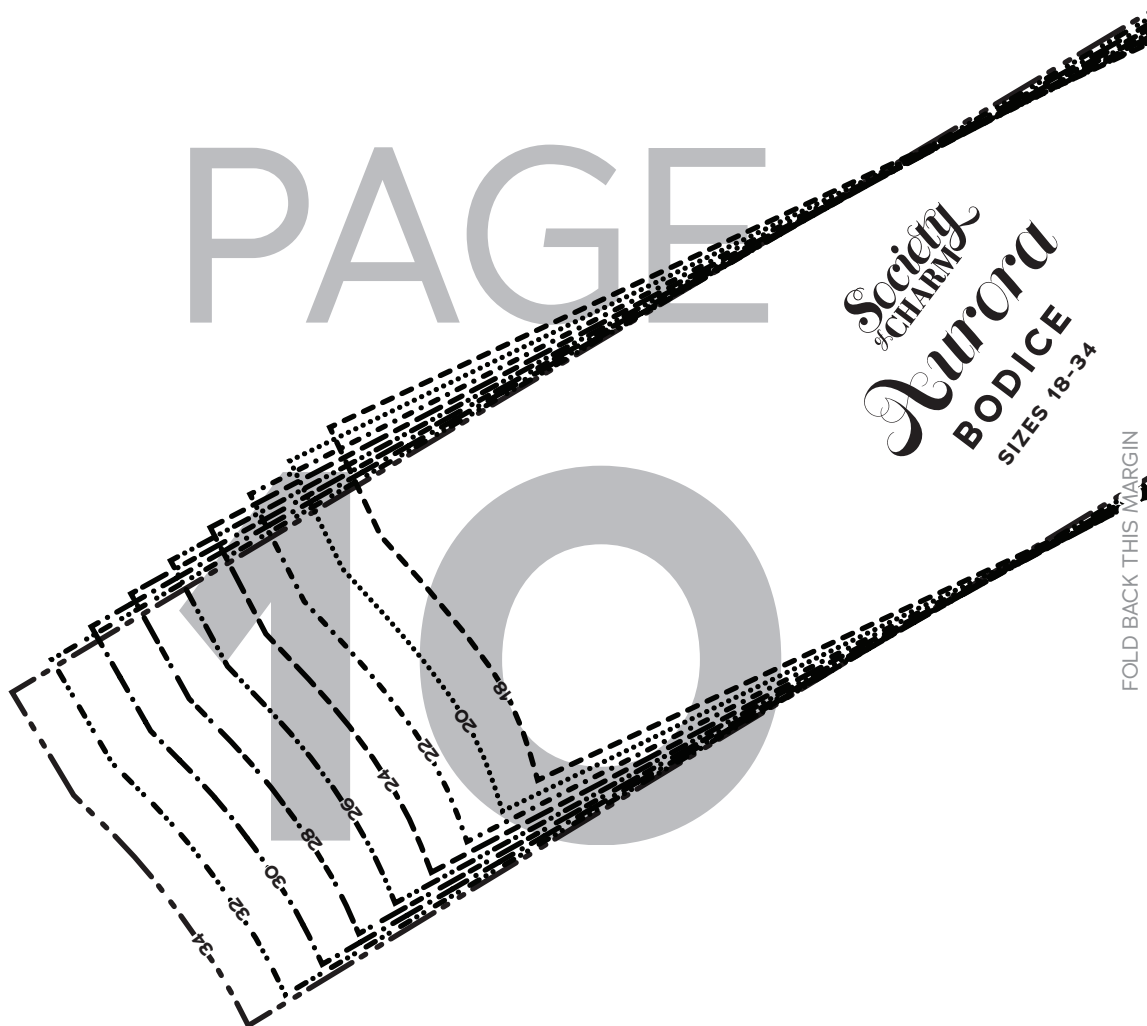

FOLD BACK THIS MARGIN

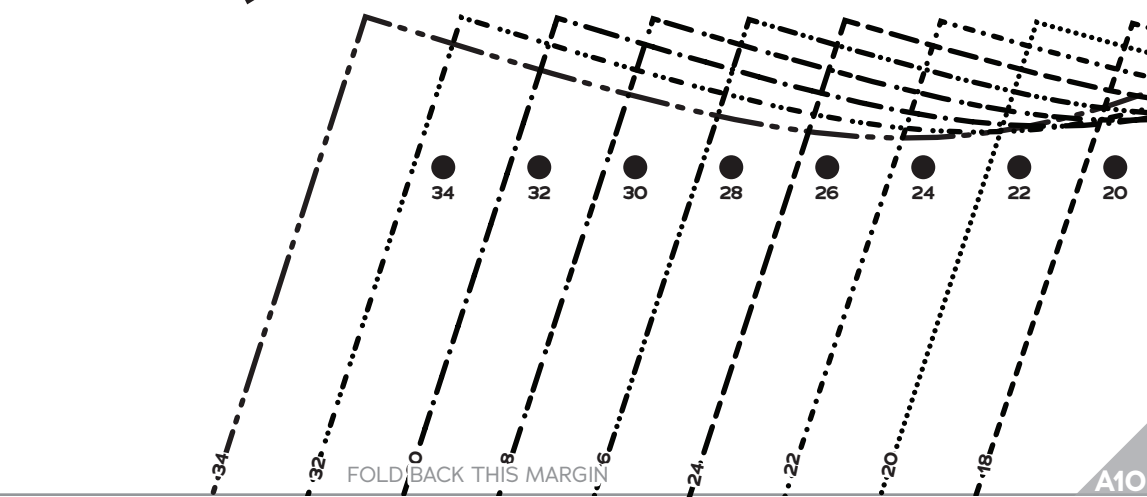

FOLD BACK THIS MARGIN

A9

A10

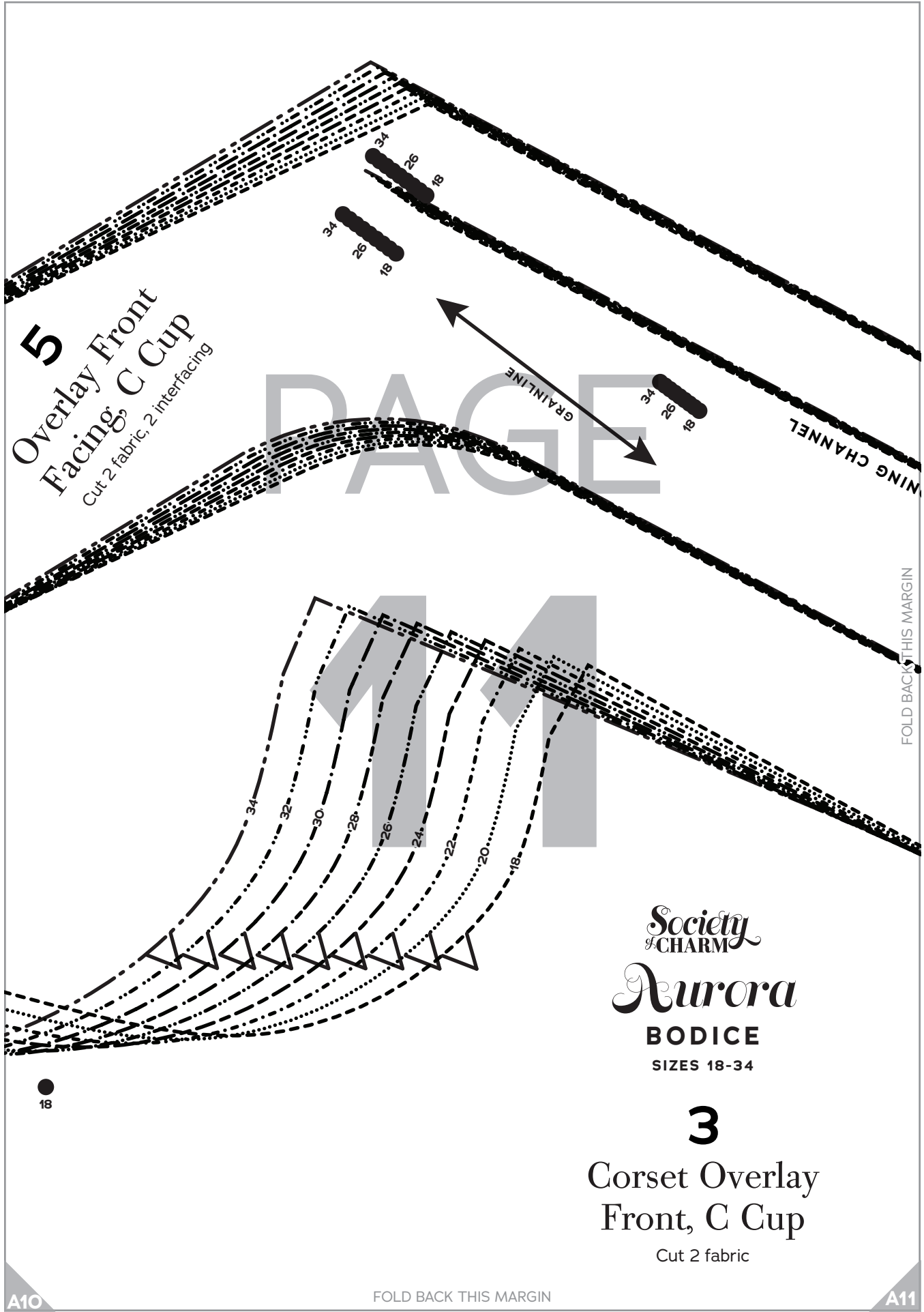

**5**  
Overlay Front  
Facing, C Cup  
Cut 2 fabric, 2 interfacing

ING CHANNEL

FOLD BACK THIS MARGIN

GRAINLINE

*Society*  
of CHARM  
*Aurora*  
**BODICE**  
SIZES 18-34

**3**  
Corset Overlay  
Front, C Cup  
Cut 2 fabric

●  
18

A10

FOLD BACK THIS MARGIN

A11

PAGE

12

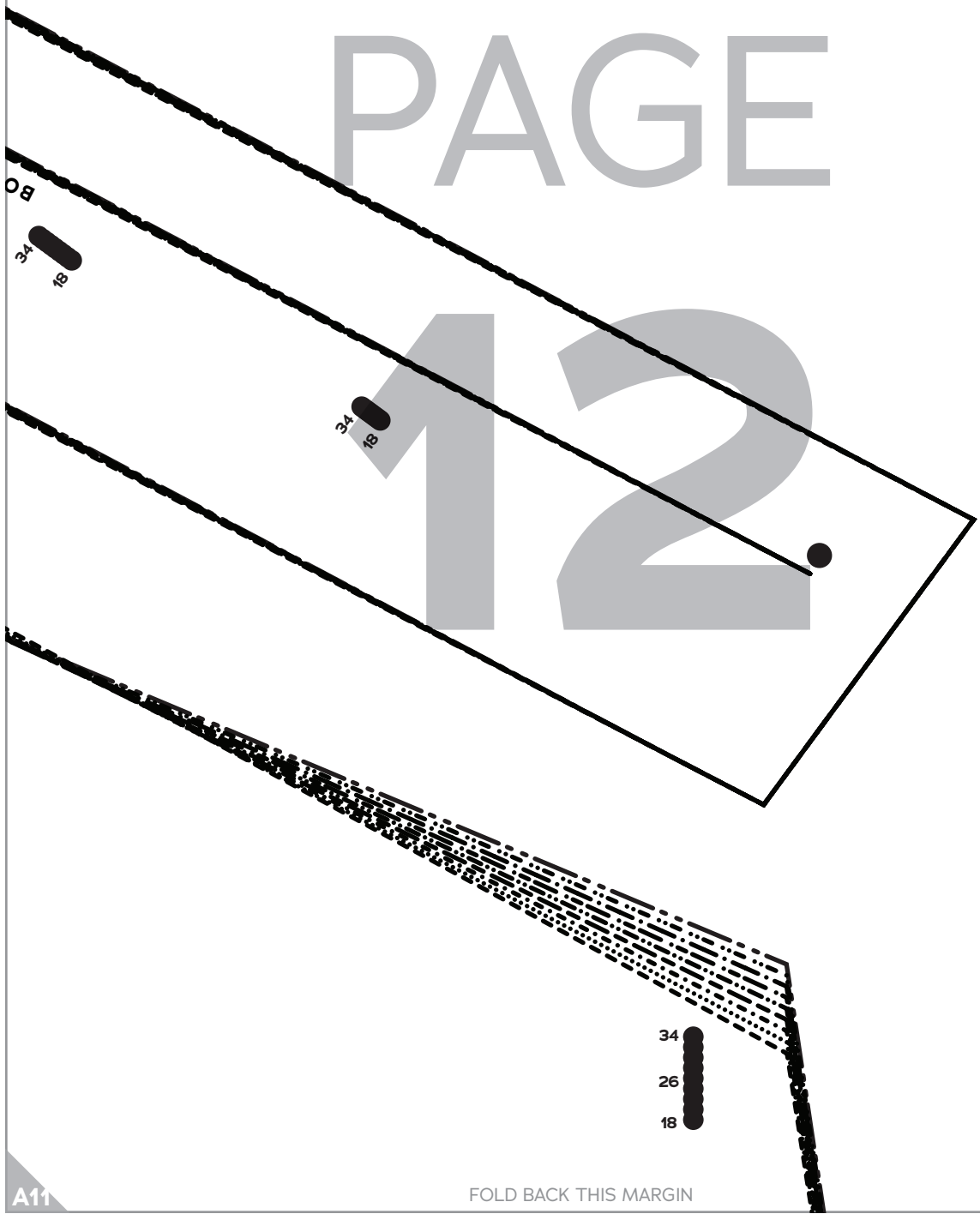

OB  
34  
18

34  
18

34  
26  
18

A11

FOLD BACK THIS MARGIN

A1

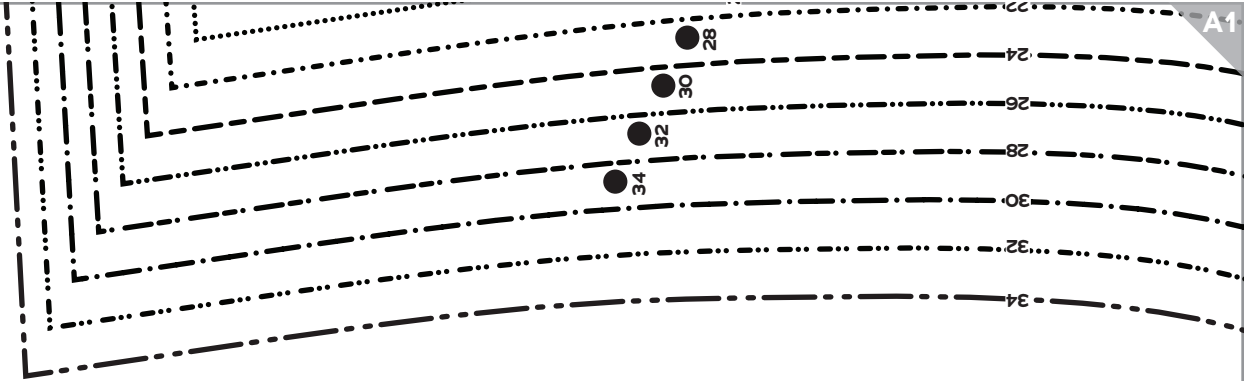

PAGE

13

FOLD BACK THIS MARGIN

FOLD BACK THIS MARGIN

B1

A1

A2

PAGE

14

● 18

● 20

● 22

● 24

● 26

● 28

● 30

● 32

● 34

34  
30  
26  
22  
18

FOLD BACK THIS MARGIN

B1

FOLD BACK THIS MARGIN

B2

A2

A3

PAGE

15

FOLD BACK THIS MARGIN

B2

FOLD BACK THIS MARGIN

B3

A3

A4

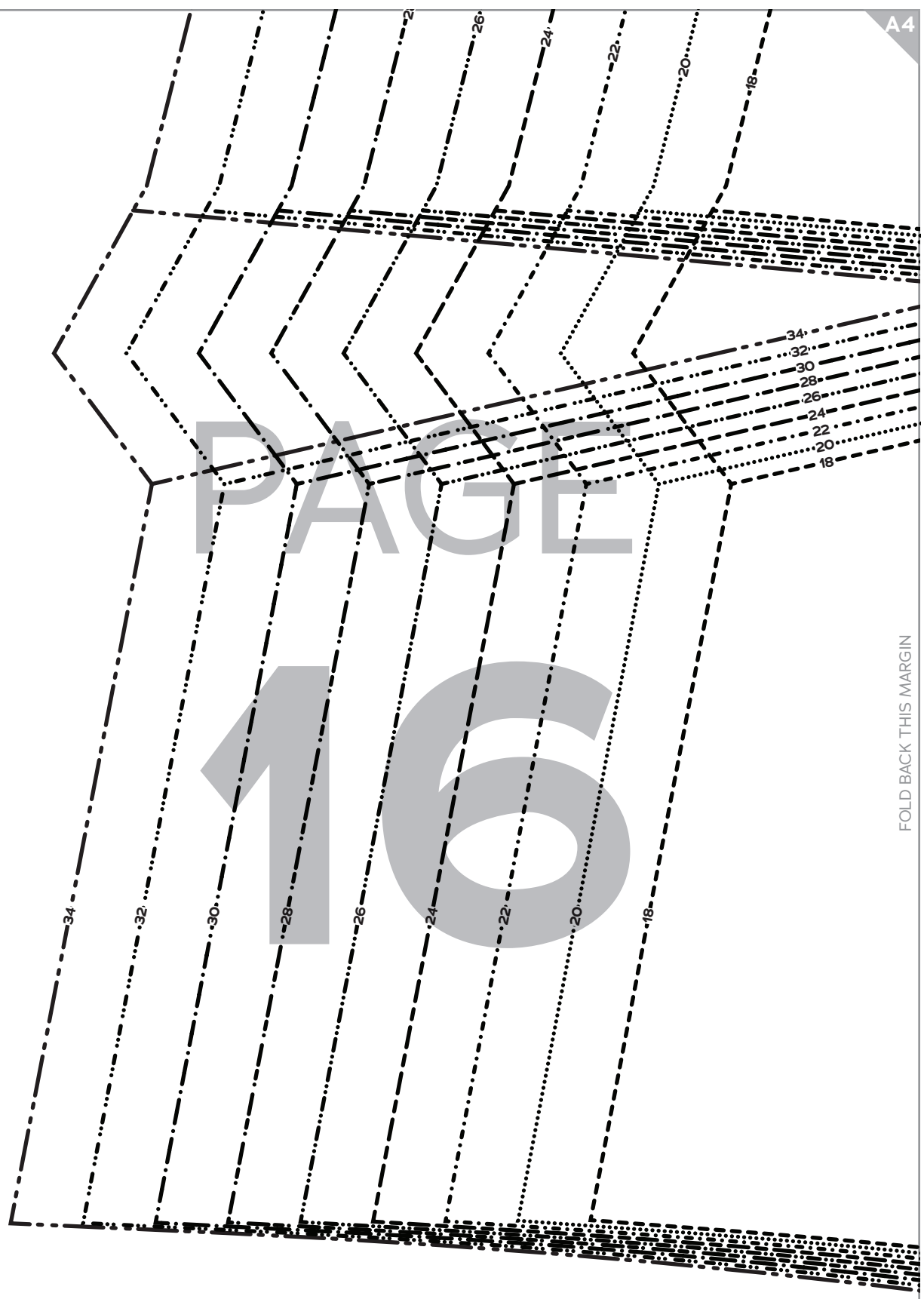

PAGE  
16

FOLD BACK THIS MARGIN

FOLD BACK THIS MARGIN

B3

B4



# 3

## Corset Overlay Front, A/B Cup

Cut 2 fabric

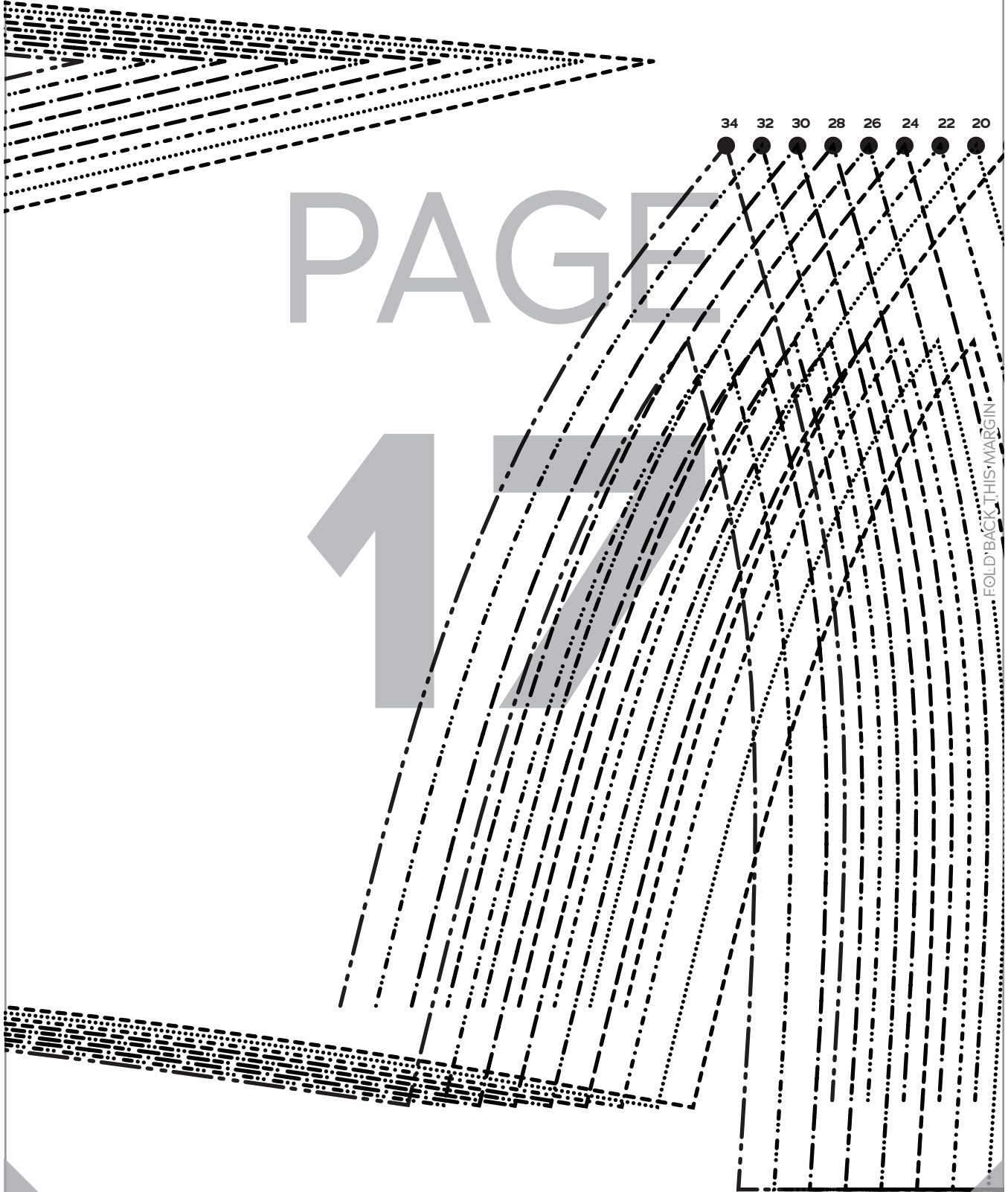

PAGE

17

FOLD BACK THIS MARGIN

FOLD BACK THIS MARGIN

A5

A6

18

PAGE

18

GRAIN LINE

FOLD BACK THIS MARGIN

FOLD BACK THIS MARGIN

B5

B6

A6

A7

Bodice Front,  
C Cup  
Cut 1 fabric on fold,  
1 lining on fold



SIZES 18-34

**BODICE**

*Aurora*

*Society  
of CHARM*

PAGE

19

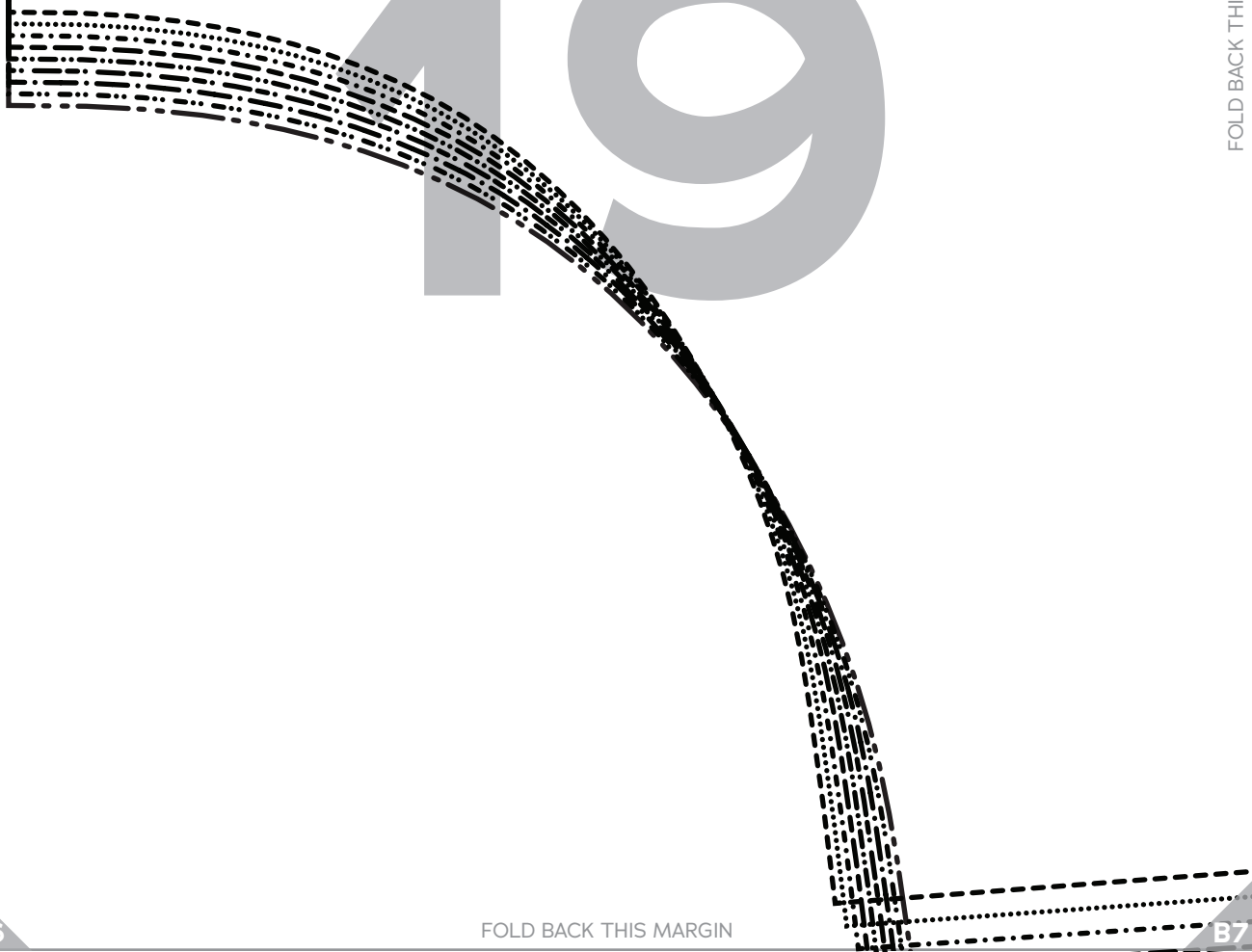

FOLD BACK THIS MARGIN

FOLD BACK THIS MARGIN

B6

B7

A7

A8

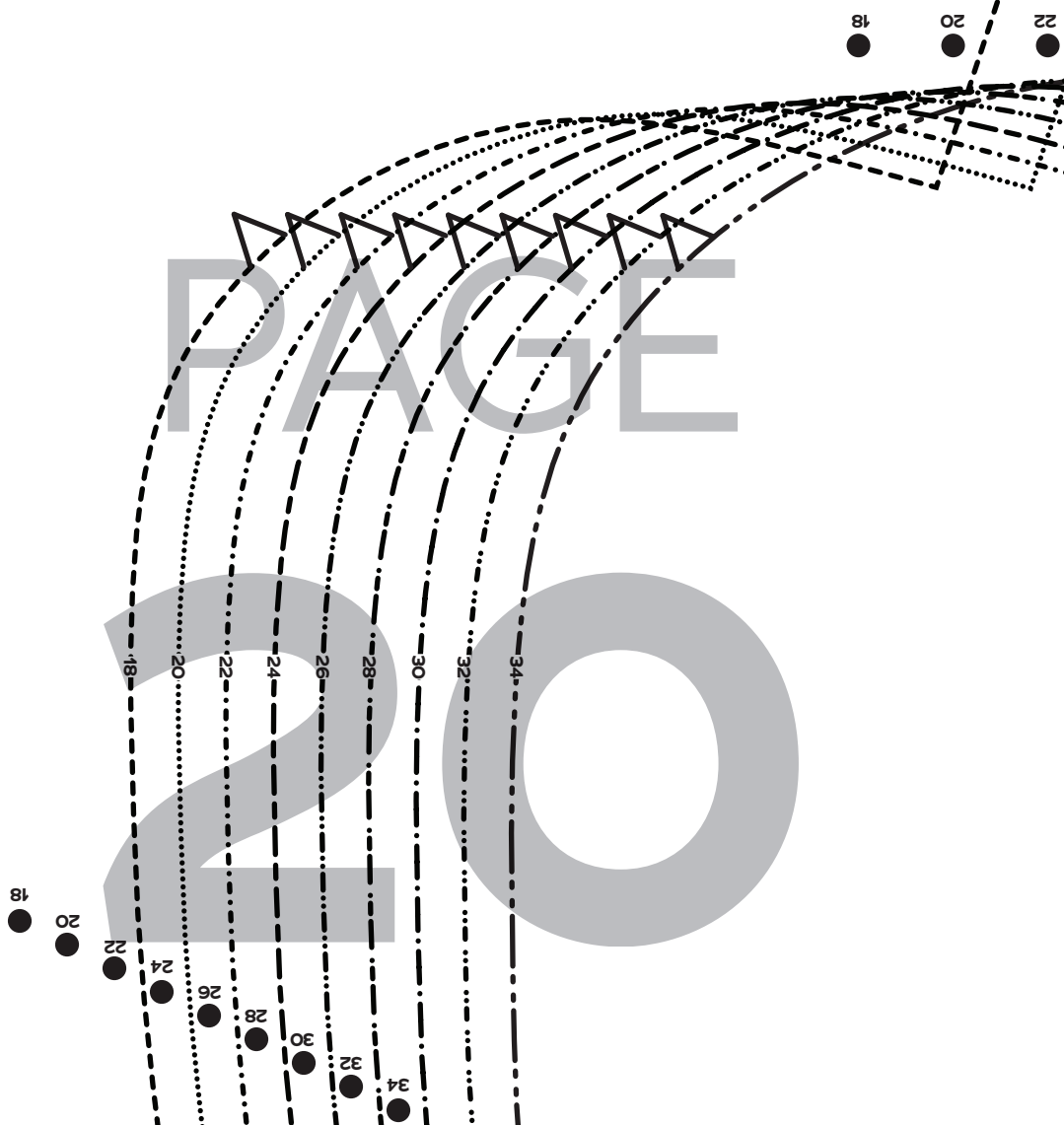

PAGE

20

FOLD BACK THIS MARGIN

B7

B8

FOLD BACK THIS MARGIN

A8

A9



# PAGE

# 21

FOLD BACK THIS MARGIN

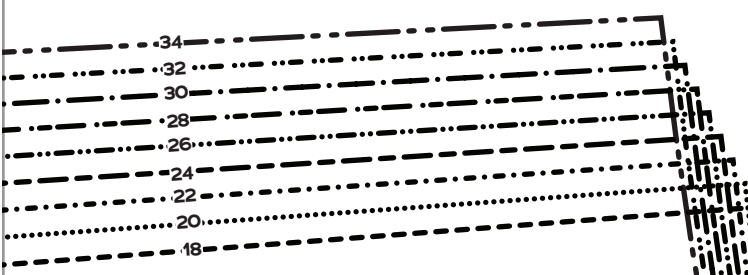

B8

B9

FOLD BACK THIS MARGIN

A9

A10

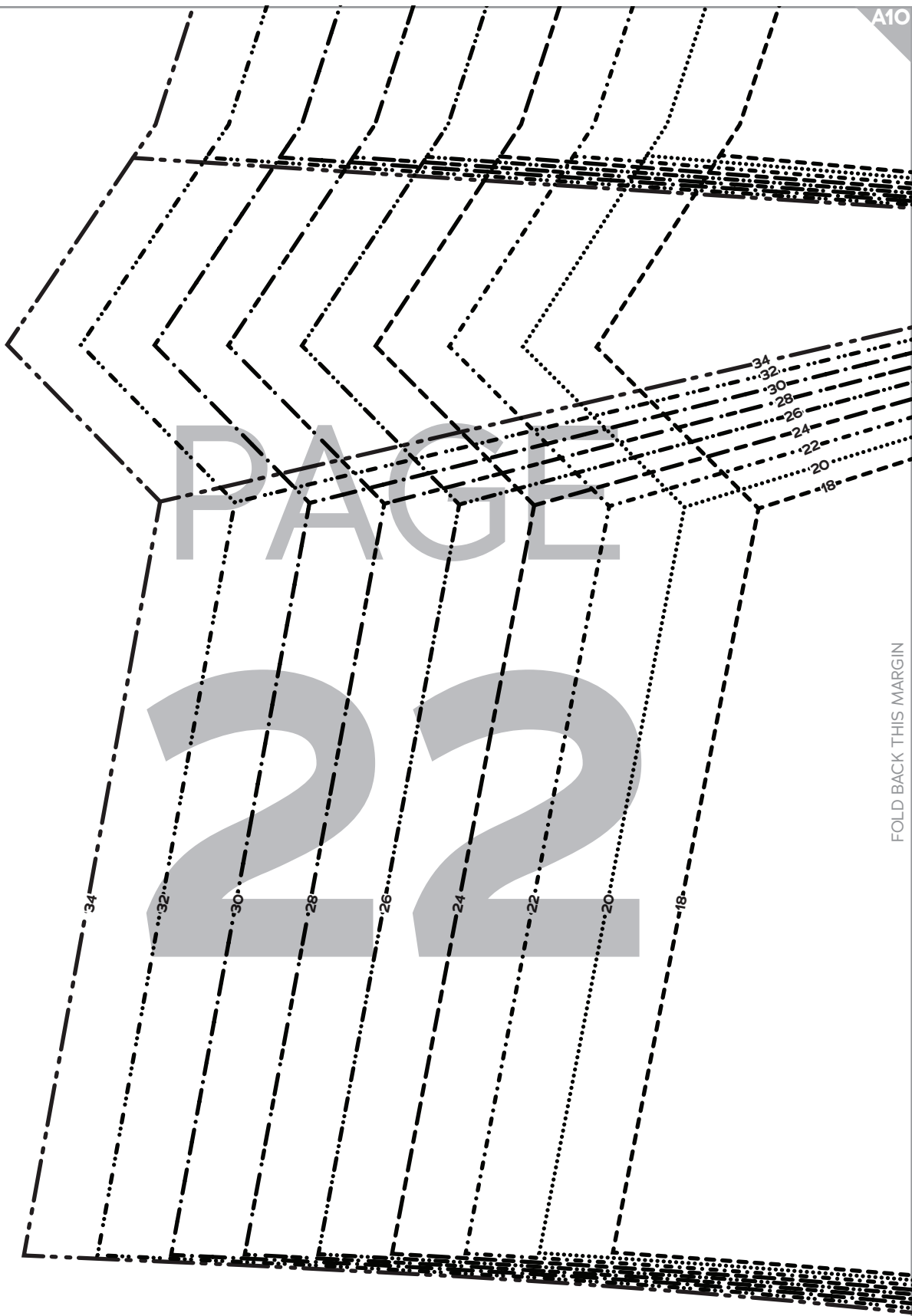

FOLD BACK THIS MARGIN

FOLD BACK THIS MARGIN

B9

B10

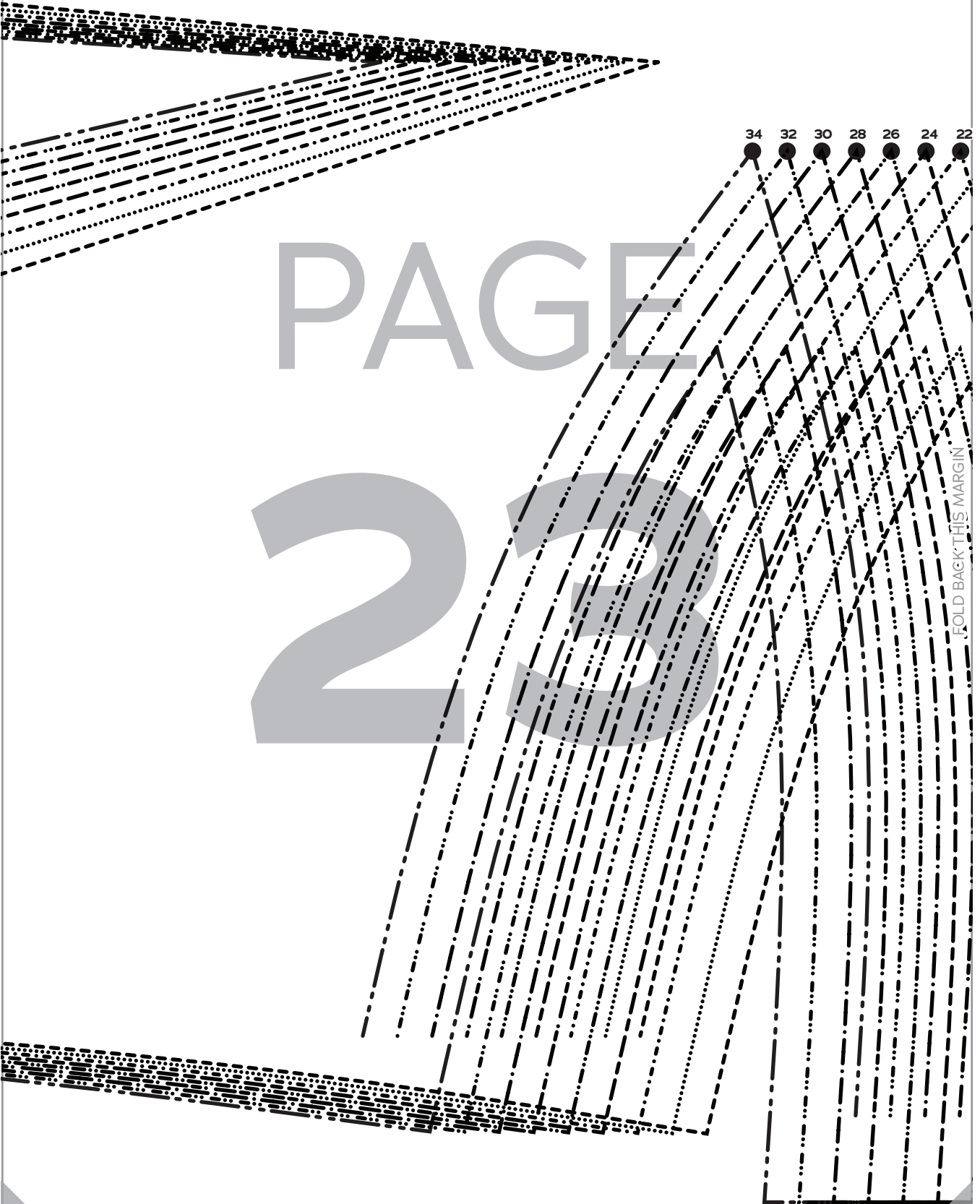

PAGE

23

FOLD BACK THIS MARGIN

A11

20 18

PAGE

24

GRAINLINE

FOLD BACK THIS MARGIN

B11



PAGE

25

FOLD BACK THIS MARGIN

FOLD BACK THIS MARGIN

B1

B2

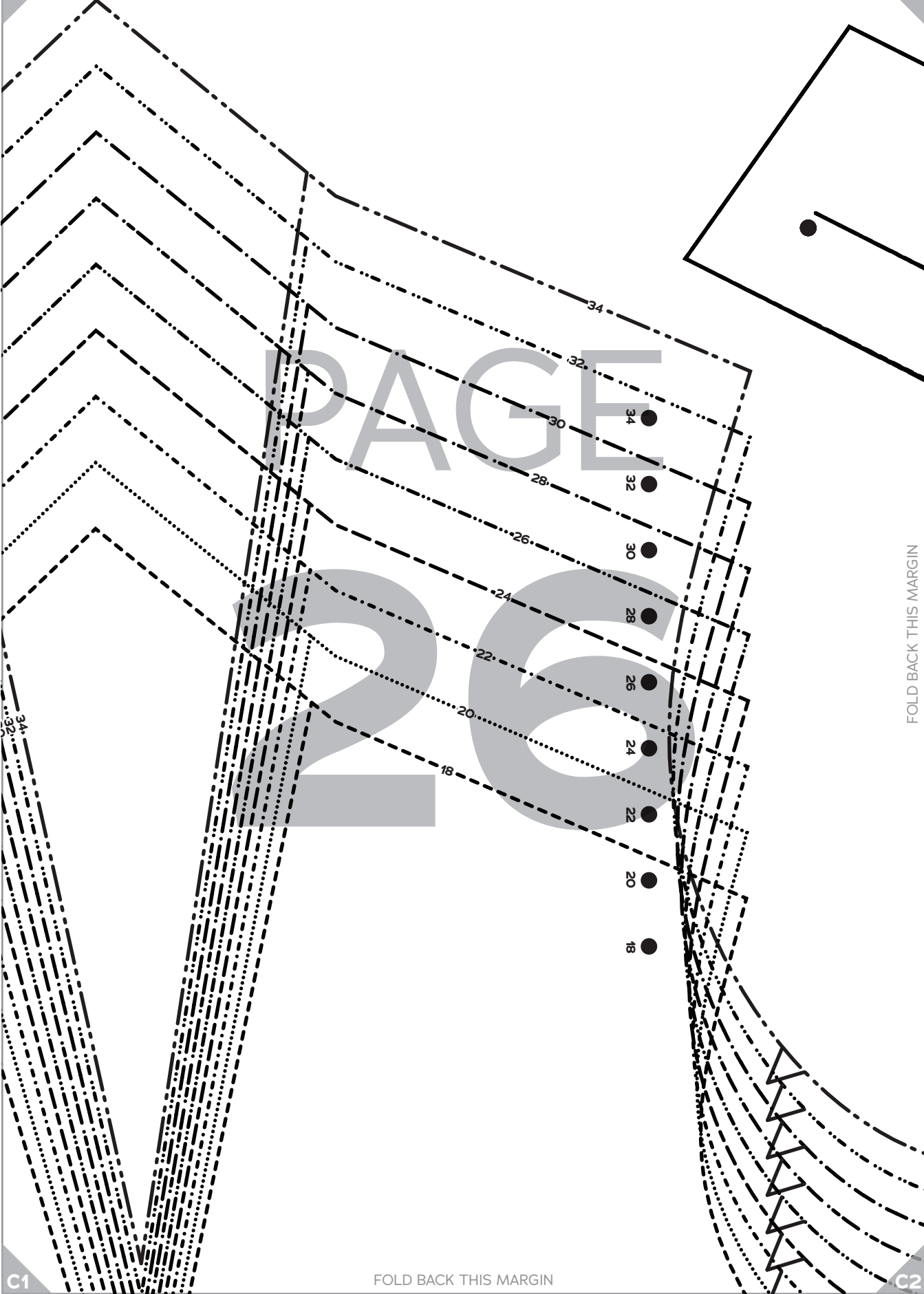

C1

FOLD BACK THIS MARGIN

C2

B2

B3

PAGE

27

BONING CHANNEL

FOLD BACK THIS MARGIN

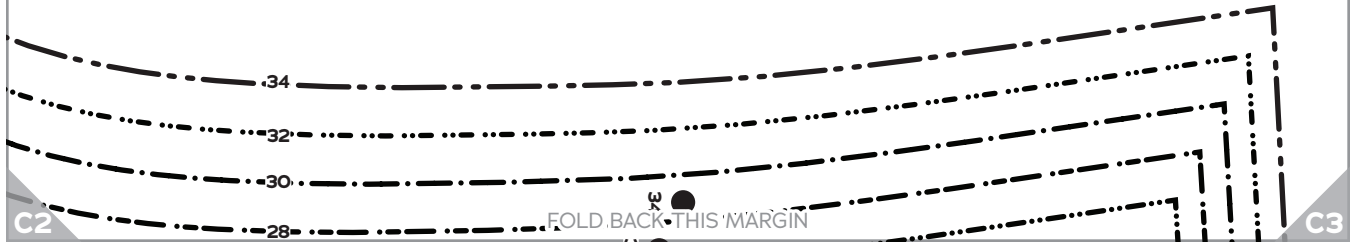
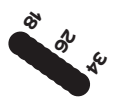

C2

C3

PAGE

28

Society of Charm Patterns  
Aurora Bodice  
SIZES 18-34

5  
Overlay Front  
Facing, D/DD Cup  
Cut 2 fabric, 2 interfacing

FOLD BACK THIS MARGIN

GRAINLINE

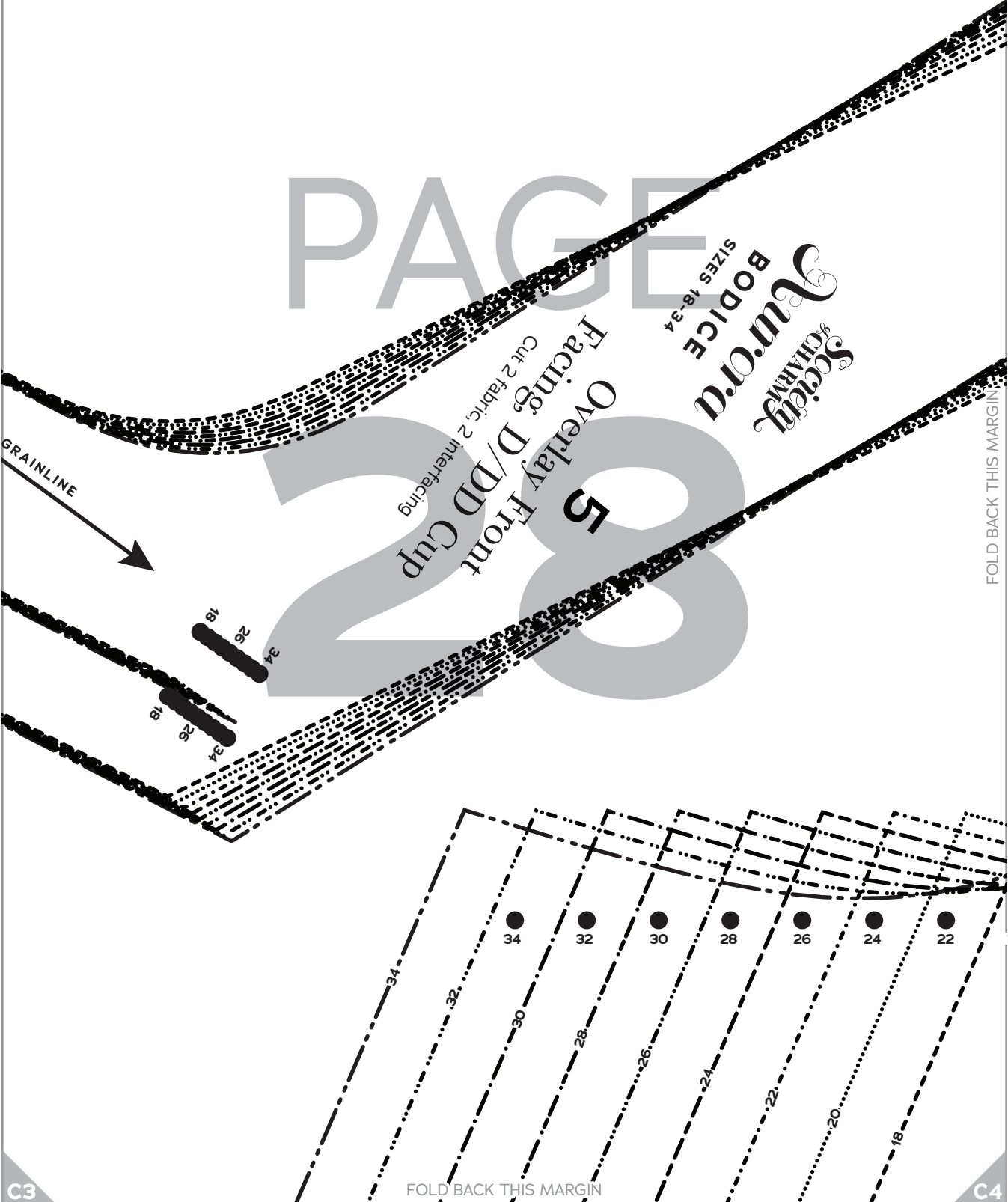

B4

B5

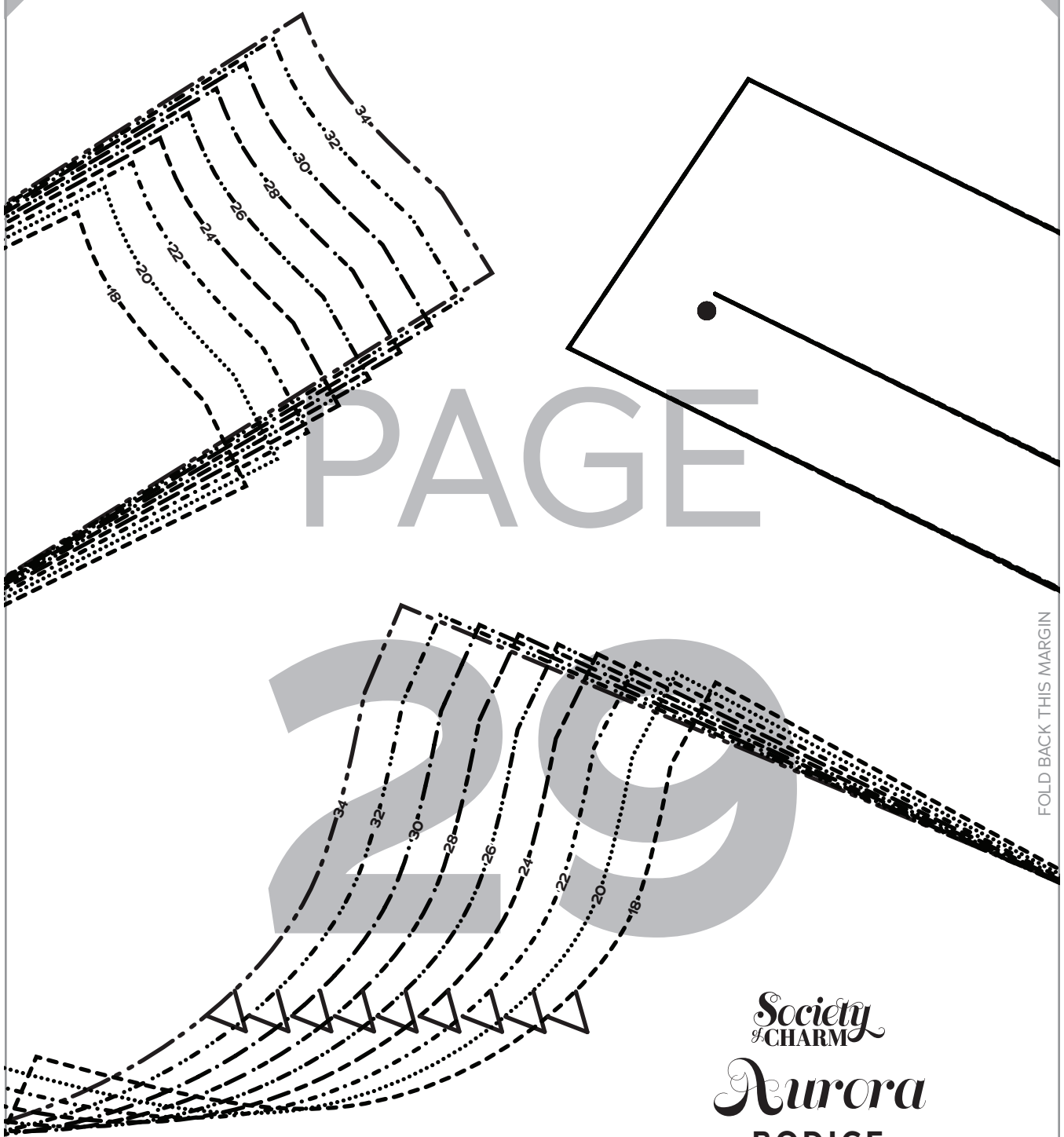

FOLD BACK THIS MARGIN

●  
20

●  
18

*Society*  
of CHARM

*Aurora*

**BODICE**

SIZES 18-34

**3**

Corset Overlay  
Front, D/DD Cup

Cut 2 fabric

C4

FOLD BACK THIS MARGIN

C5

B5

B6

PAGE

30

18  
34

18  
34

BONING CHANNEL

18  
26  
34

FOLD BACK THIS MARGIN  
GRAIN

34  
26  
18

FOLD BACK THIS MARGIN

C5

C6

B6

B7

PAGE

*Society of Charm*  
**Aurora**  
BODICE  
SIZES 18-34

**5**  
Overlay Front Facing, H Cup  
Cut: 2 Fabric, 2 Interfacing

FOLD BACK THIS MARGIN

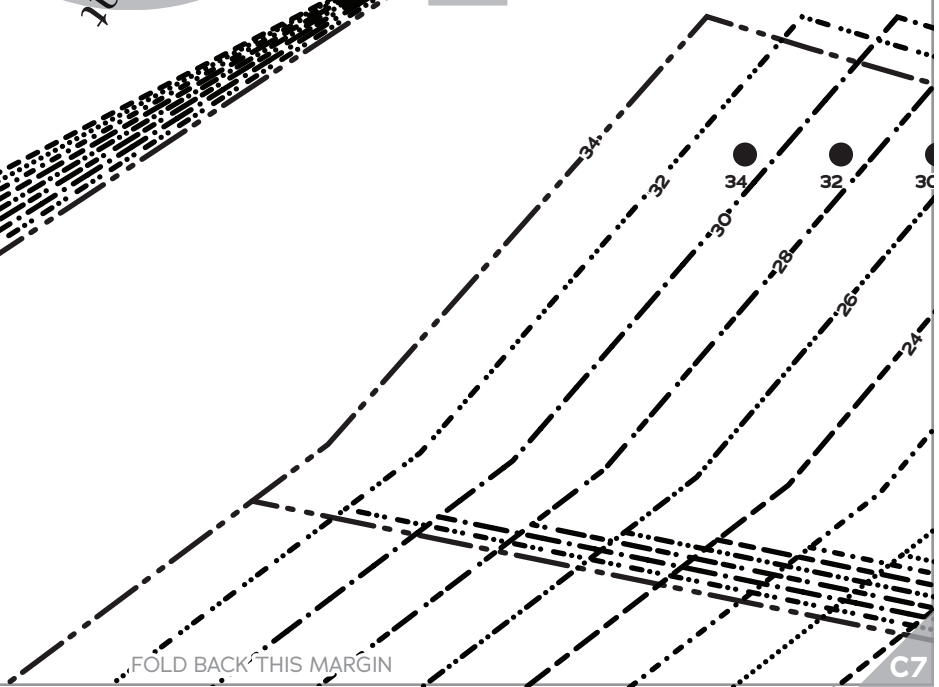
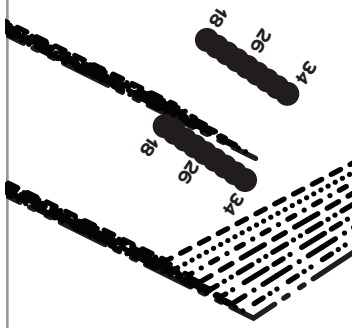
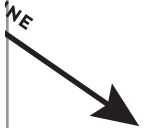

C6

FOLD BACK THIS MARGIN

C7

B7

B8

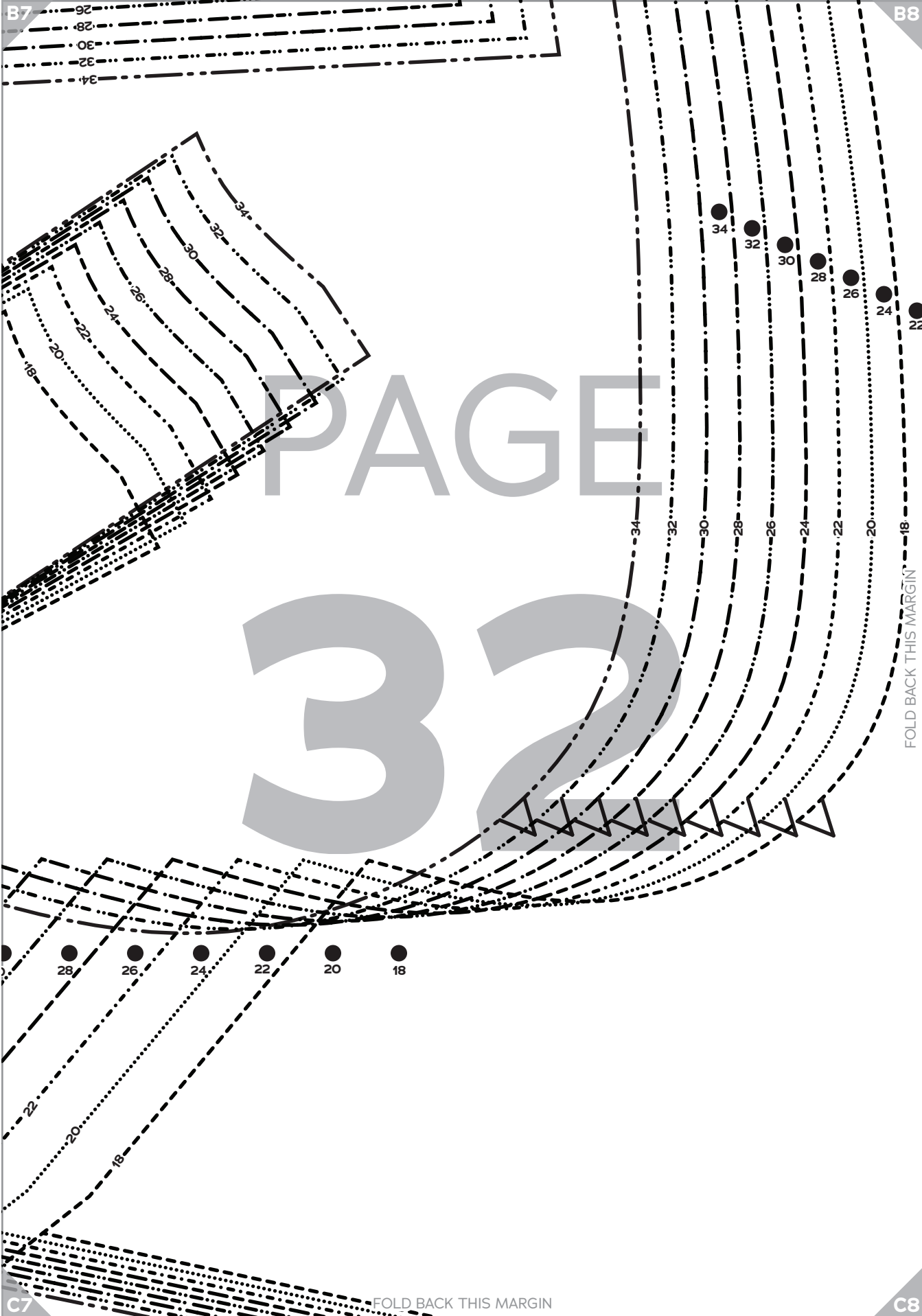

PAGE

32

FOLD BACK THIS MARGIN

FOLD BACK THIS MARGIN

C7

C8



B8

B9

●  
20 ●  
18

PAGE

33

*Society*  
of CHARM

*Aurora*

**BODICE**

SIZES 18-34

**1**

Bodice Front,  
F/G Cup

Cut 1 fabric on fold,  
1 lining on fold

FOLD BACK THIS MARGIN

C8

FOLD BACK THIS MARGIN

C9

B9

B10

PAGE

34

FOLD BACK THIS MARGIN



FOLD BACK THIS MARGIN

C9

C10

PAGE

35

FOLD BACK THIS MARGIN

FOLD BACK THIS MARGIN

Society of CHARM  
*Aurora*  
BODICE  
SIZES

5  
Overlay Front Facing, F/G Cup  
Cut 2 fabric, 2 interfacing

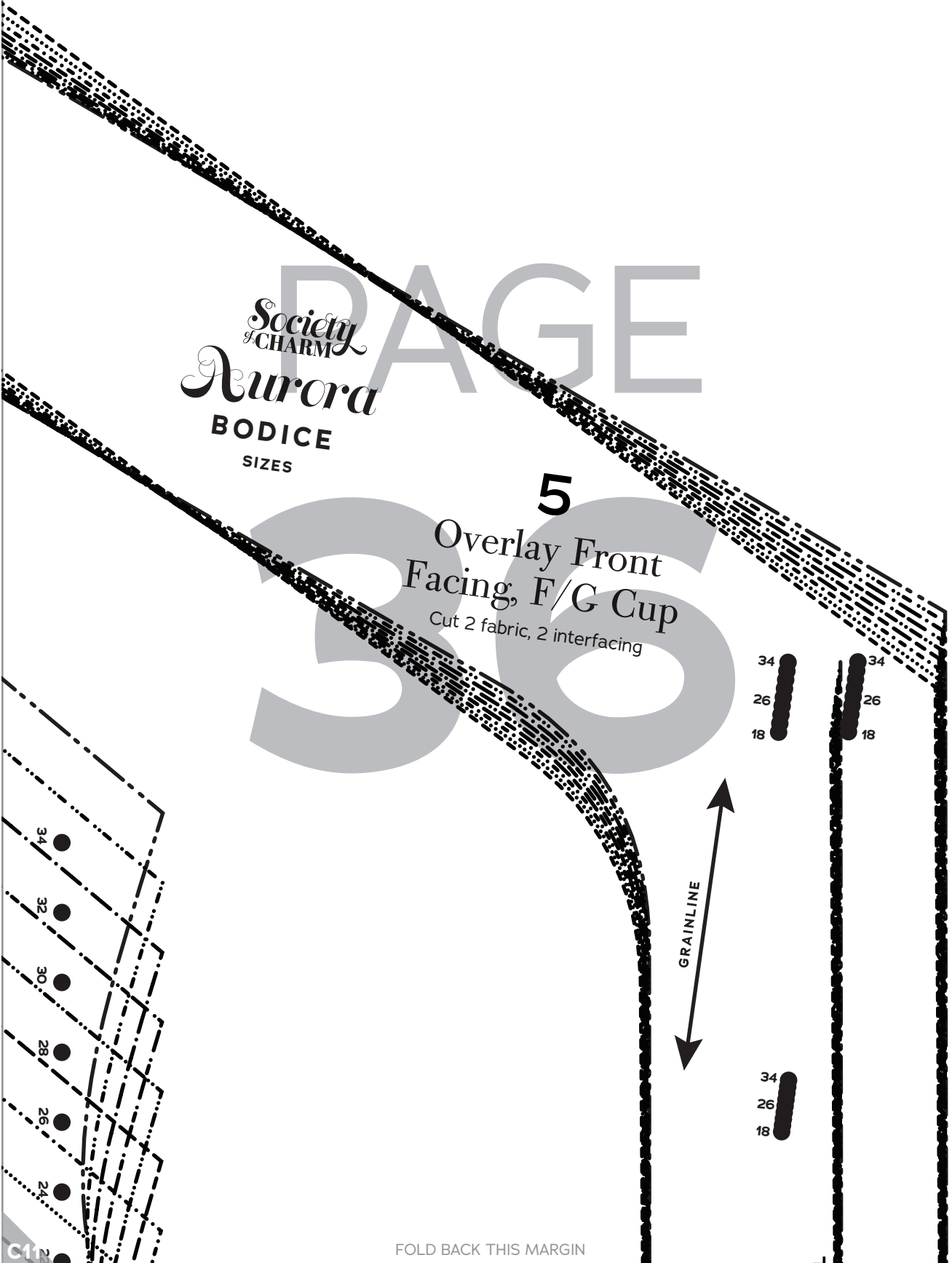

FOLD BACK THIS MARGIN

C1

PAGE  
37

FOLD BACK THIS MARGIN



FOLD BACK THIS MARGIN

D1

C1

C2

PAGE

38

*Aurora*  
Society  
of CHARM

**BODICE**  
SIZES 18-34

Bodice Front,  
D/DD Cup

Cut 1 fabric on fold,  
1 lining on fold

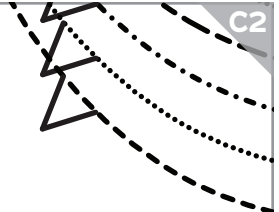
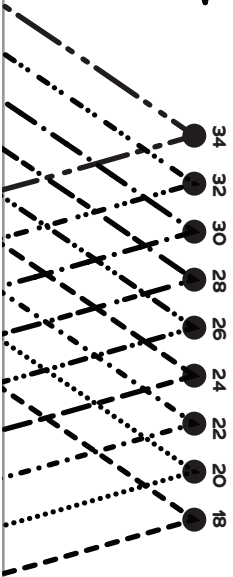

FOLD BACK THIS MARGIN

FOLD



D1

FOLD BACK THIS MARGIN

D2

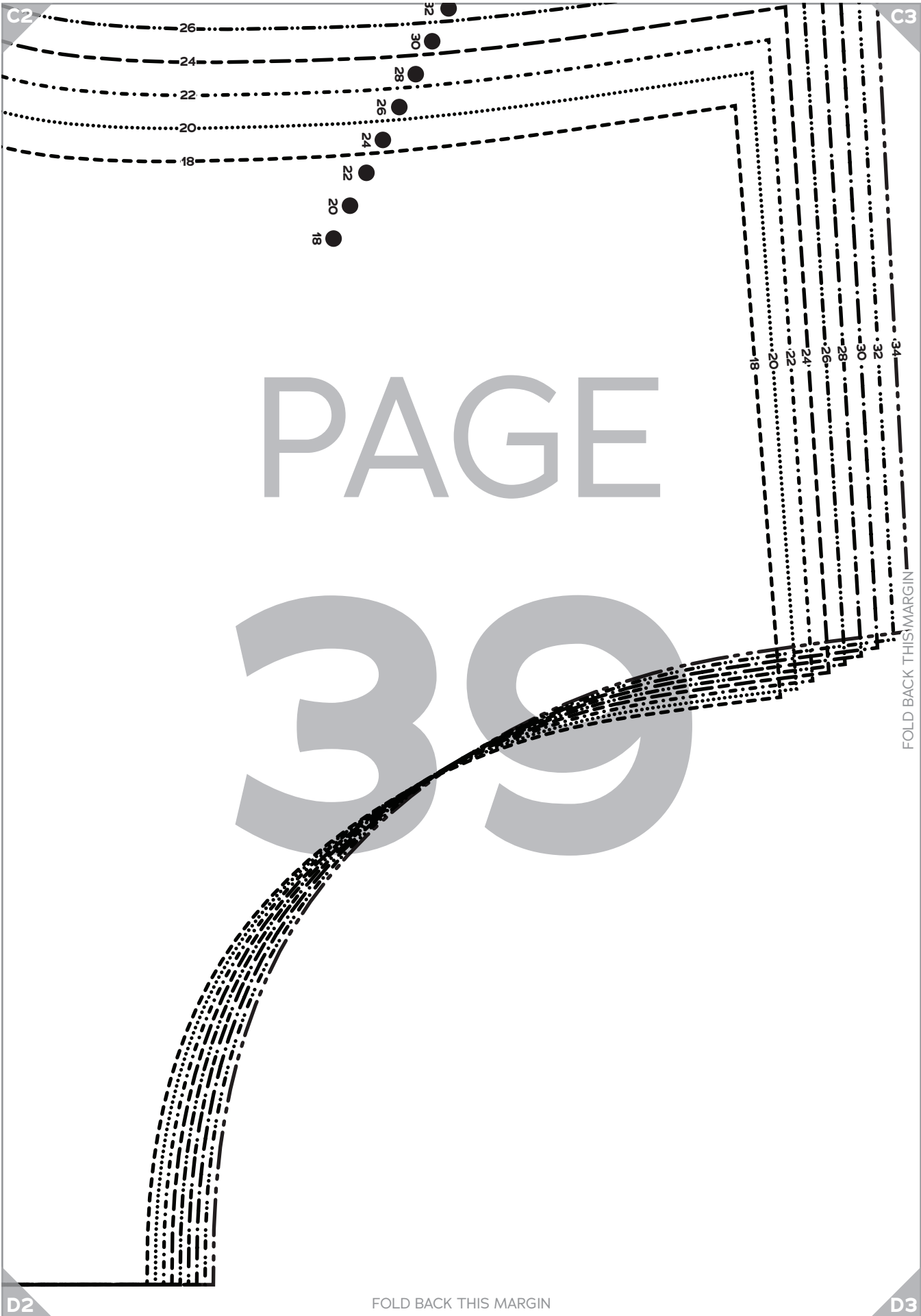

PAGE

39

D2

FOLD BACK THIS MARGIN

D3

C3

C4

PAGE  
40

FOLD BACK THIS MARGIN

D3

FOLD BACK THIS MARGIN

D4



C4

C5

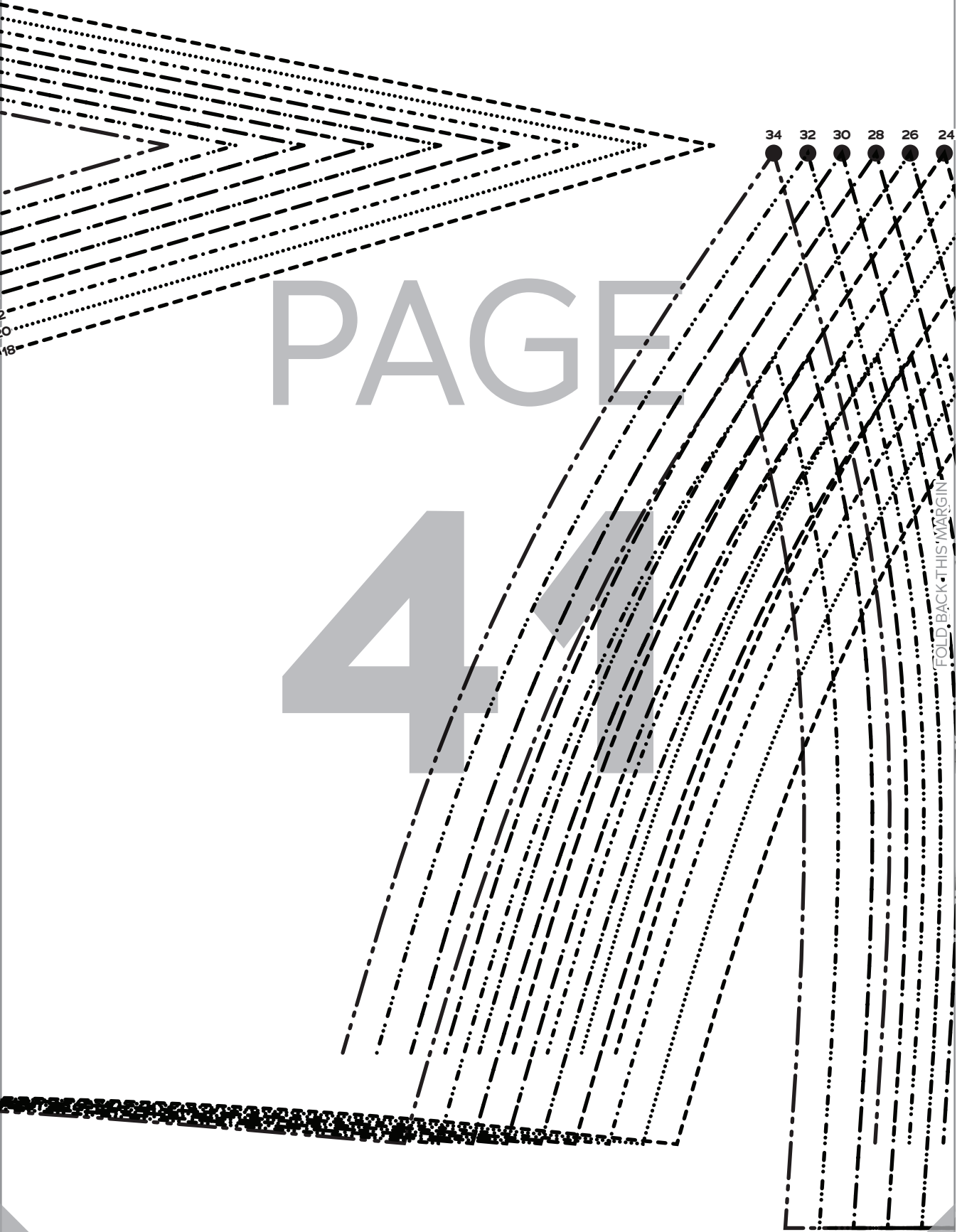

PAGE  
44

FOLD BACK THIS MARGIN

D4

FOLD BACK THIS MARGIN

D5

C5

C6

22 20 18

PAGE

42

GRAINLINE

FOLD BACK THIS MARGIN

D5

FOLD BACK THIS MARGIN

D6

C6

C7

PAGE

43

34

32

30

28

26

24

22

20

FOLD BACK THIS MARGIN

D6

FOLD BACK THIS MARGIN

D7

C7

C8

34  
 32  
 30  
 28  
 26  
 24  
 22  
 20  
 18

PAGE

44

FOLD BACK THIS MARGIN

D7

FOLD BACK THIS MARGIN

D8

C8

C9

34 32 30 28 26 24 22 20 18



FOLD BACK THIS MARGIN

D8

FOLD BACK THIS MARGIN

D9

C9

C10

FOLD

PAGE  
46

FOLD BACK THIS MARGIN

FOLD BACK THIS MARGIN

D9

D10

C10

C11

PAGE

47

FOLD BACK THIS MARGIN

3

Corset Overlay  
Front, F/G Cup  
Cut 2 fabric

- 34
- 32
- 30
- 28
- 26
- 24
- 22
- 20
- 18

D10

FOLD BACK THIS MARGIN

D11

C11

20 ●  
18 ●

BONING CHANNEL

34  
18

34  
18

PAGE  
48

*Aurora*  
Society  
of CHARM  
BODICE  
SIZES 18-34

D11

FOLD BACK THIS MARGIN



# PAGE 49



FOLD BACK THIS MARGIN

- 18
- 20
- 22
- 24
- 26
- 28

FOLD BACK THIS MARGIN

D1

D2

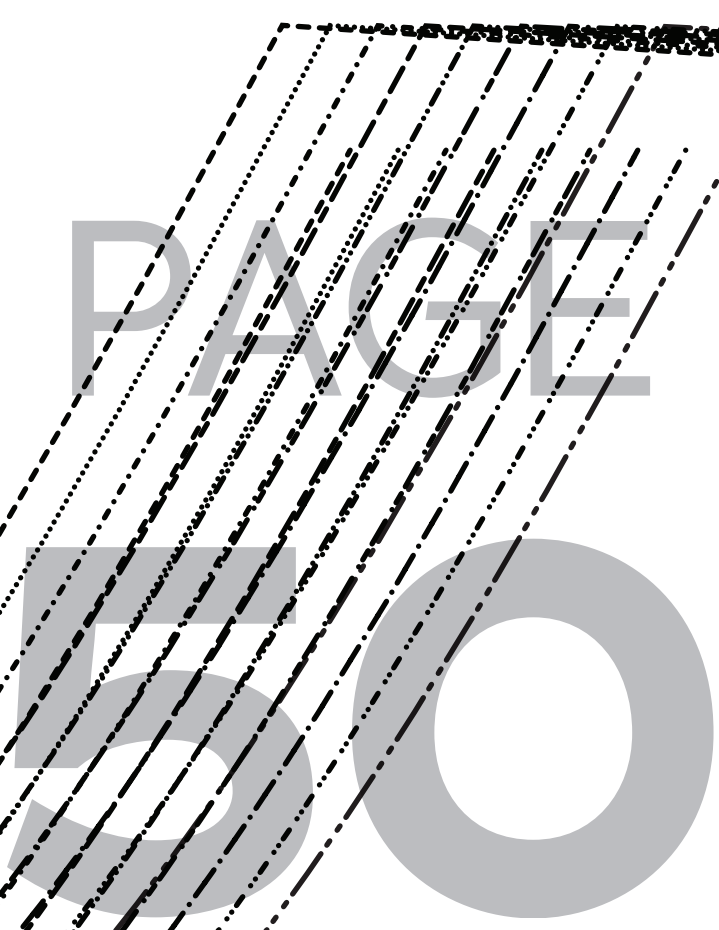

FOLD BACK THIS MARGIN

30 32 34

18  
20  
22  
24  
26  
28  
30  
32  
34

E1

FOLD BACK THIS MARGIN

E2

D2

D3

PAGE  
51

FOLD BACK THIS MARGIN

E2

FOLD BACK THIS MARGIN

E3

D3

D4

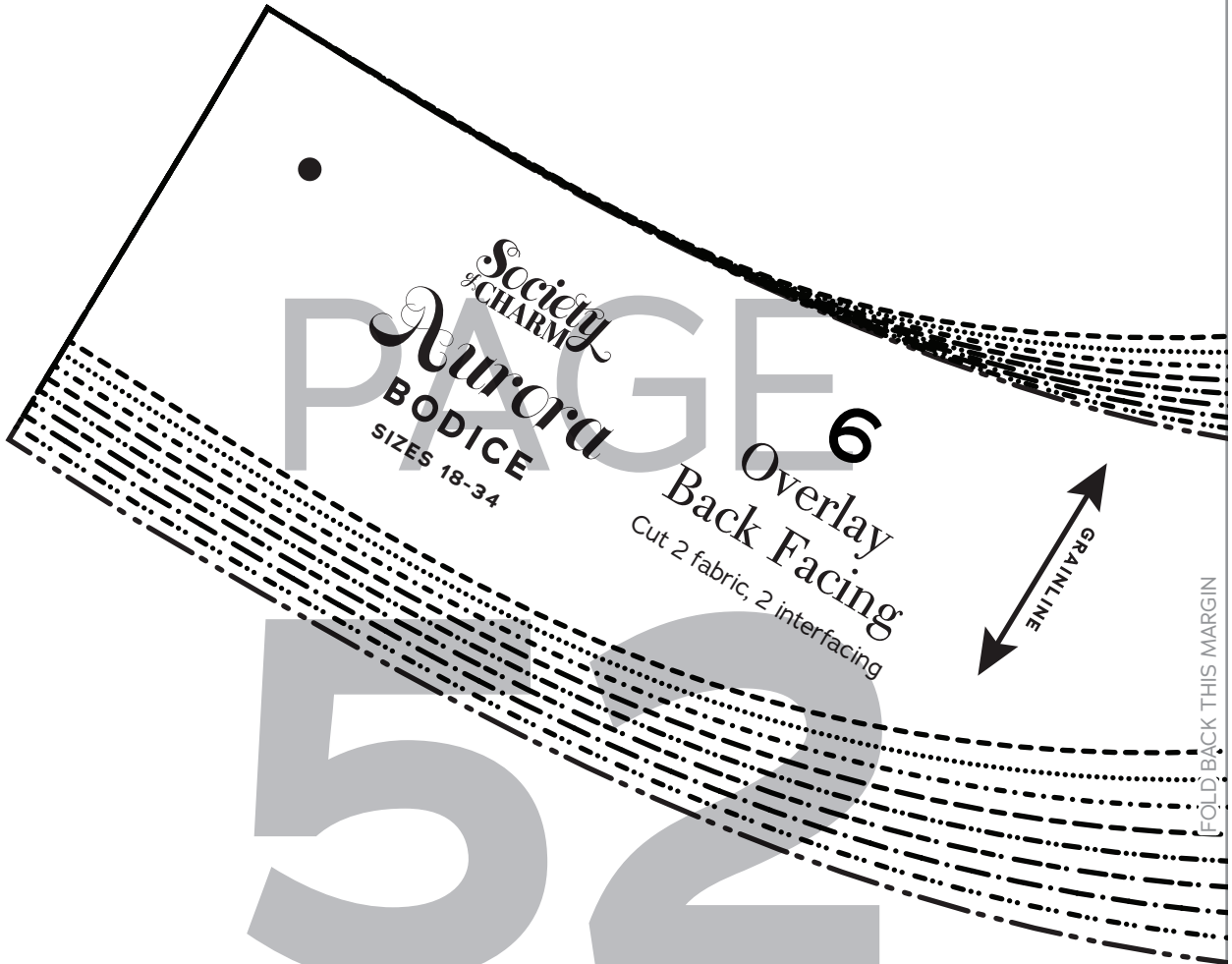

Society of Charm  
**Aurora**  
 BODICE  
 SIZES 18-34

**6**  
 Overlay  
 Back Facing  
 Cut 2 fabric, 2 interfacing

GRAINLINE

FOLD BACK THIS MARGIN

PAGE 52

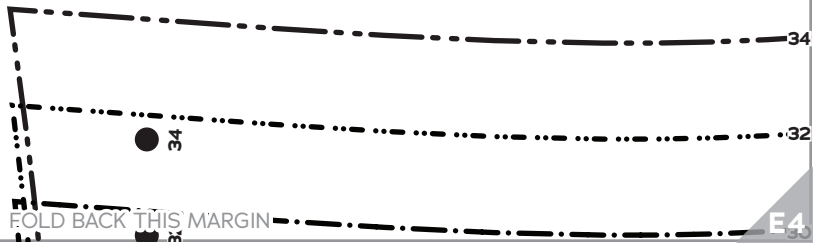
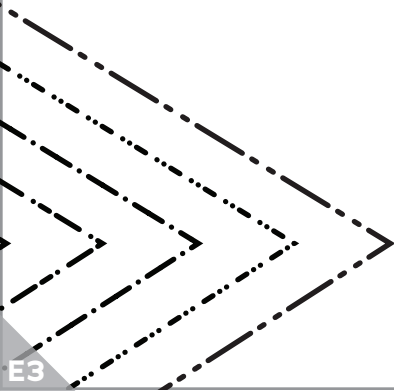

E3

FOLD BACK THIS MARGIN

E4

D4

D5

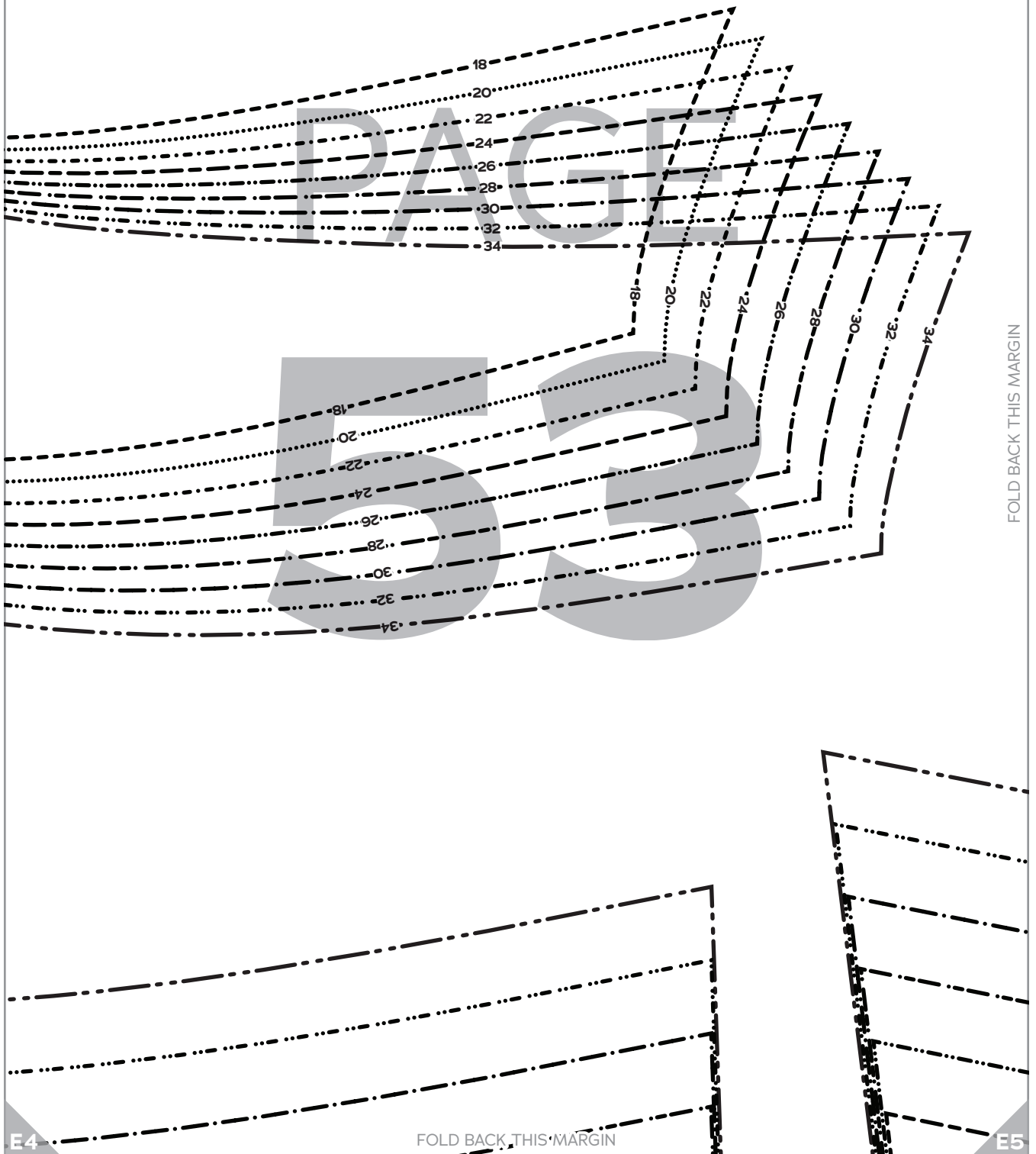

E4

E5

D5

D6

PAGE

54



FOLD BACK THIS MARGIN

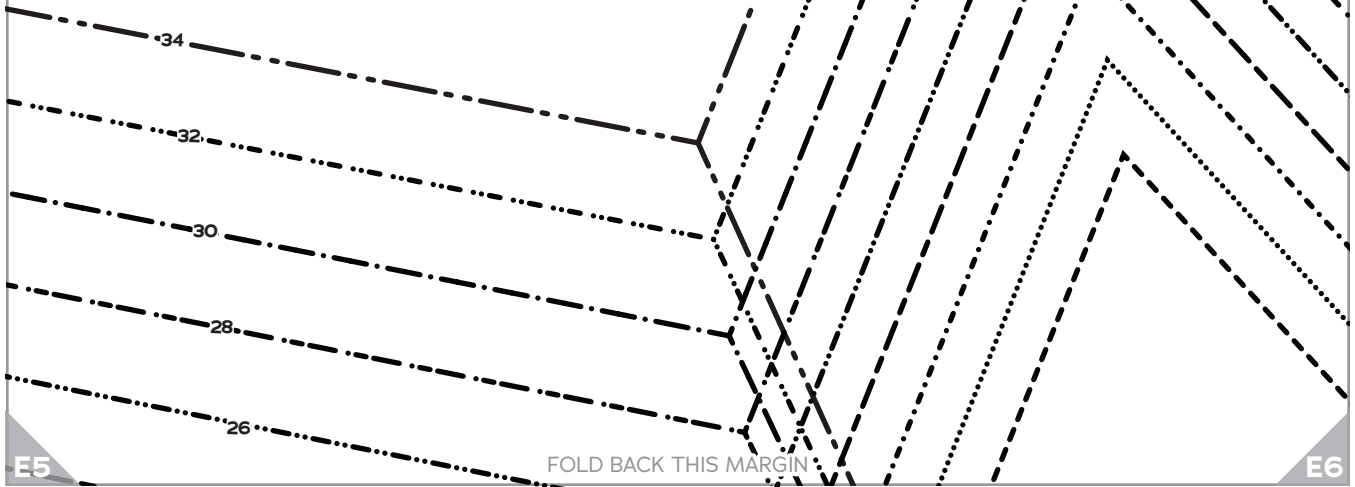

FOLD BACK THIS MARGIN

E5

E6

D6

D7

PAGE

55

FOLD BACK THIS MARGIN

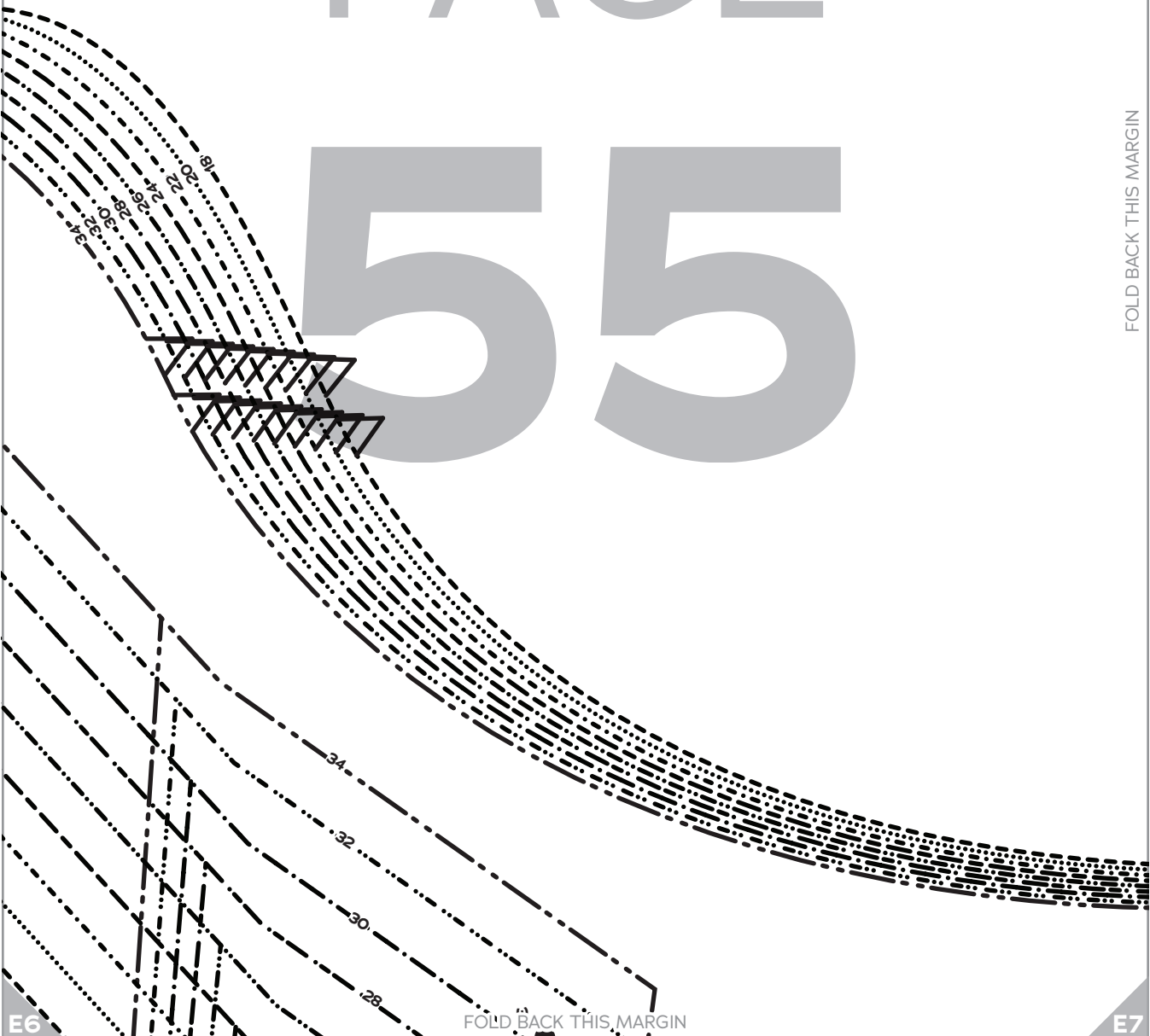

E6

FOLD BACK THIS MARGIN

E7

D7

D8

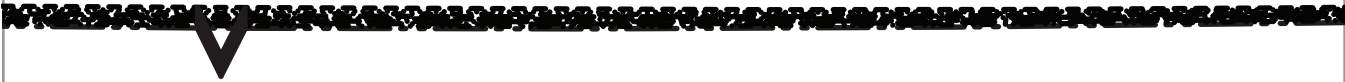

PAGE

Cap Sleeve  
Cut 2 fabric, 2 lining

10

SIZES 18-34

BODICE

*Aurora*

*Society of CHARM*

56

GRAINLINE



FOLD BACK THIS MARGIN

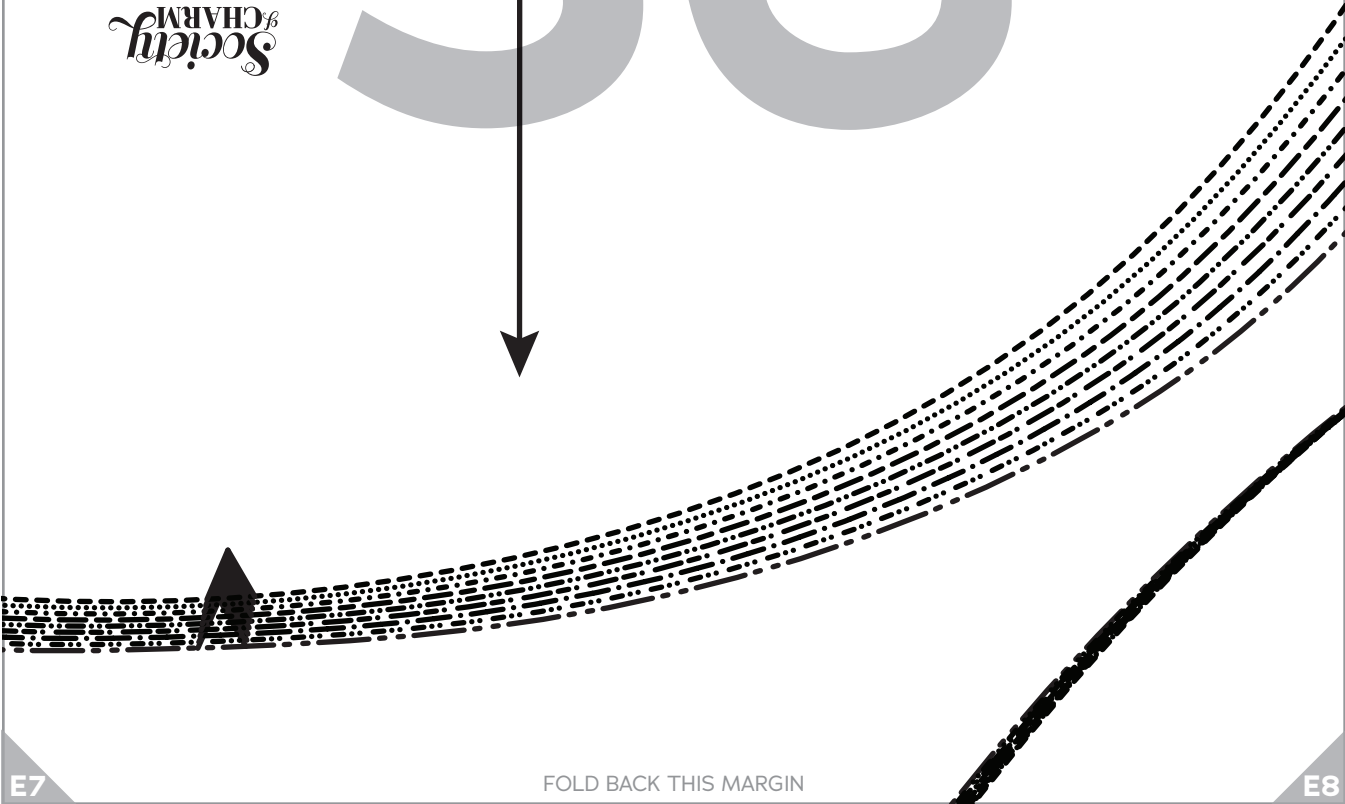

E7

FOLD BACK THIS MARGIN

E8



D8

D9

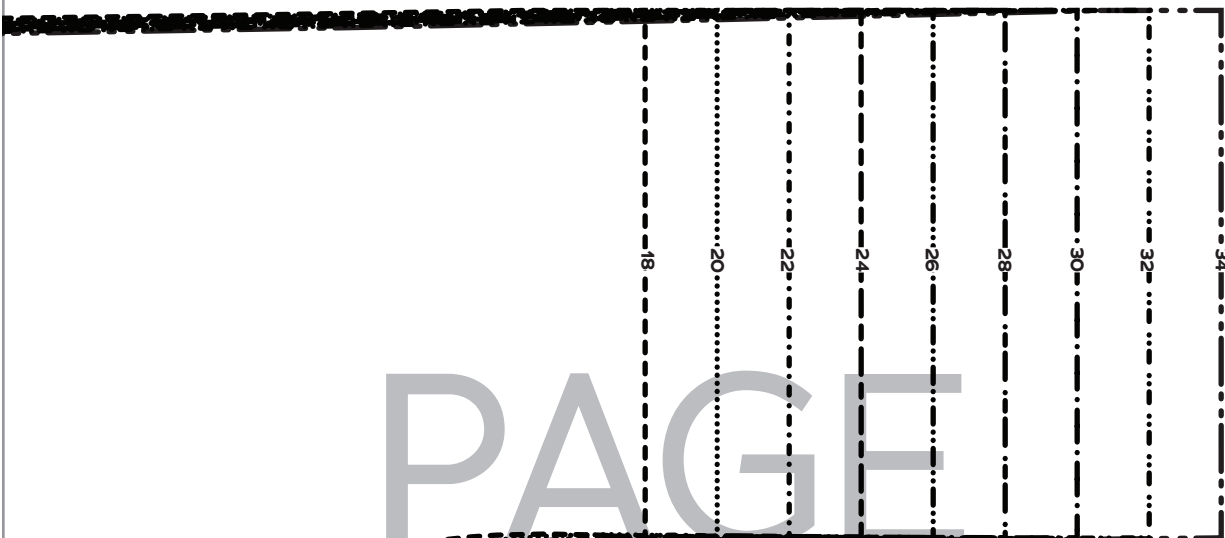

PAGE

57

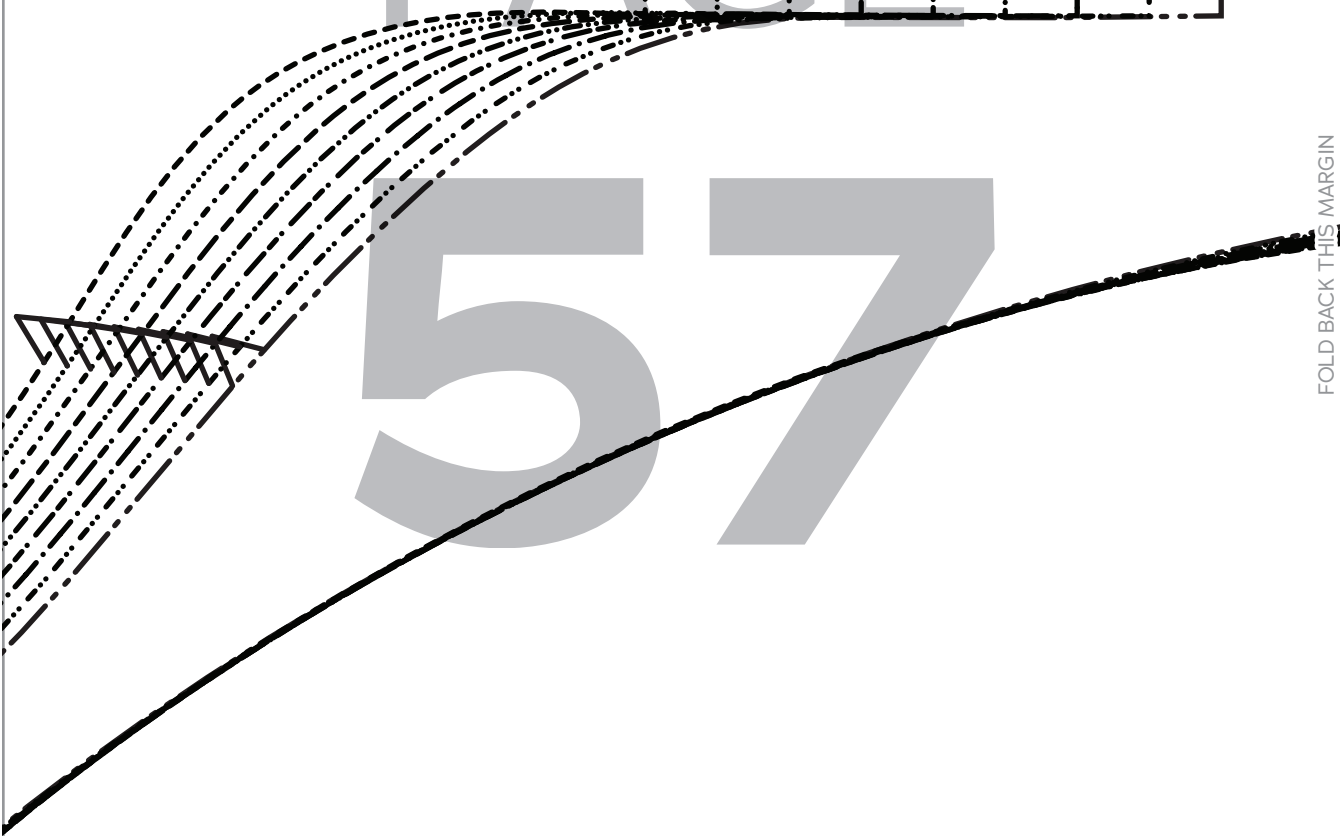

E8

E9

FOLD BACK THIS MARGIN

FOLD BACK THIS MARGIN

D9

D10



PAGE

58

FOLD BACK THIS MARGIN

18

20

22

E9

FOLD BACK THIS MARGIN

E10

D10

D11

GRAINLINE

34  
26  
18

PAGE

59

FOLD BACK THIS MARGIN

34  
32  
30  
28  
26  
24

34  
26  
18

FOLD BACK THIS MARGIN

E10

E11

D11

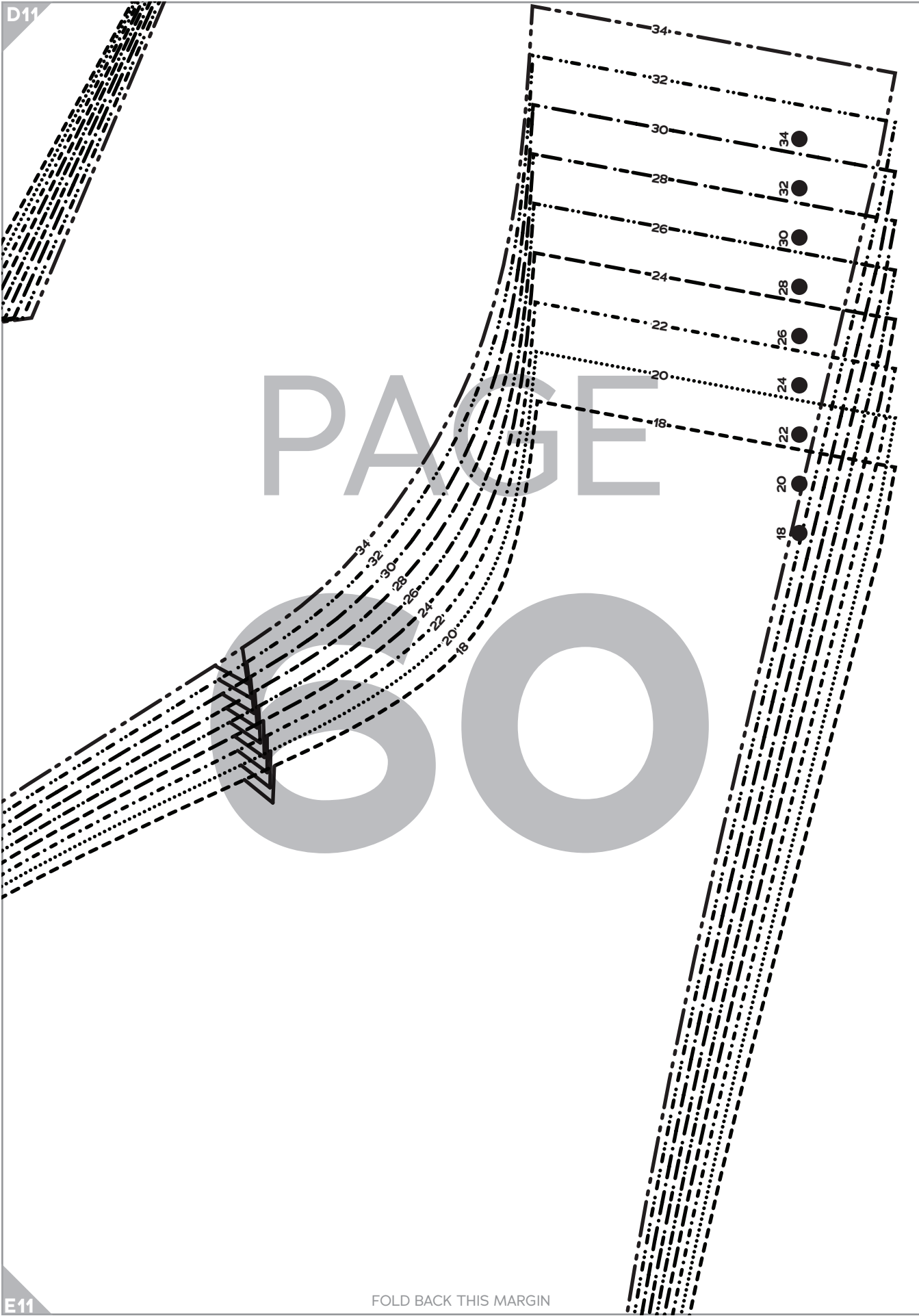

E11

FOLD BACK THIS MARGIN

FOLD

Bodice Front,  
H Cup  
Cut 1 fabric on fold,  
1 lining on fold

PAGE 1

SIZES 18-34

BODICE

*Aurora*

*Society  
of CHARM*

61

FOLD BACK THIS MARGIN



FOLD BACK THIS MARGIN

E1

E2

PAGE

62

FOLD BACK THIS MARGIN

18 ●  
 20 ●  
 22 ●  
 24 ●  
 26 ●  
 28 ●  
 30 ●  
 32 ●  
 34 ●

18 ●  
 20 ●  
 22 ●

F1

FOLD BACK THIS MARGIN

F2

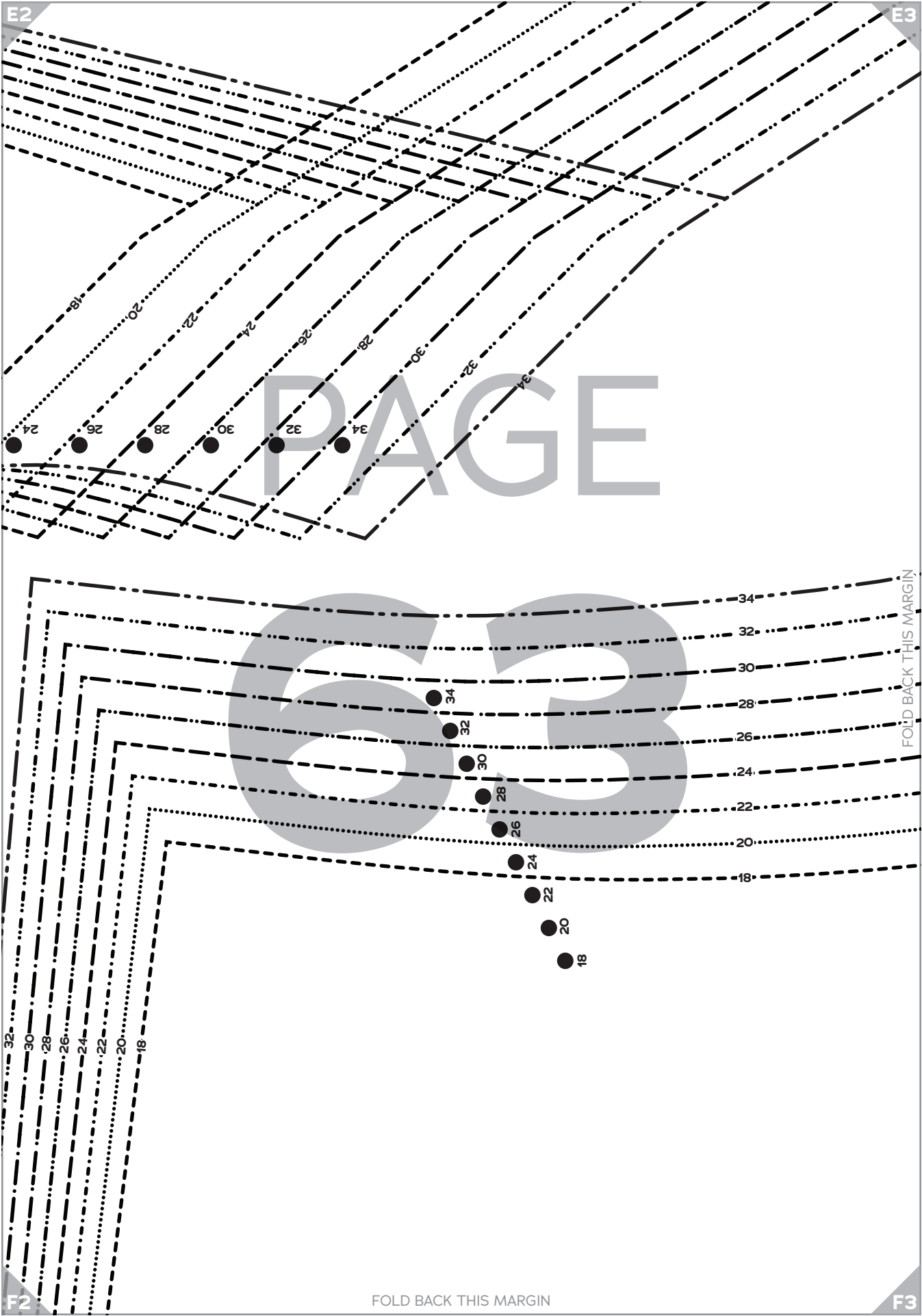

E3

E4

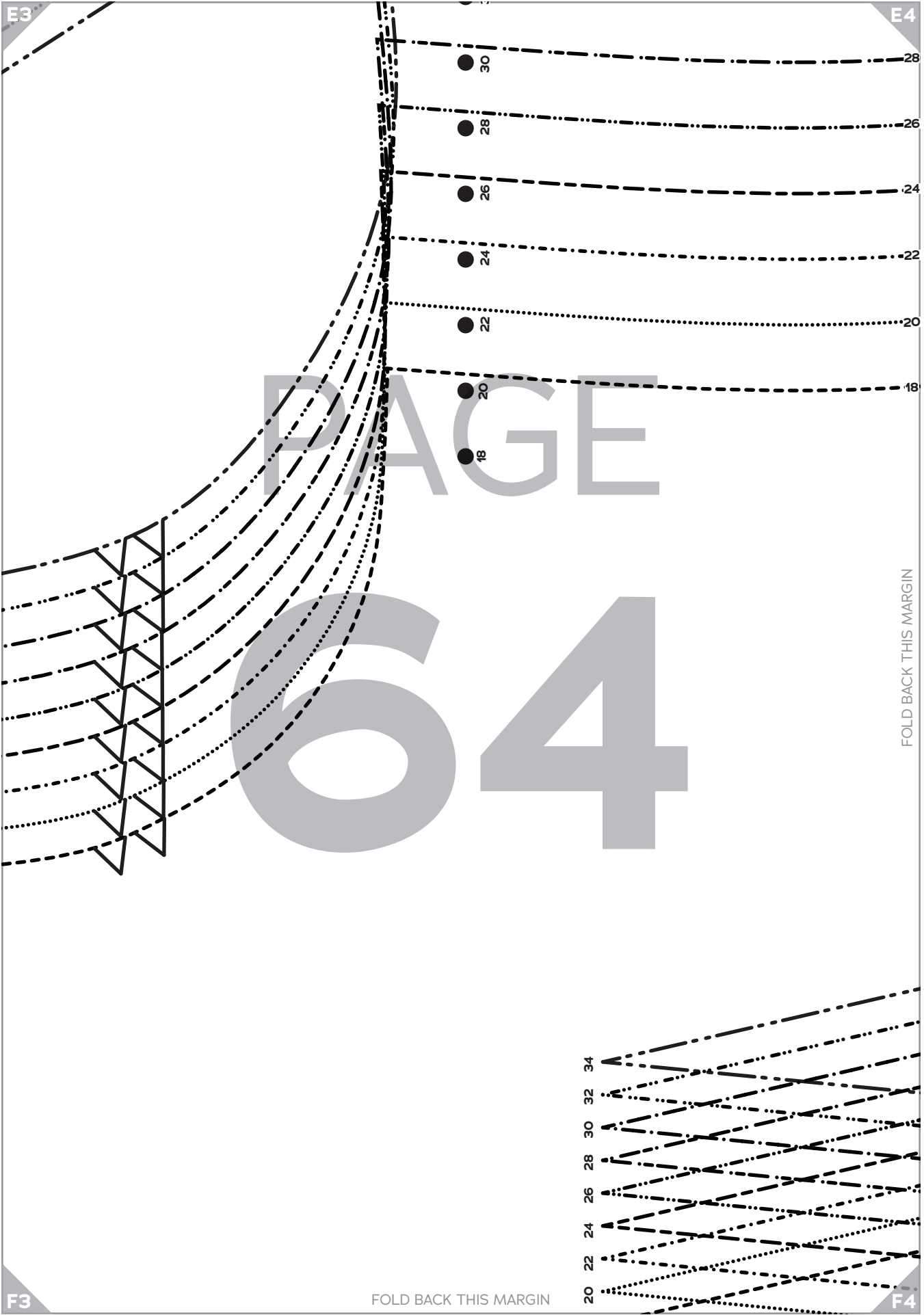

PAGE

64

FOLD BACK THIS MARGIN

FOLD BACK THIS MARGIN

F3

F4



E4

E5

PAGE

65

FOLD BACK THIS MARGIN

F4

FOLD BACK THIS MARGIN

F5

E5

E6

24

22

20

18

PAGE

66

FOLD BACK THIS MARGIN

F5

FOLD BACK THIS MARGIN

F6

E6

E7

PAGE  
67

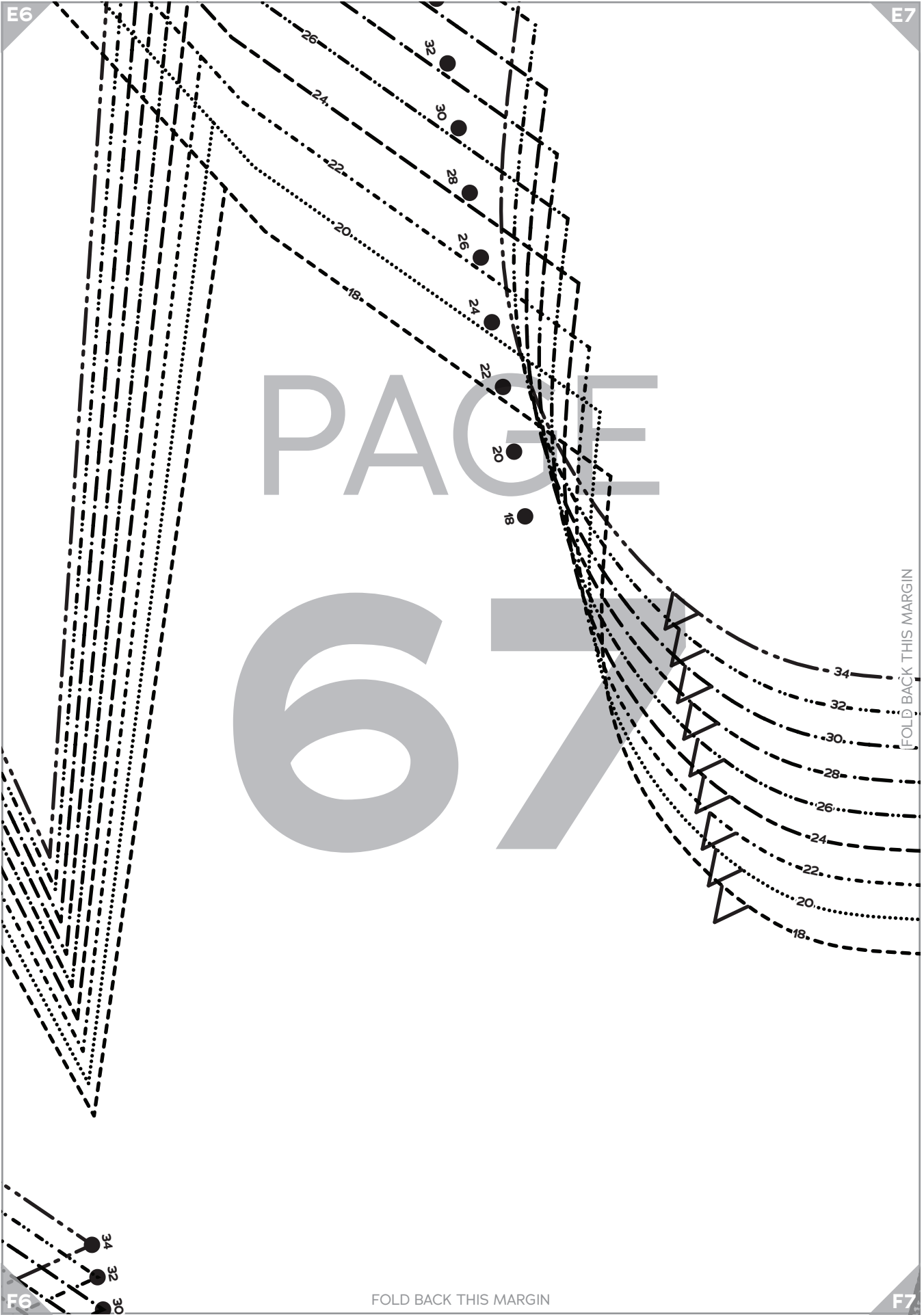

F6

F7

FOLD BACK THIS MARGIN

E7

E8

PAGE

68

FOLD BACK THIS MARGIN



GRAINLINE

*Society*  
of CHARM  
*Aurora*

**BODICE**

SIZES 18-34

**7**

**Peplum**

Cut 4 fabric

F7

FOLD BACK THIS MARGIN

F8

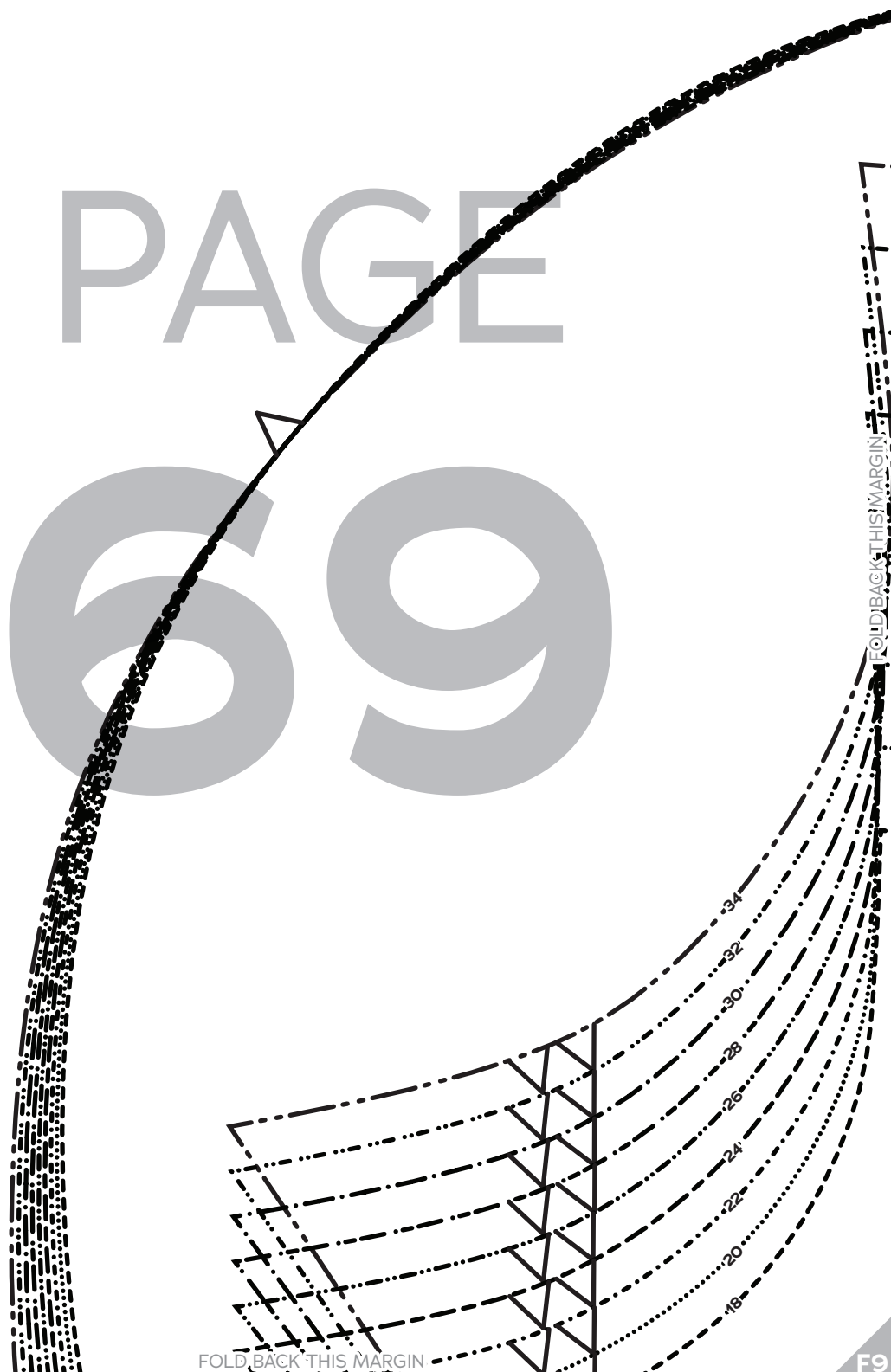

PAGE

69

FOLD BACK THIS MARGIN

FOLD BACK THIS MARGIN

E9

E10

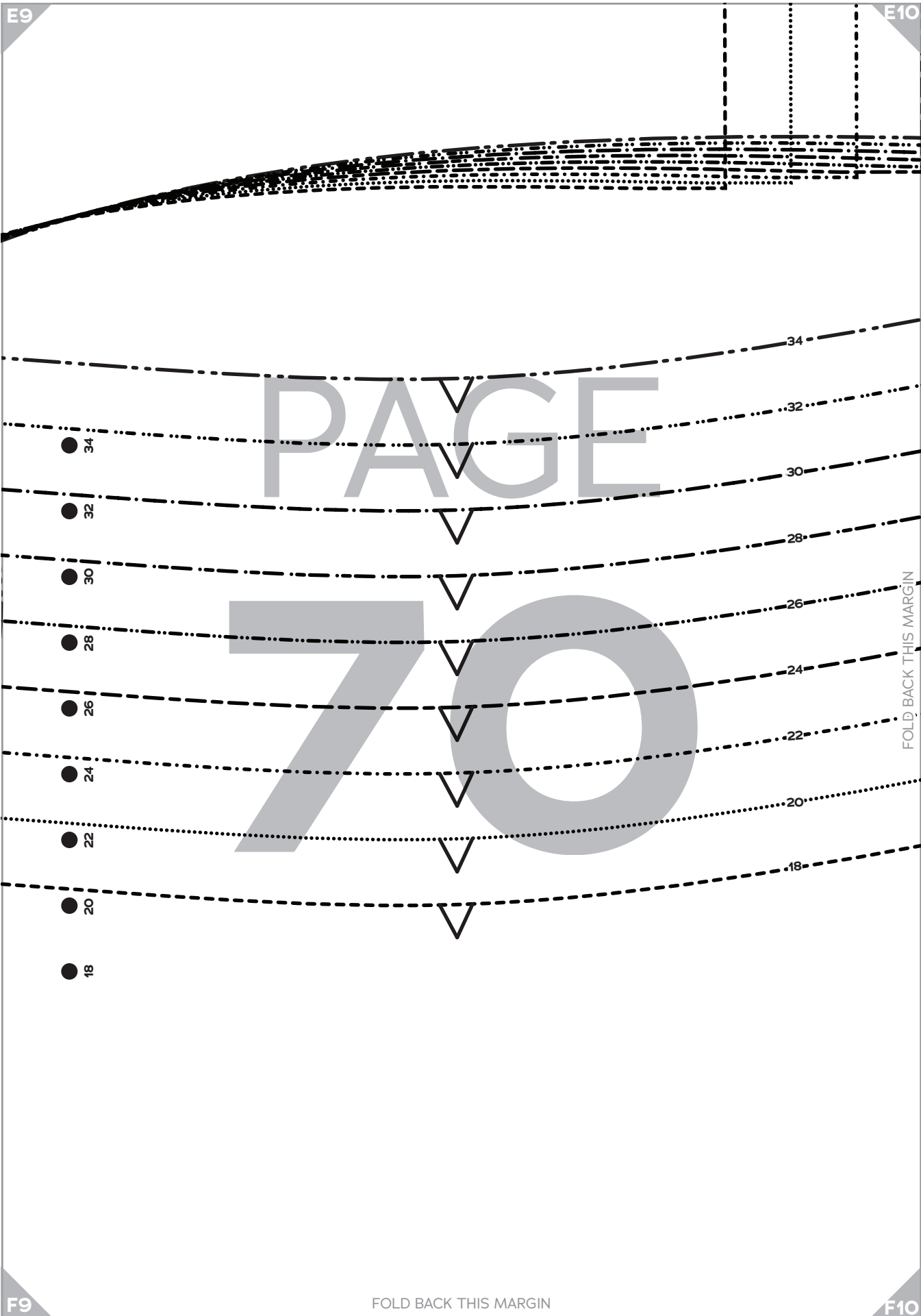

PAGE

70

FOLD BACK THIS MARGIN

F9

FOLD BACK THIS MARGIN

F10

E10

E11

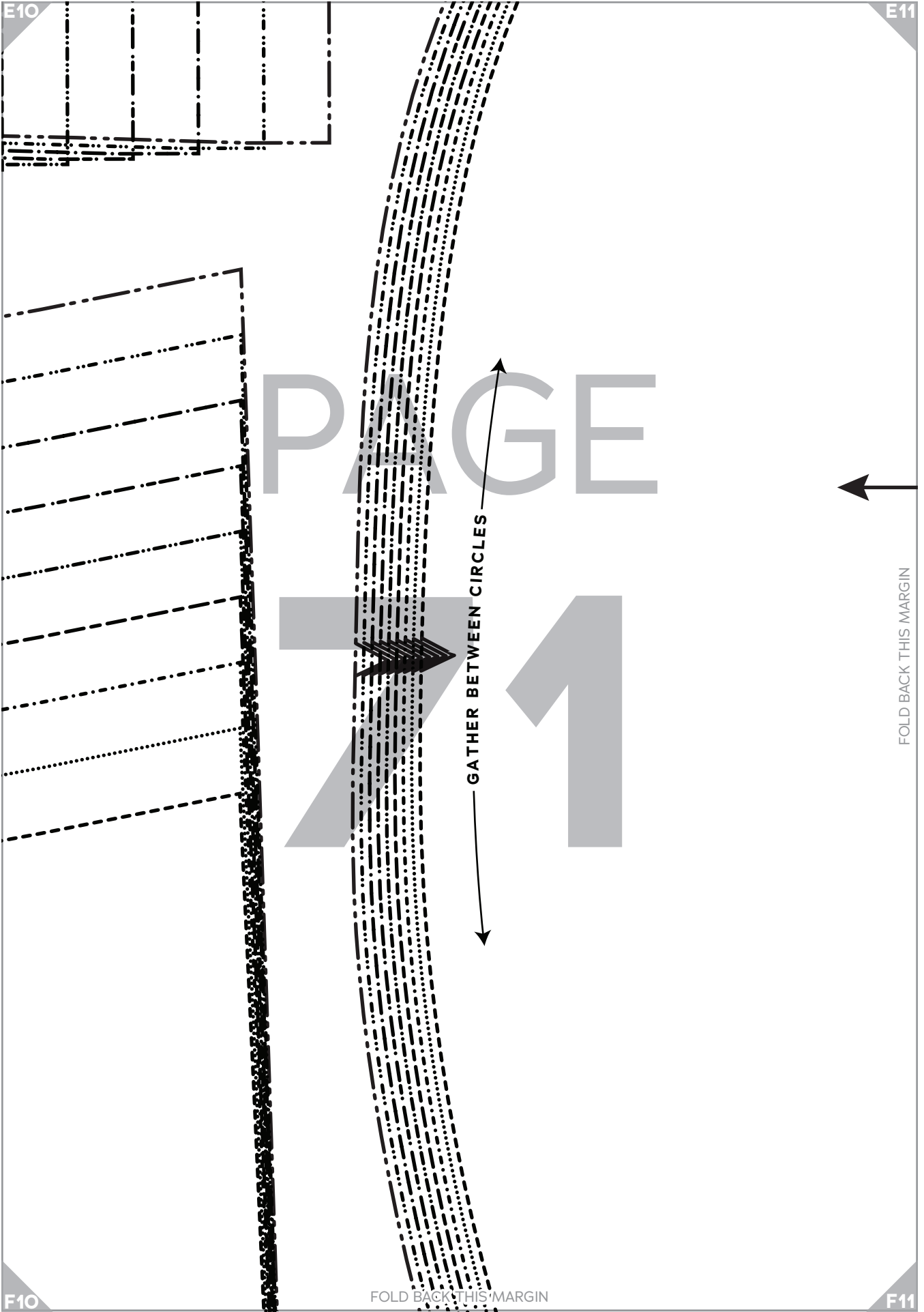

PAGE 71

F10

FOLD BACK THIS MARGIN

F11

*Society*  
of CHARM  
*Aurora*

**BODICE**  
SIZES 18-34

**8**

**Puff Sleeve**

Cut 2 fabric

GRAINLINE

GATHER BETWEEN CIRCLES

PAGE 72



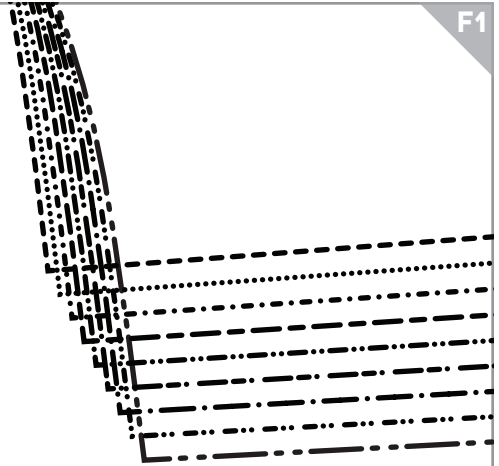

PAGE

73

FOLD BACK THIS MARGIN

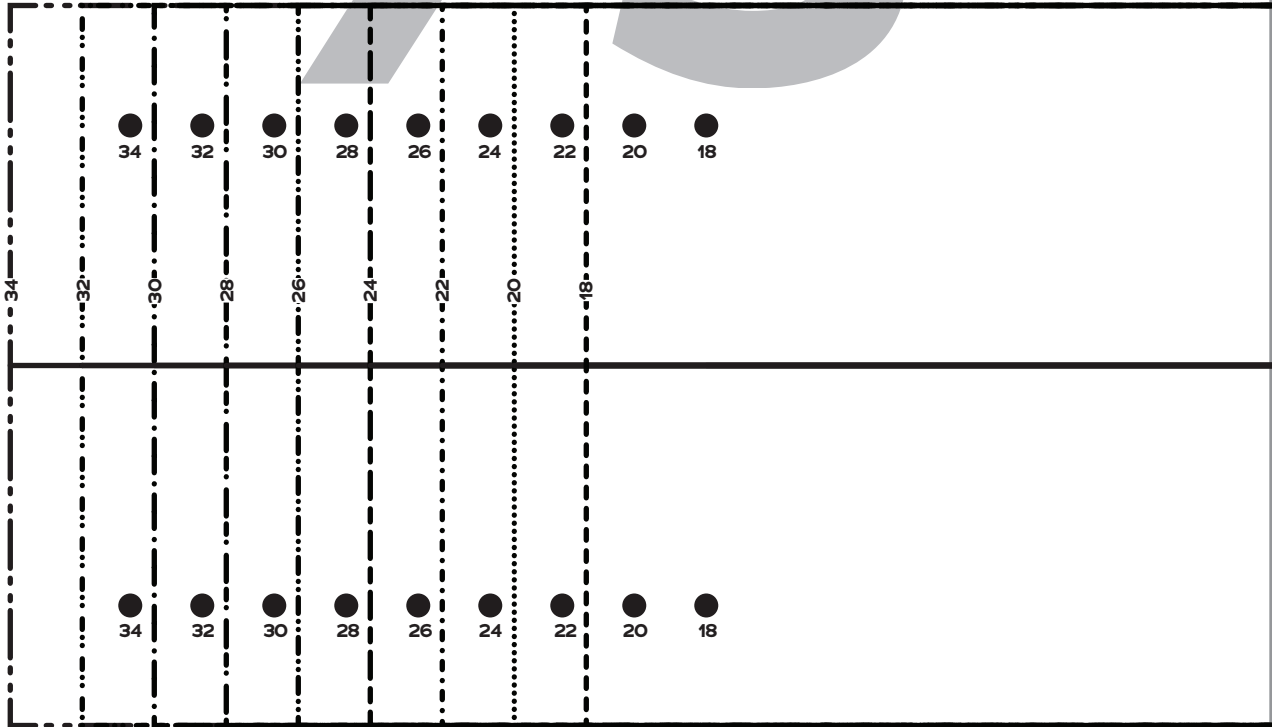

F1

F2

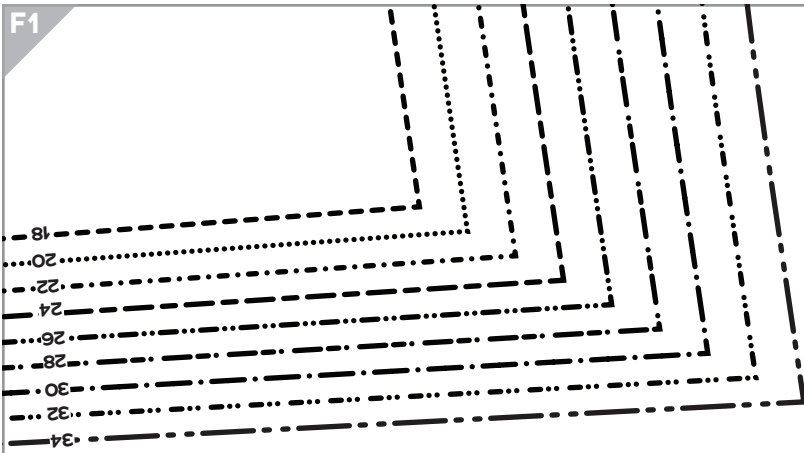

PAGE

74

FOLD BACK THIS MARGIN

*Society*  
 of CHARM  
*Aurora*  
**BODICE**  
 SIZES 18-34

**9**  
 Puff Sleeve  
 Band

Cut 2 fabric,  
2 interfacing



F2

F3

34  
 32  
 30  
 28  
 26  
 24  
 22  
 20  
 18

PAGE

75



FOLD BACK THIS MARGIN

FOLD LINE

F3

F4

Society of CHARM  
*Aurora*

**BODICE**  
SIZES 18-34

**2**

Bodice  
Back

Cut 2 fabric, 2 lining

GRAINLINE

PAGE

76

FOLD BACK THIS MARGIN

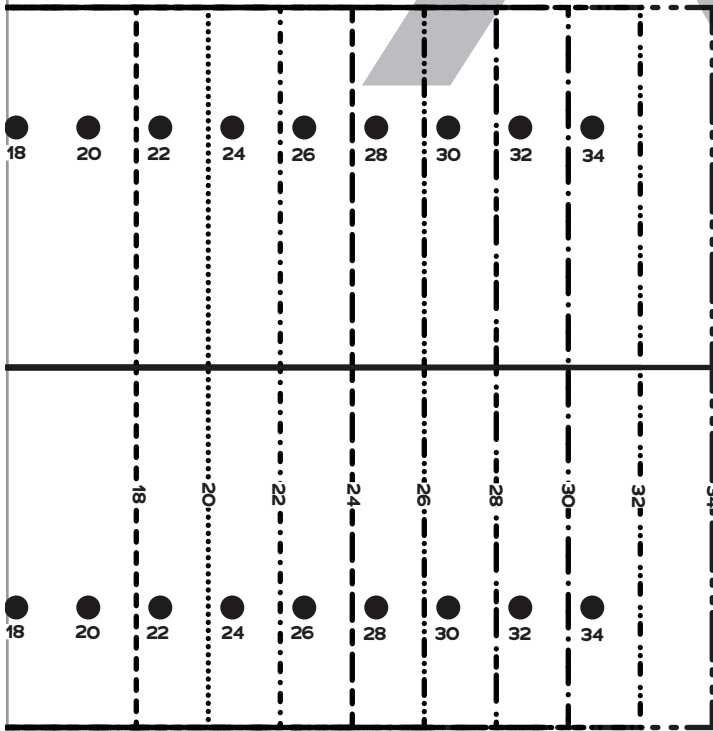

F4

F5

PAGE

77

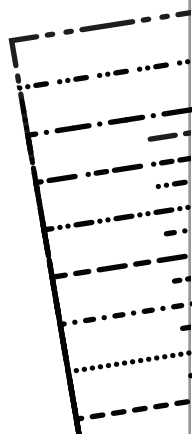

FOLD BACK THIS MARGIN

F5

F6

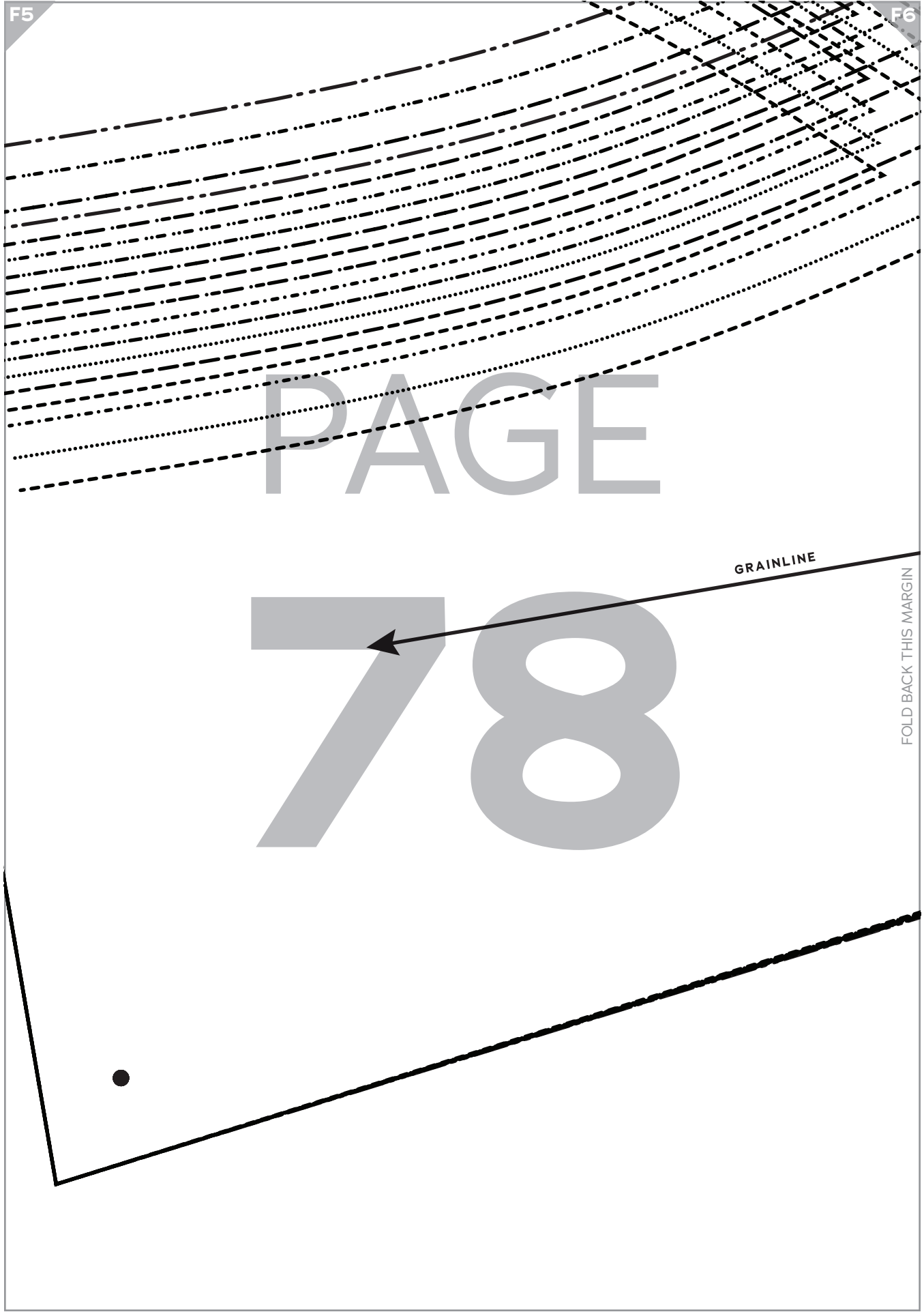

F6

F7

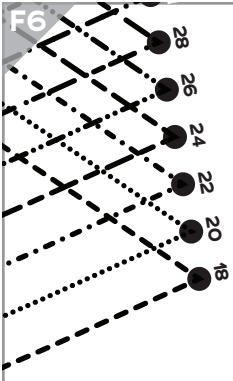

Corset Overlay  
Front, H Cup  
Cut 2 fabric

3

Society  
of CHARM  
*Aurora*  
BODICE  
SIZES 18-34

PAGE

79

FOLD BACK THIS MARGIN

F7

F8



PAGE

80

FOLD BACK THIS MARGIN



F8

F9

PAGE

81

FOLD BACK THIS MARGIN

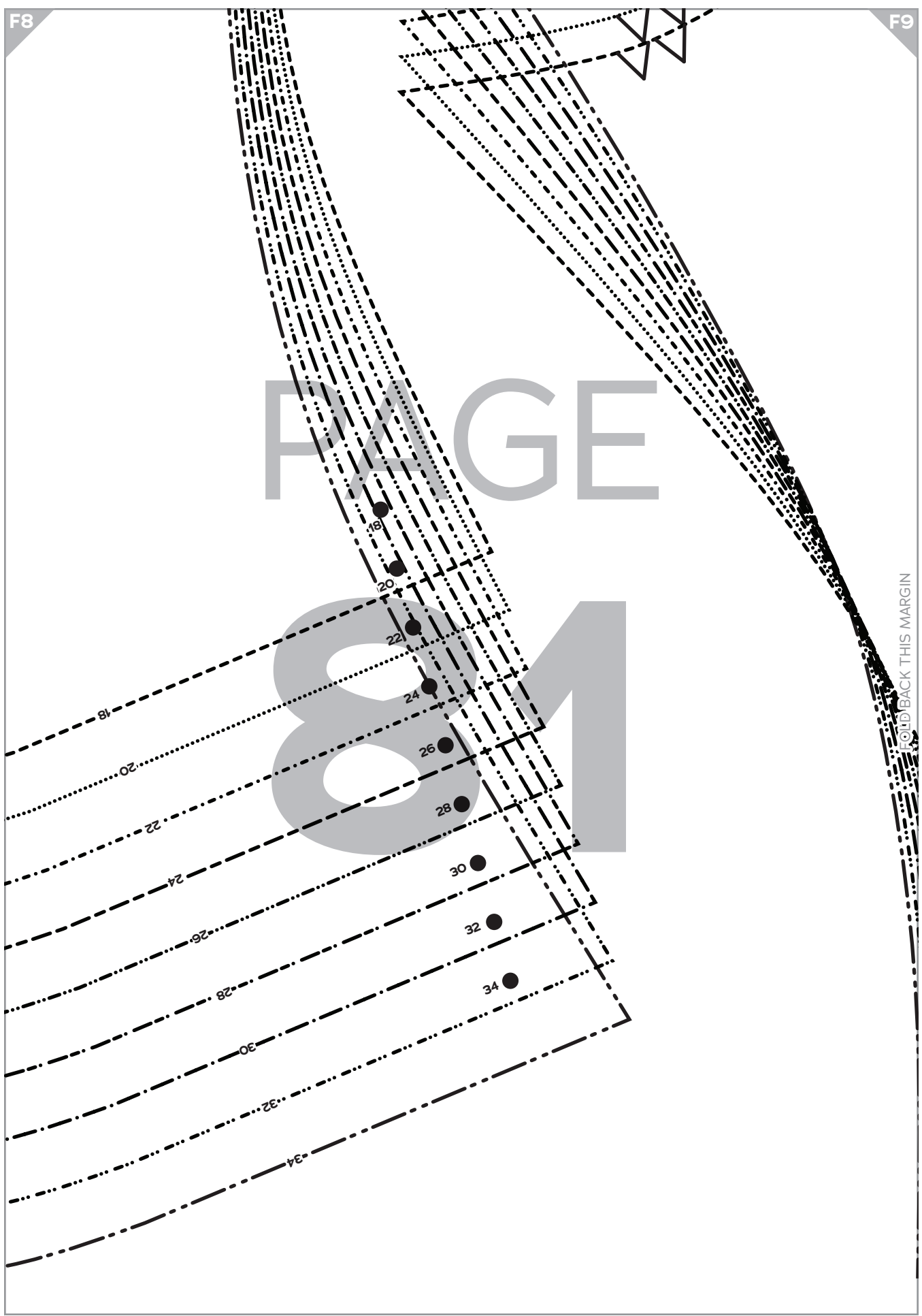

18 20 22 24 26 28 30 32 34

82

Society of Charm  
Aurora

BODICE  
SIZES 18-34

4

Corset  
Overlay Back  
Cut 2 fabric

FOLD BACK THIS MARGIN

34  
26  
18



F10

F11

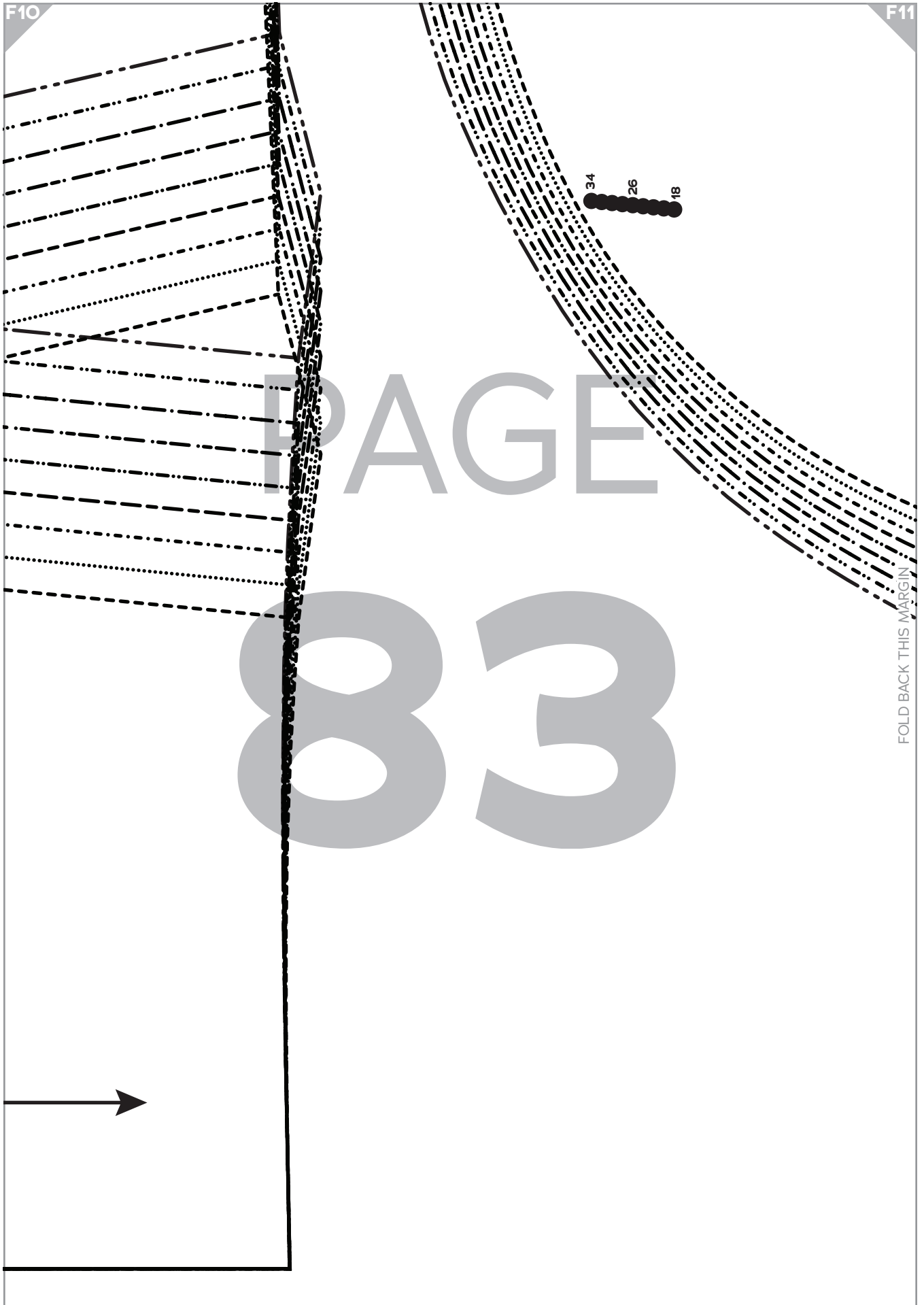

PAGE

84

