



CHARM SCHOOL UNIFORM

Sizes 2-20
with cup sizes A-H

5/8 inch (in) (1.5 cm) seam allowances are included on all pattern pieces.

**SIZE 2-20
PATTERN
SIZE KEY**

2	—————
4	- - - - -
6
8	- . - . -
10
12	- . - . -
14
16	- . - . -
18
20	- . - . -

SYMBOL KEY

grainline arrow



● match point/
placement mark



✕ button/buttonhole

☒ snap

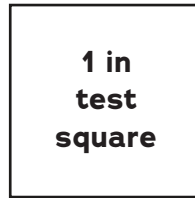
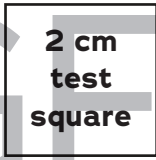

© 2024 Charm Patterns by Gertie
Distribution and Commercial Use Prohibited

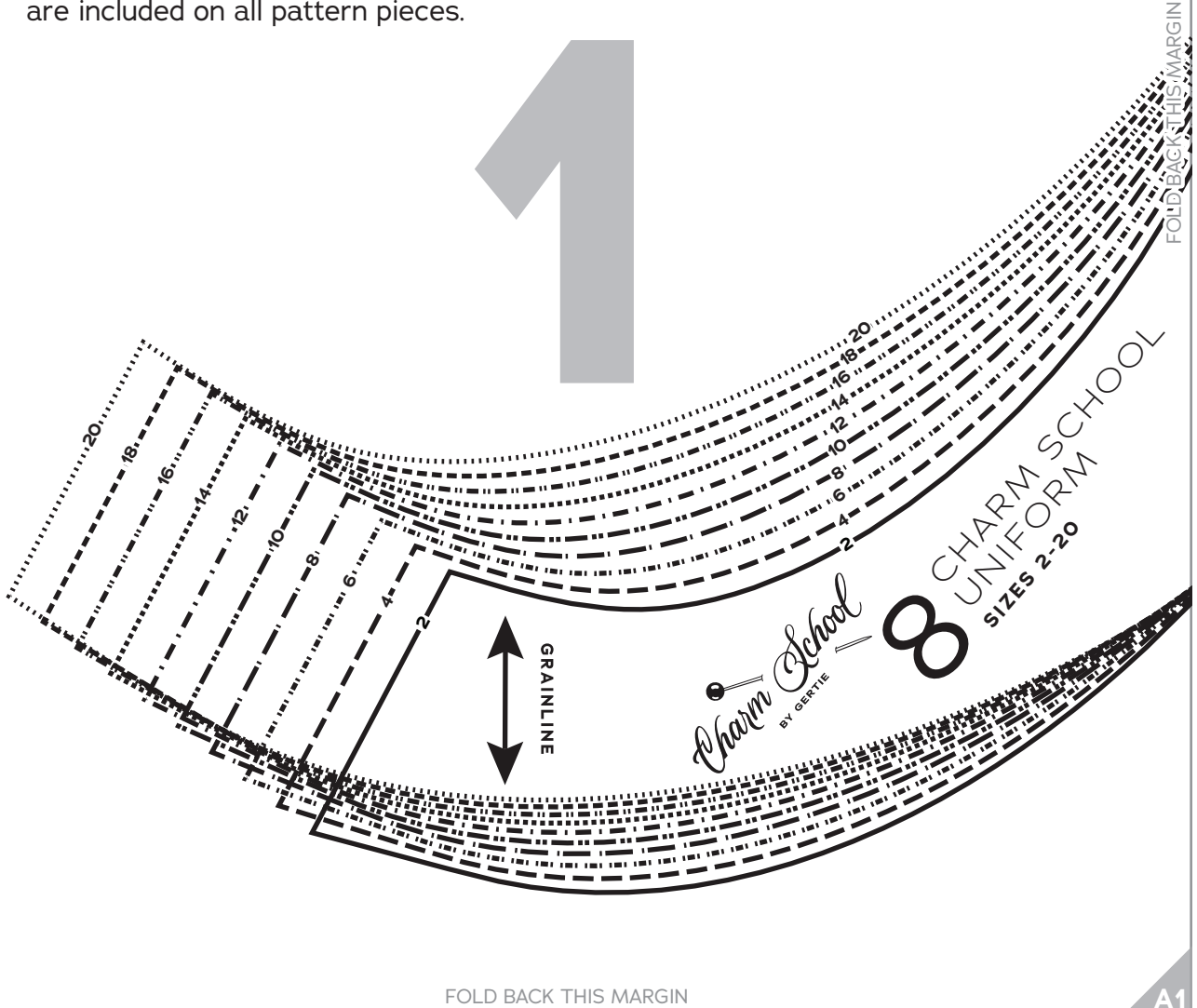

FOLD BACK THIS MARGIN

A1

PAGE

2

Skirt Pocket
Interfacing
Cut 2 interfacing

2
4
6
8
10
12
14
16
18
20

Charm School
BY GERTIE

11 CHARM SCHOOL
UNIFORM
SIZES 2-20

FOLD BACK THIS MARGIN

A1

FOLD BACK THIS MARGIN

A2

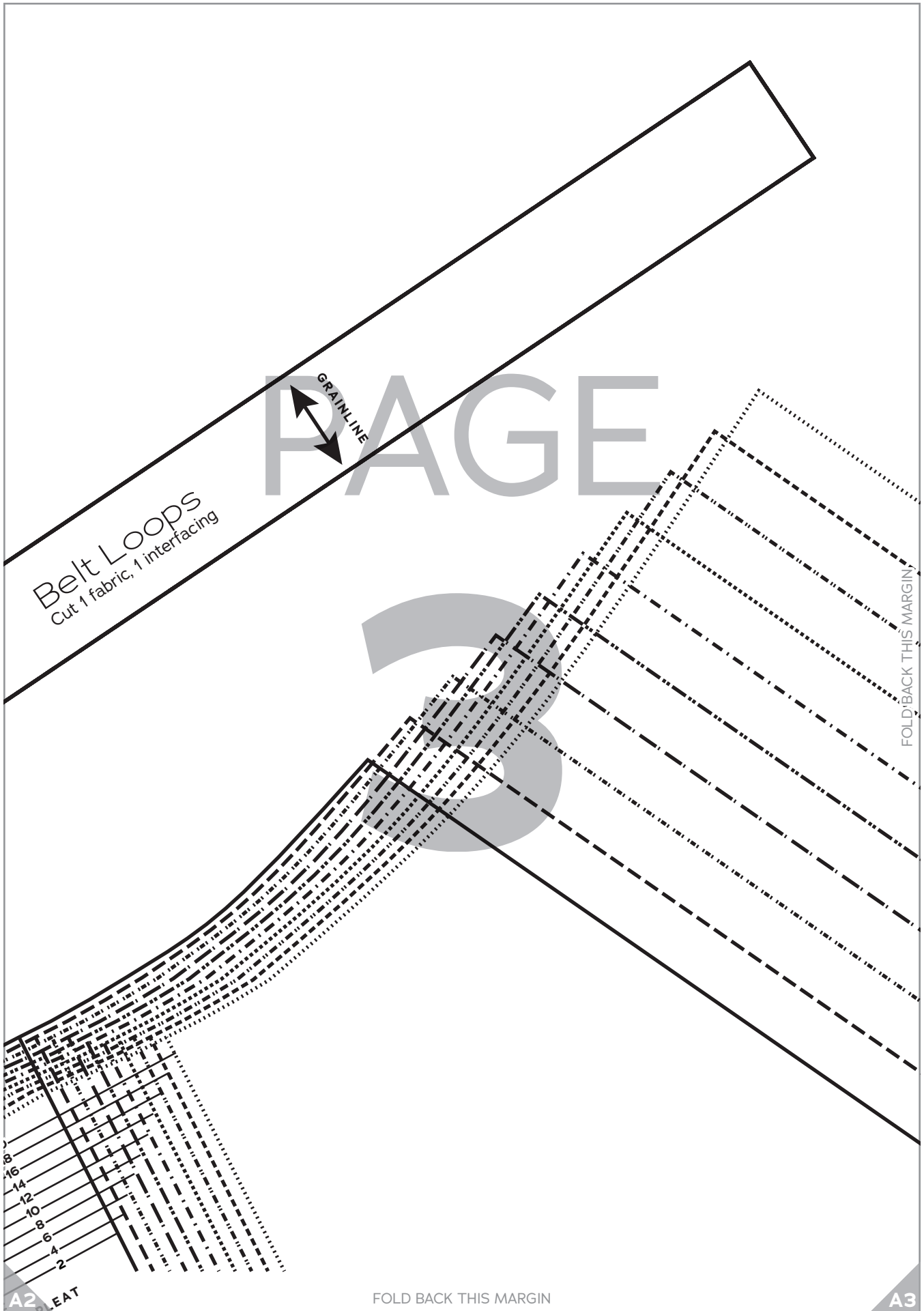

Belt Loops
Cut 1 fabric, 1 interfacing

PAGE

3

FOLD BACK THIS MARGIN

8
16
14
12
10
8
6
4
2
A2 EAT

FOLD BACK THIS MARGIN

A3

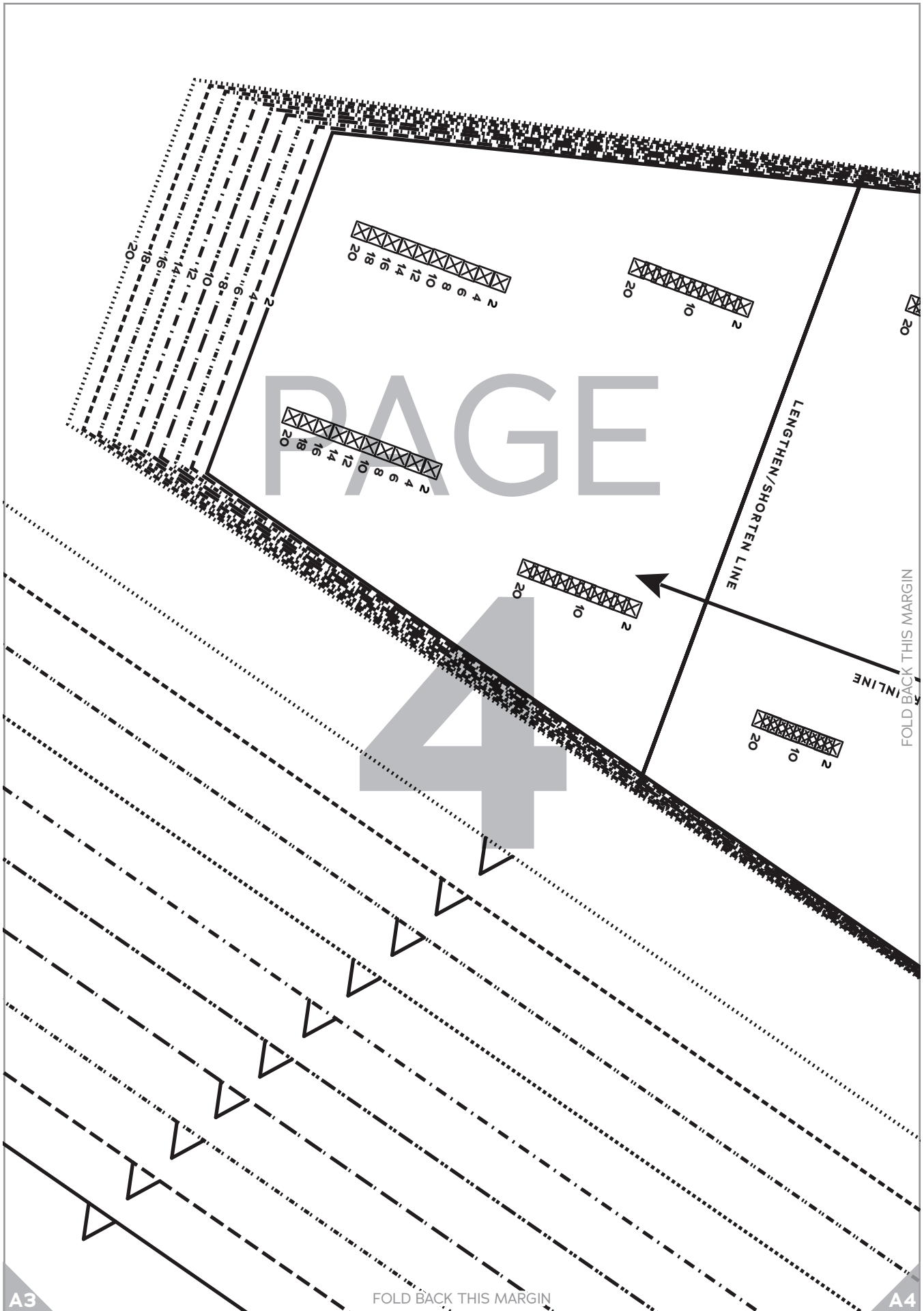

PAGE

4

A3

FOLD BACK THIS MARGIN

A4

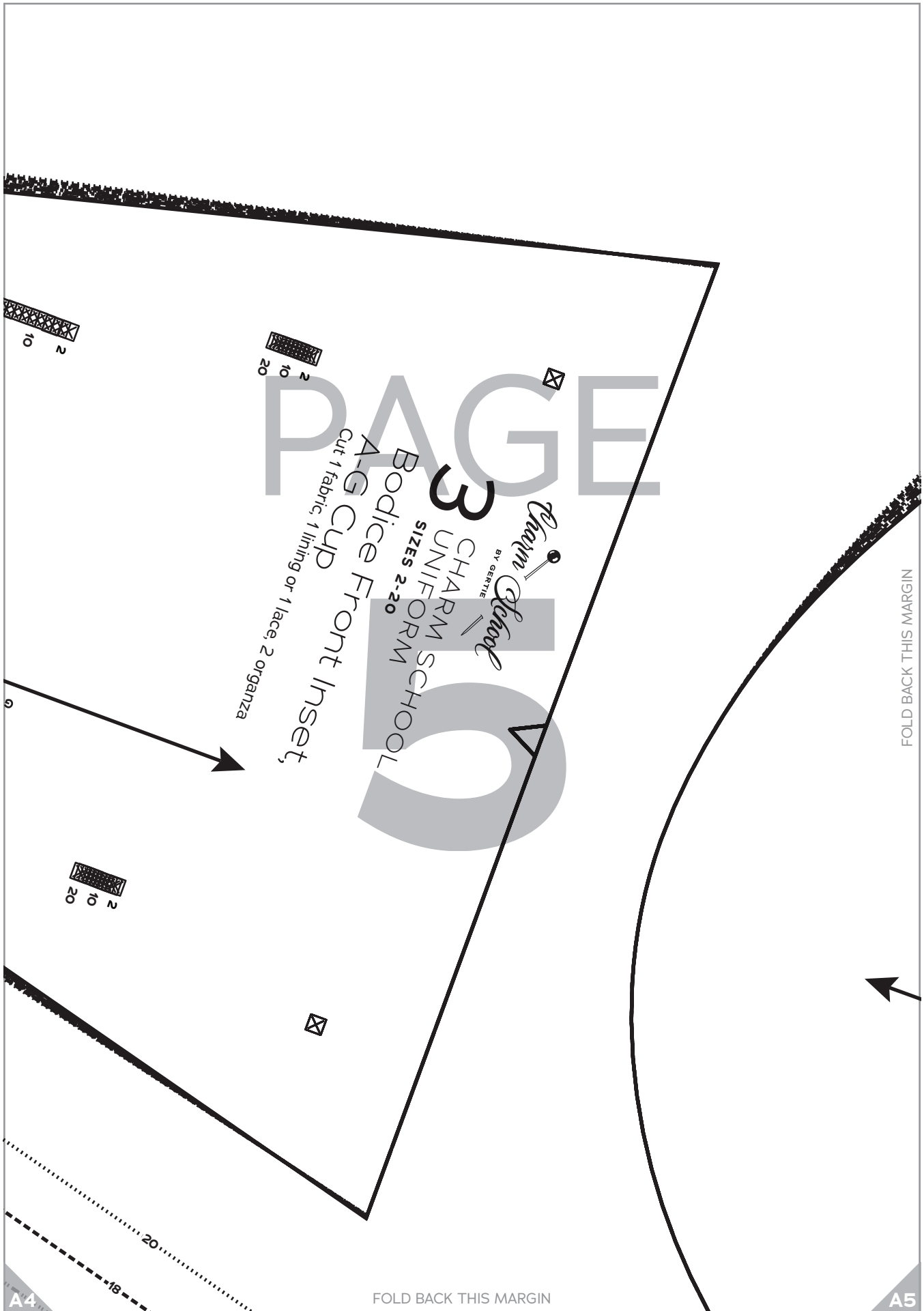

PAGE 3

Charm School
BY GERTIE
CHARM SCHOOL
UNIFORM
SIZES 2-20
Bodice Front Inset,
A-G CUP

Cut 1 fabric, 1 lining or 1 lace, 2 organza

FOLD BACK THIS MARGIN

FOLD BACK THIS MARGIN

A4

A5

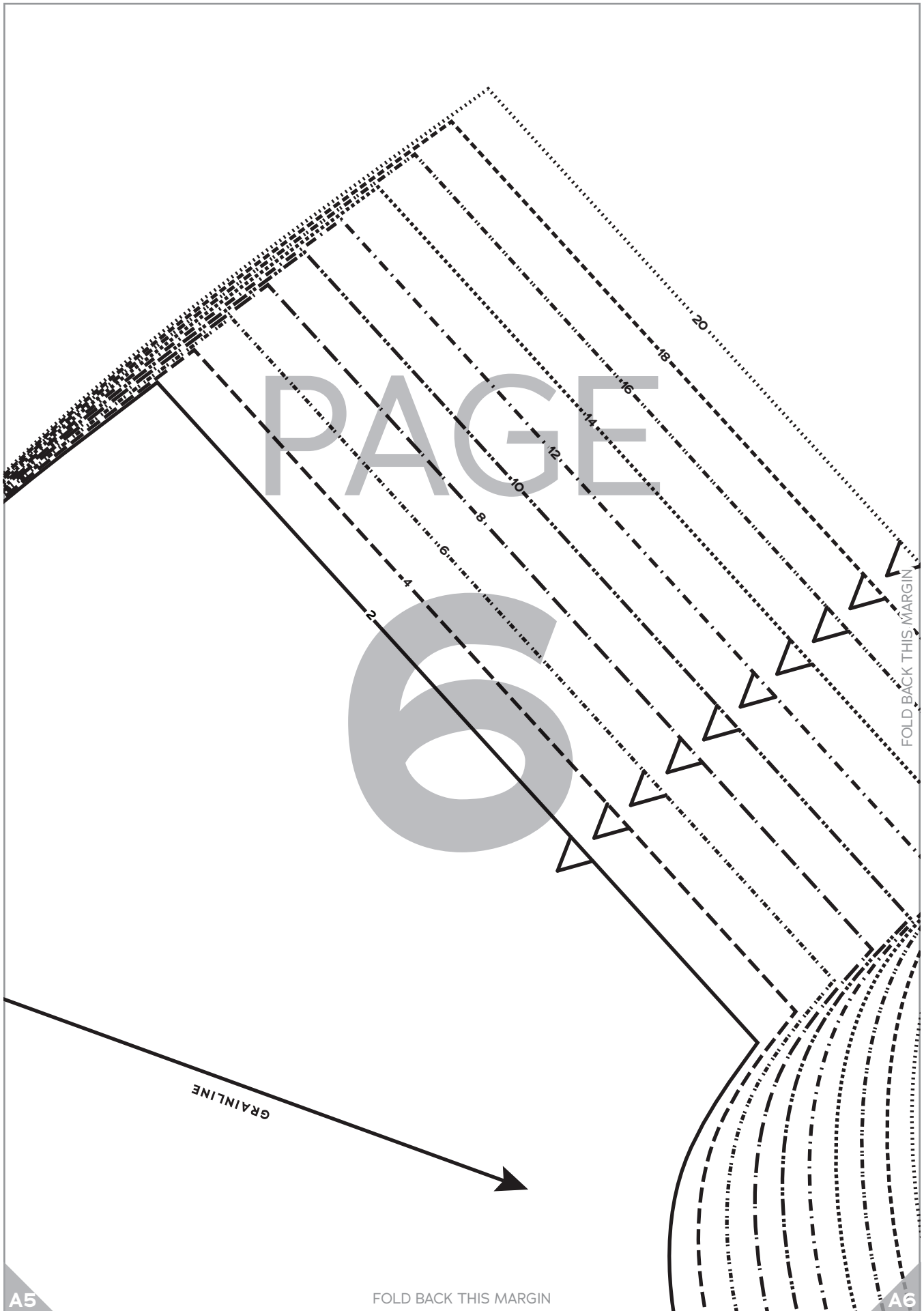

PAGE

GRAINLINE

Charm School
BY GERTIE

CHARM SCHOOL
UNIFORM
SIZES 2-20

3

Front Inset,

Bodice

H Cup

cut 1 fabric, 1 lining or 1 lace, 2 organza

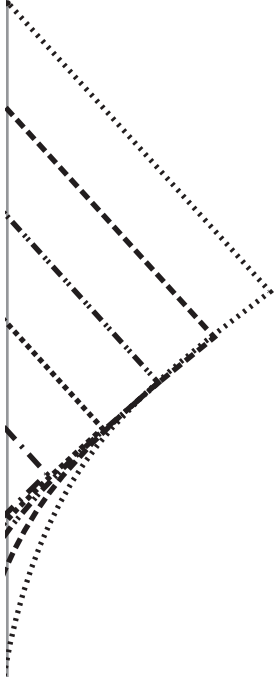

A6

FOLD BACK THIS MARGIN

A7

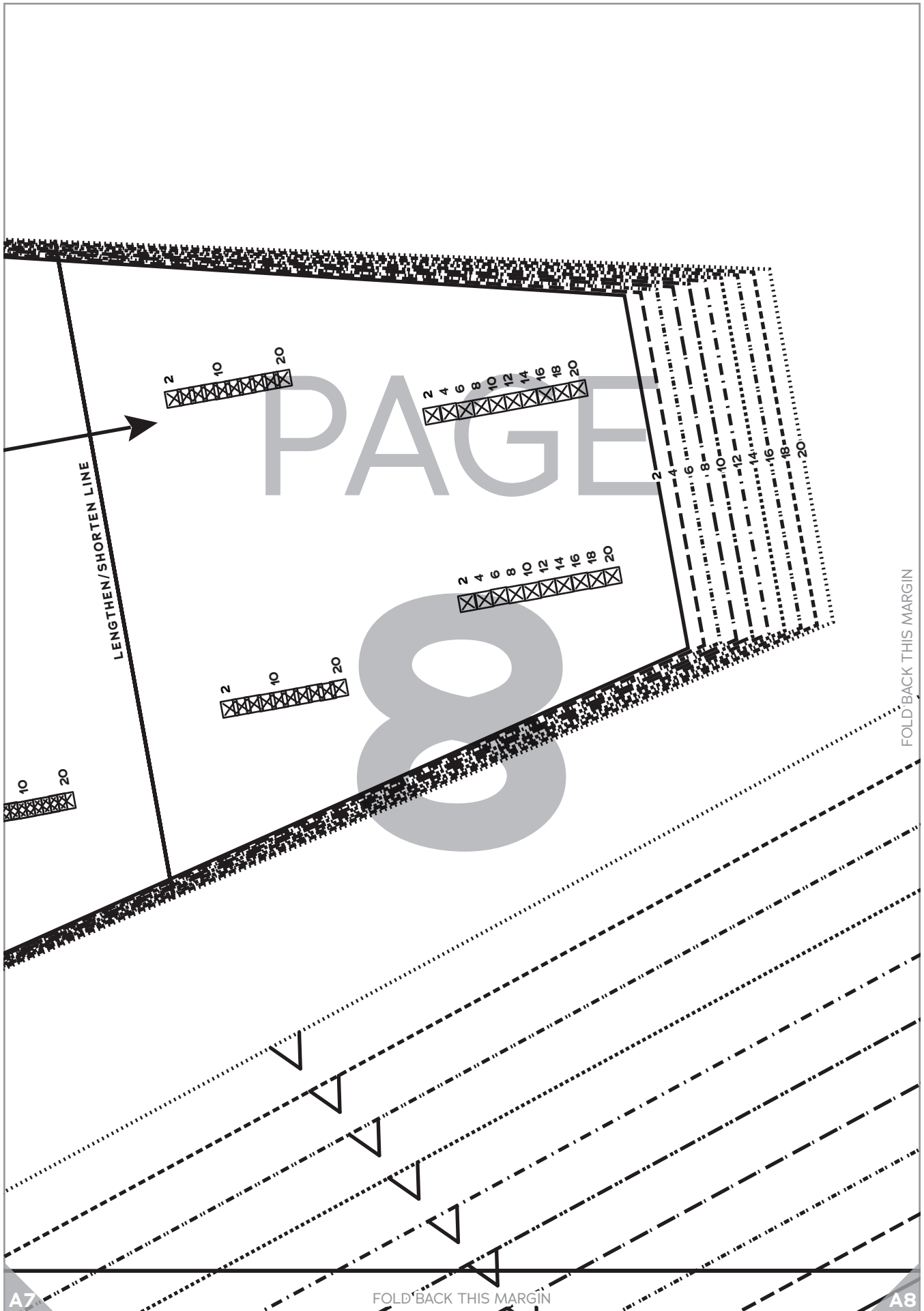

PAGE

9

FOLD BACK THIS MARGIN

A8

FOLD BACK THIS MARGIN

A9

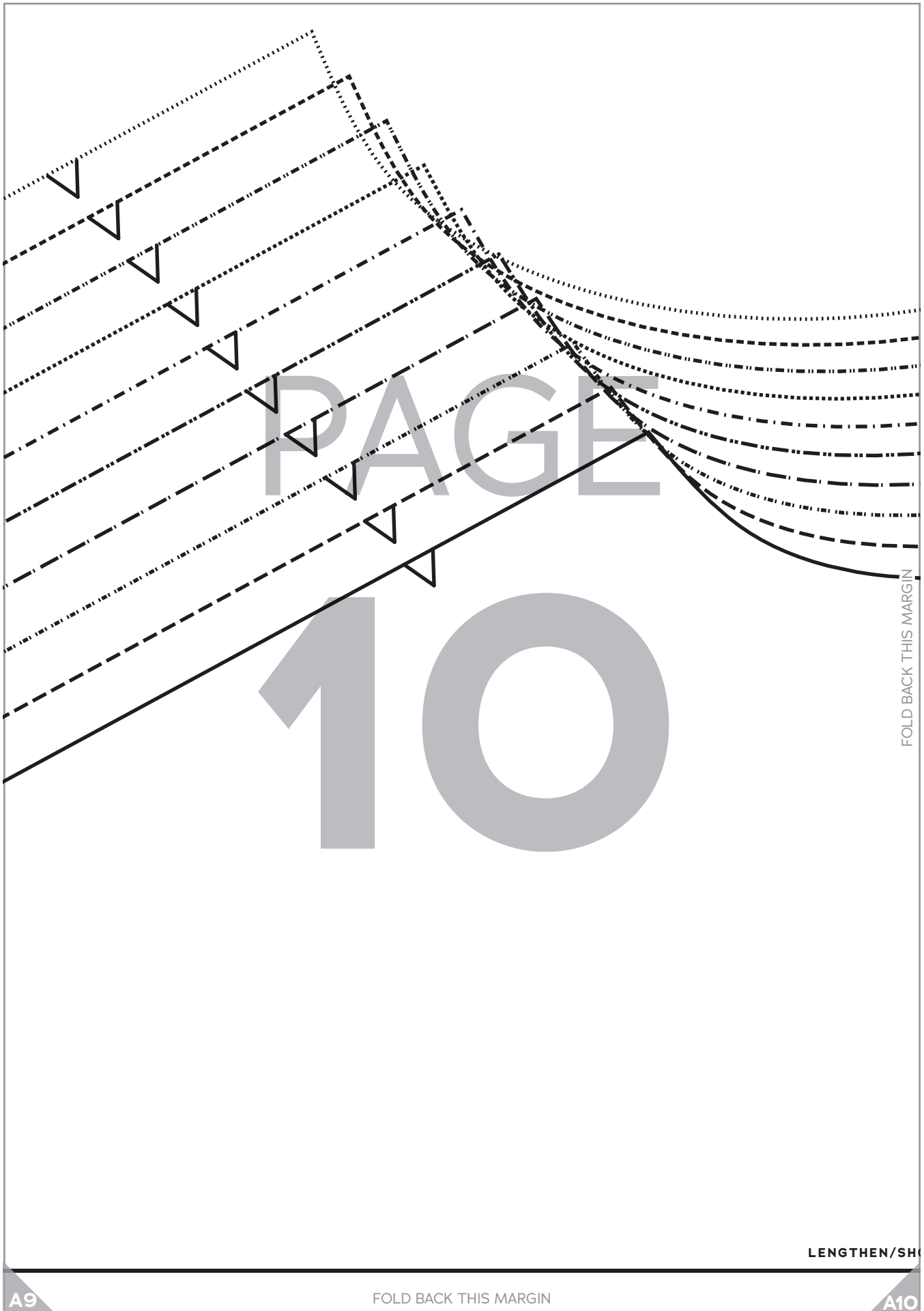

PAGE

10

FOLD BACK THIS MARGIN

LENGTHEN/SH

A9

FOLD BACK THIS MARGIN

A10

PAGE

11

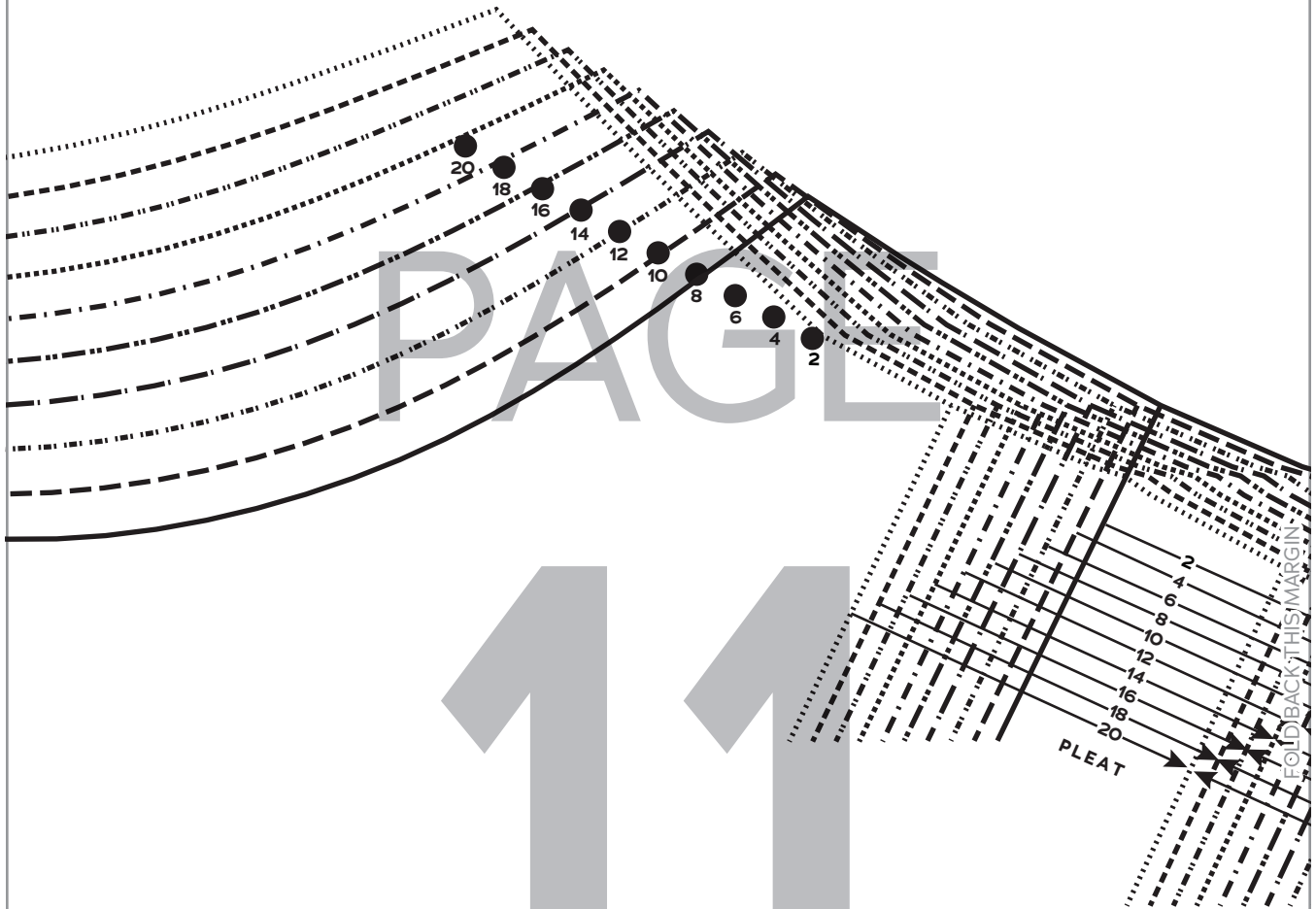

ORTEN LINE

A10

FOLD BACK THIS MARGIN

A11

PAGE

12

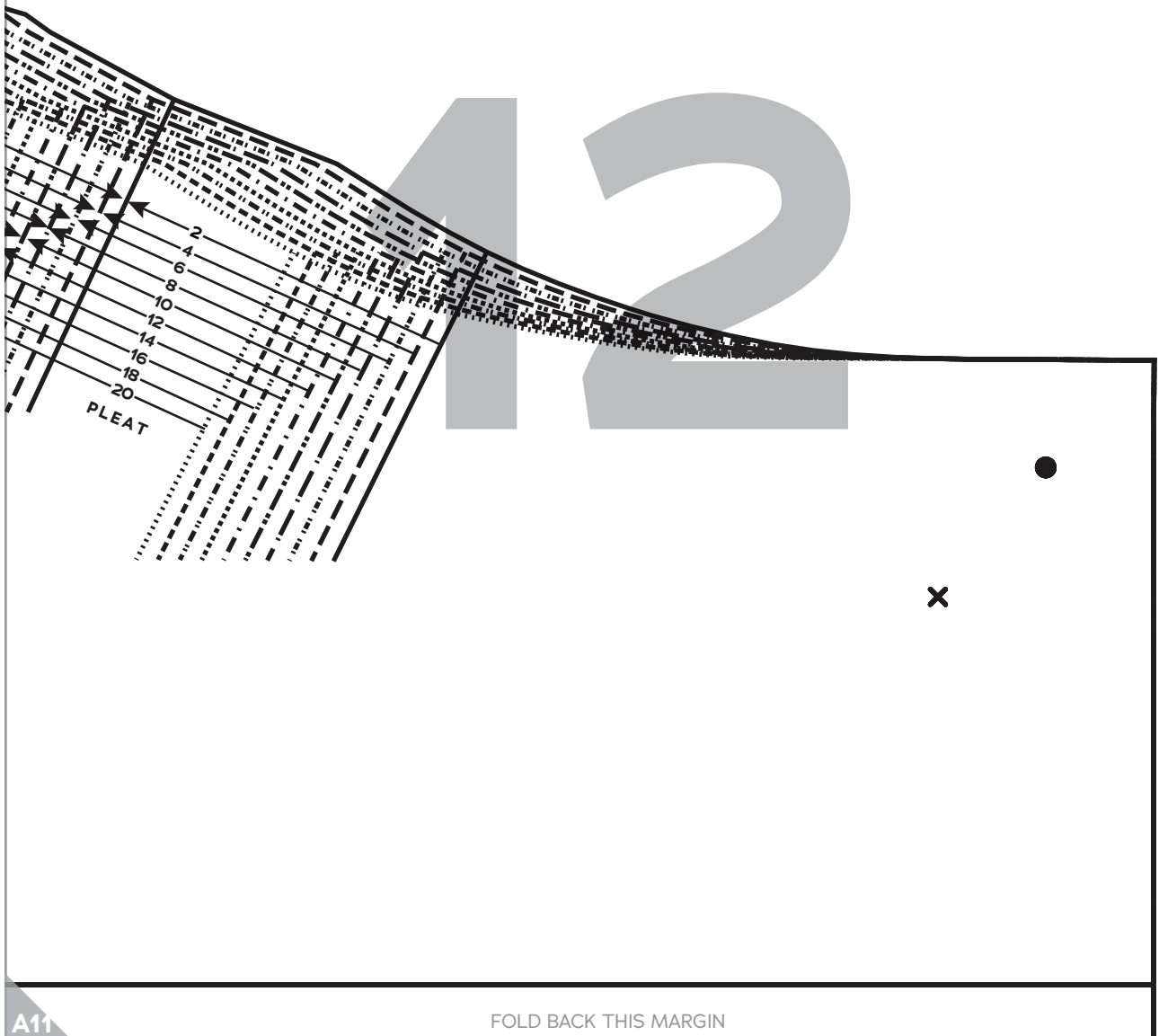

A11

FOLD BACK THIS MARGIN

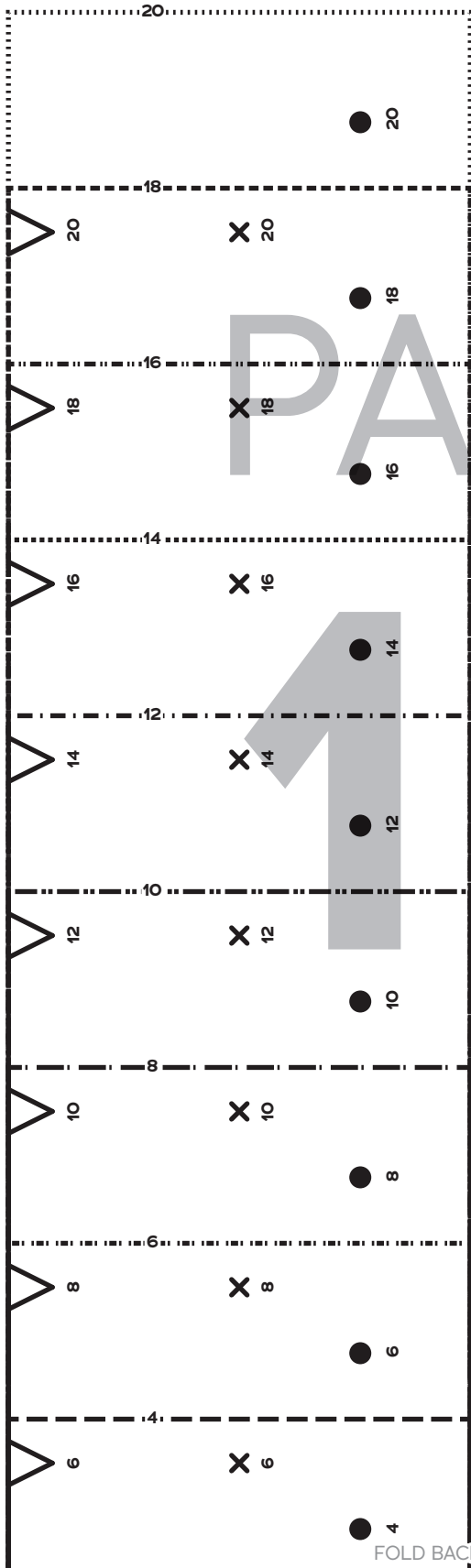

FOLD BACK THIS MARGIN

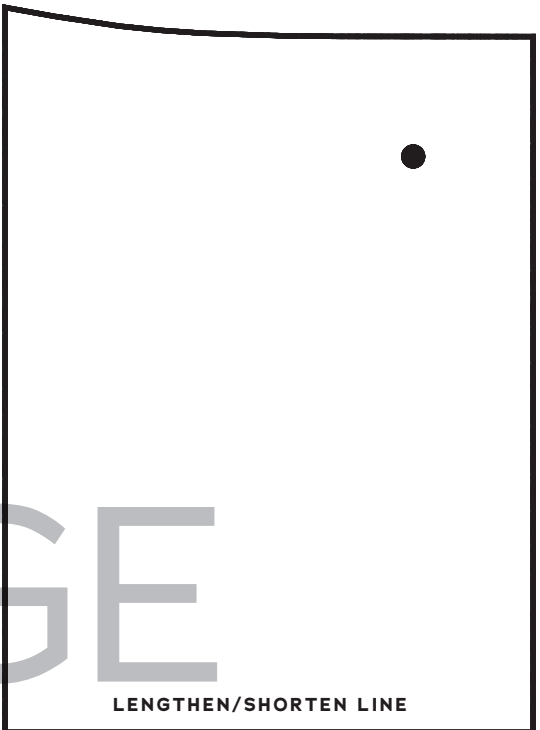

LENGTHEN/SHORTEN LINE



9 CHARM SCHOOL
UNIFORM
SIZES 2-20

Skirt Front
Facing

Cut 2 fabric, 2 interfacing

FOLD BACK THIS MARGIN

A1

A2

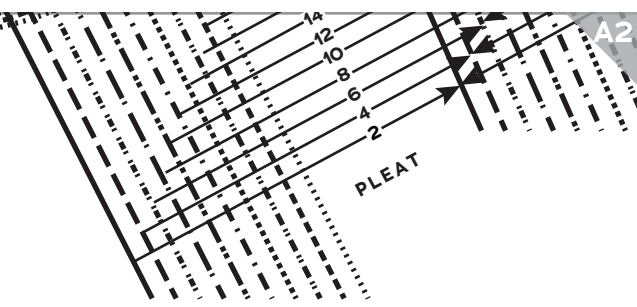

PAGE

14



FOLD BACK THIS MARGIN

FOLD BACK THIS MARGIN

B1

B2

A2

A3

PAGE

LENGTHEN/SHORTEN

15

FOLD BACK THIS MARGIN

Charm School
BY GERTIE

5 CHARM SCHOOL
UNIFORM
SIZES 2-20

Skirt Back
Cut 1 fabric on fold

B2

FOLD BACK THIS MARGIN

B3

A3

A4

PAGE

CUT ALONG THIS LINE

16

FOLD BACK THIS MARGIN

B3

FOLD BACK THIS MARGIN

B4

A4

A5

2

16

14

PAGE

17

FOLD BACK THIS MARGIN

B4

FOLD BACK THIS MARGIN

B5

A5

A6



 Charm School

 BY GERTIE

 CHARM SCHOOL

 UNIFORM

 SIZES 2-20

 Skirt Pocket Bag

 Cut 2 fabric or lining

PAGE

18

FOLD BACK THIS MARGIN

B5

FOLD BACK THIS MARGIN

B6

A6

A7

PAGE
19

2
10
20

FOLD BACK THIS MARGIN

FOLD BACK THIS MARGIN

B6

B7

A7

A8

PAGE

20

FOLD BACK THIS MARGIN

B7

FOLD BACK THIS MARGIN

B8

A8

A9

PAGE

21

FOLD BACK THIS MARGIN

B8

FOLD BACK THIS MARGIN

B9

A9

A10



4 CHARM SCHOOL
UNIFORM
SIZES 2-20

Skirt Front
Cut 2 fabric

PAGE

22

FOLD BACK THIS MARGIN

B9

FOLD BACK THIS MARGIN

B10

A10

A11

PAGE 23

GRAINLINE

FOLD BACK THIS MARGIN

B10

FOLD BACK THIS MARGIN

B11

A11

x

PAGE

x

24

x

B11

FOLD BACK THIS MARGIN

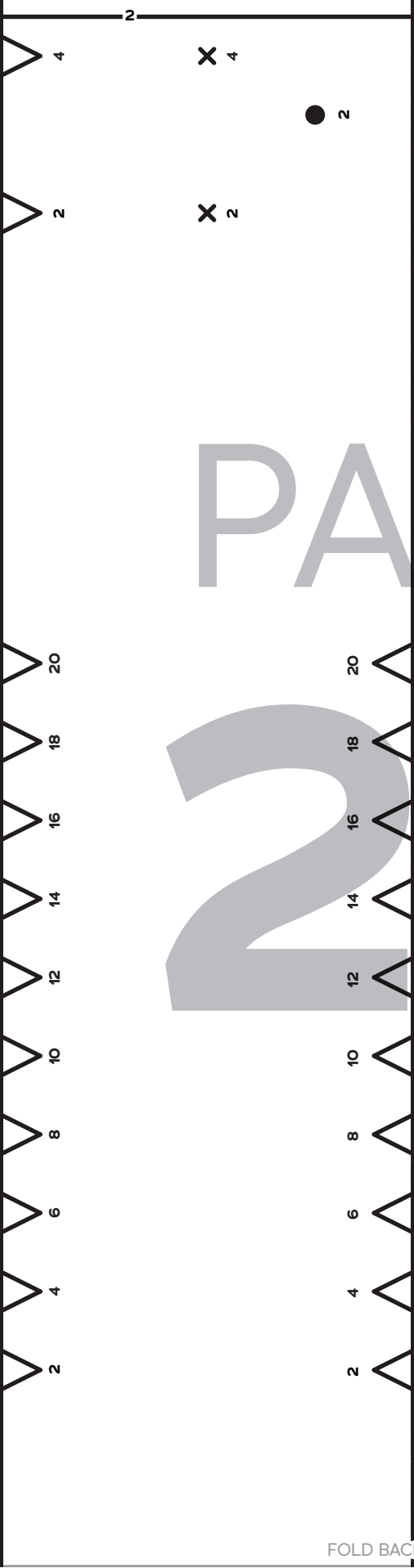

PAGE

25

GRAINLINE

FOLD BACK THIS MARGIN

FOLD BACK THIS MARGIN

B1

B2

FOLD

PAGE

26

FOLD BACK THIS MARGIN

C1

FOLD BACK THIS MARGIN

C2

B2

B3

PAGE

27

FOLD BACK THIS MARGIN

C2

FOLD BACK THIS MARGIN

C3

B3

B4

PAGE

28

FOLD BACK THIS MARGIN

C3

FOLD BACK THIS MARGIN

C4

B4

B5

PAGE

29

FOLD BACK THIS MARGIN

C4

FOLD BACK THIS MARGIN

C5

B5

B6

PAGE

30

2
4
6
8
10
12
14
16
18
20

FOLD BACK THIS MARGIN

C5

FOLD BACK THIS MARGIN

C6

B6

B7

PAGE

31



 CHARM SCHOOL
 BY GERTIE
 CHARM
 UNIFORM
 SIZES 2-20
 6
 Side Front
 Skirt
 Cut 2 fabric

FOLD BACK THIS MARGIN

C6

FOLD BACK THIS MARGIN

C7

B7

B8

PAGE

32

FOLD BACK THIS MARGIN

GRAINLINE

FOLD BACK THIS MARGIN

C7

C8

B8

B9

PAGE

33

FOLD BACK THIS MARGIN

C8

FOLD BACK THIS MARGIN

C9

B9

B10

PAGE

34

FOLD BACK THIS MARGIN

C9

FOLD BACK THIS MARGIN

C10

B10

B11

PAGE
35

FOLD BACK THIS MARGIN

C10

FOLD BACK THIS MARGIN

C11



PAGE



36





CHARM SCHOOL
UNIFORM
SIZES 2-20

Waistband
Cut 2 fabric, 1 interfacing

PAGE

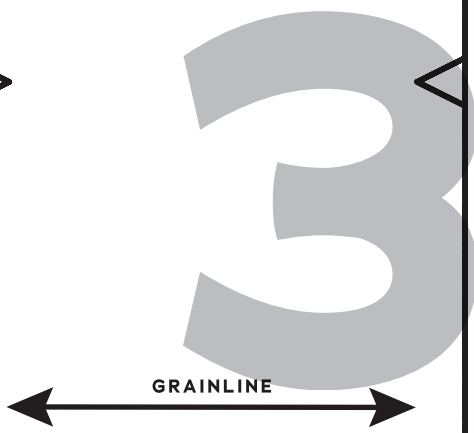

FOLD BACK THIS MARGIN

FOLD BACK THIS MARGIN

C1

C2

PAGE

38



FOLD BACK THIS MARGIN

D1

FOLD BACK THIS MARGIN

D2

C2

C3

PAGE 39

FOLD BACK THIS MARGIN

D2

FOLD BACK THIS MARGIN

D3

C3

C4

PAGE

40

FOLD BACK THIS MARGIN

D3

FOLD BACK THIS MARGIN

D4

C4

C5

PAGE

44

FOLD BACK THIS MARGIN

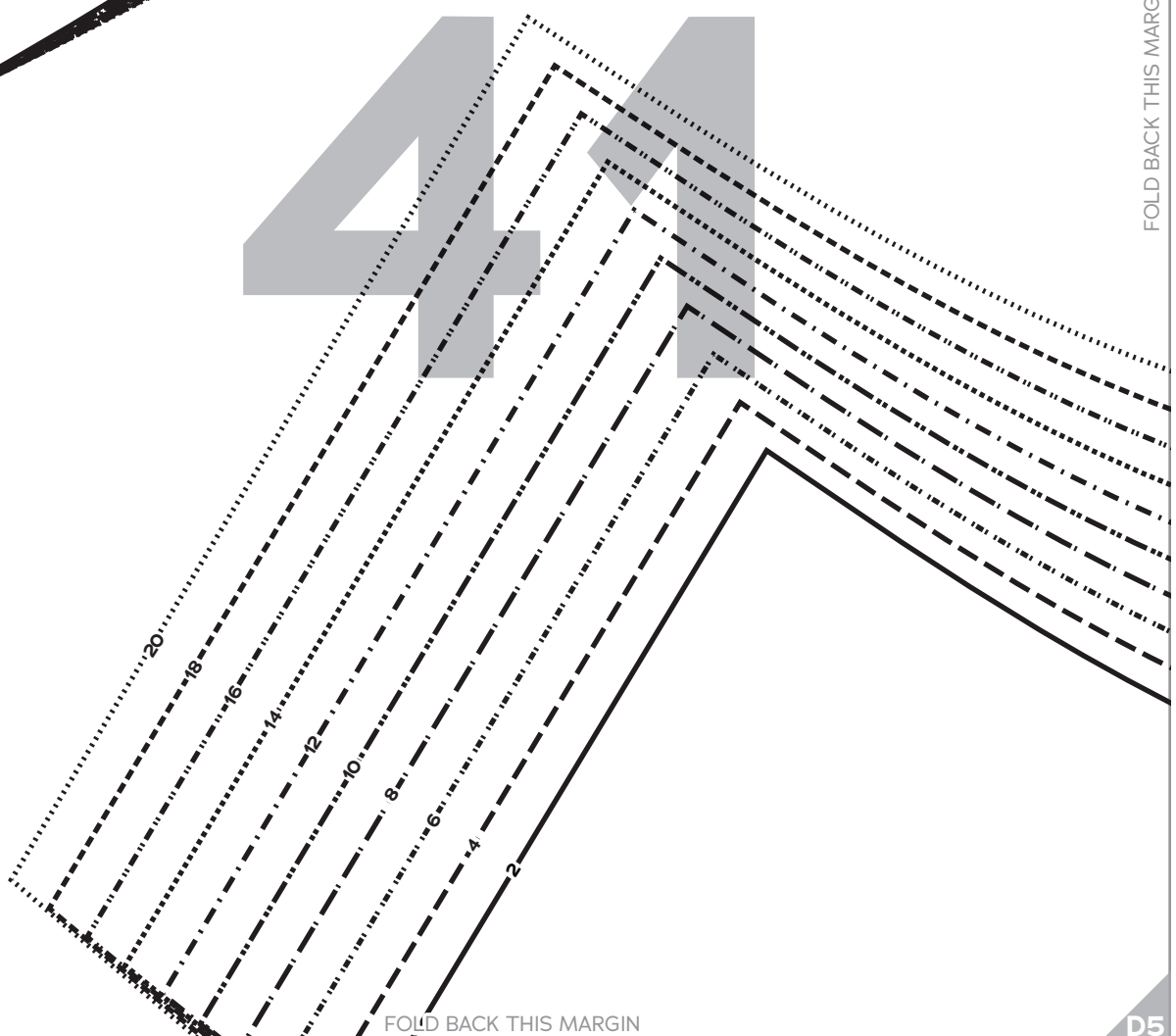

D4

FOLD BACK THIS MARGIN

D5

C5

C6

PAGE

42

FOLD BACK THIS MARGIN

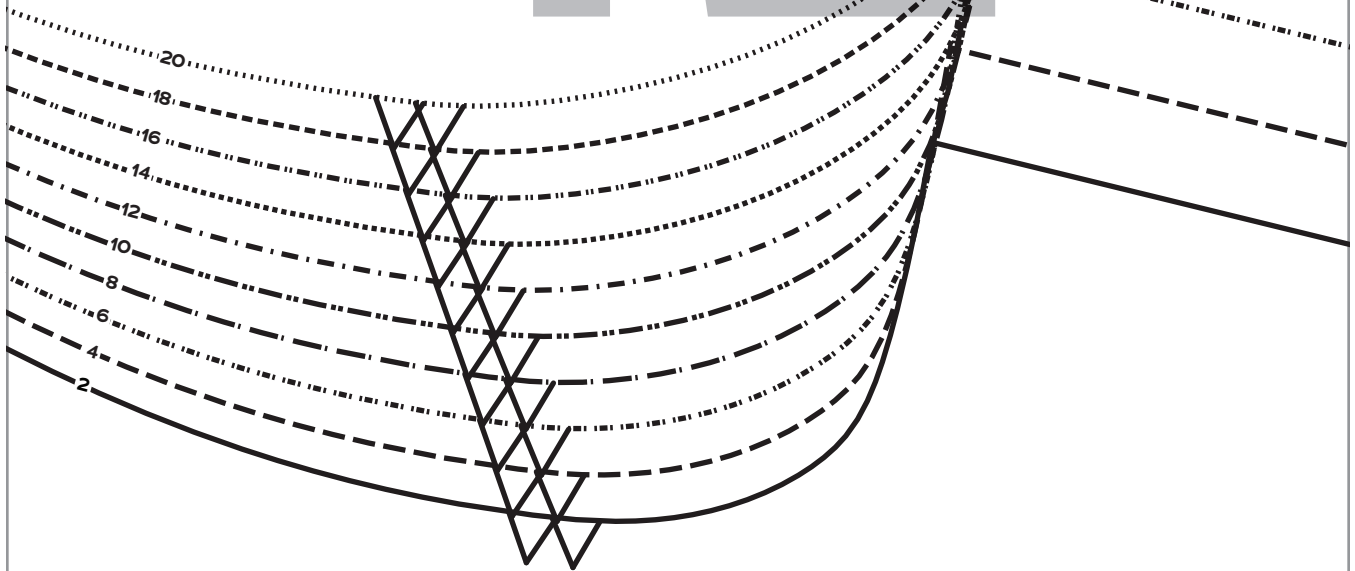

D5

FOLD BACK THIS MARGIN

D6

C6

C7

PAGE

43

FOLD BACK THIS MARGIN

SHORTEN LINE

FOLD BACK THIS MARGIN

D6

D7

C7

C8

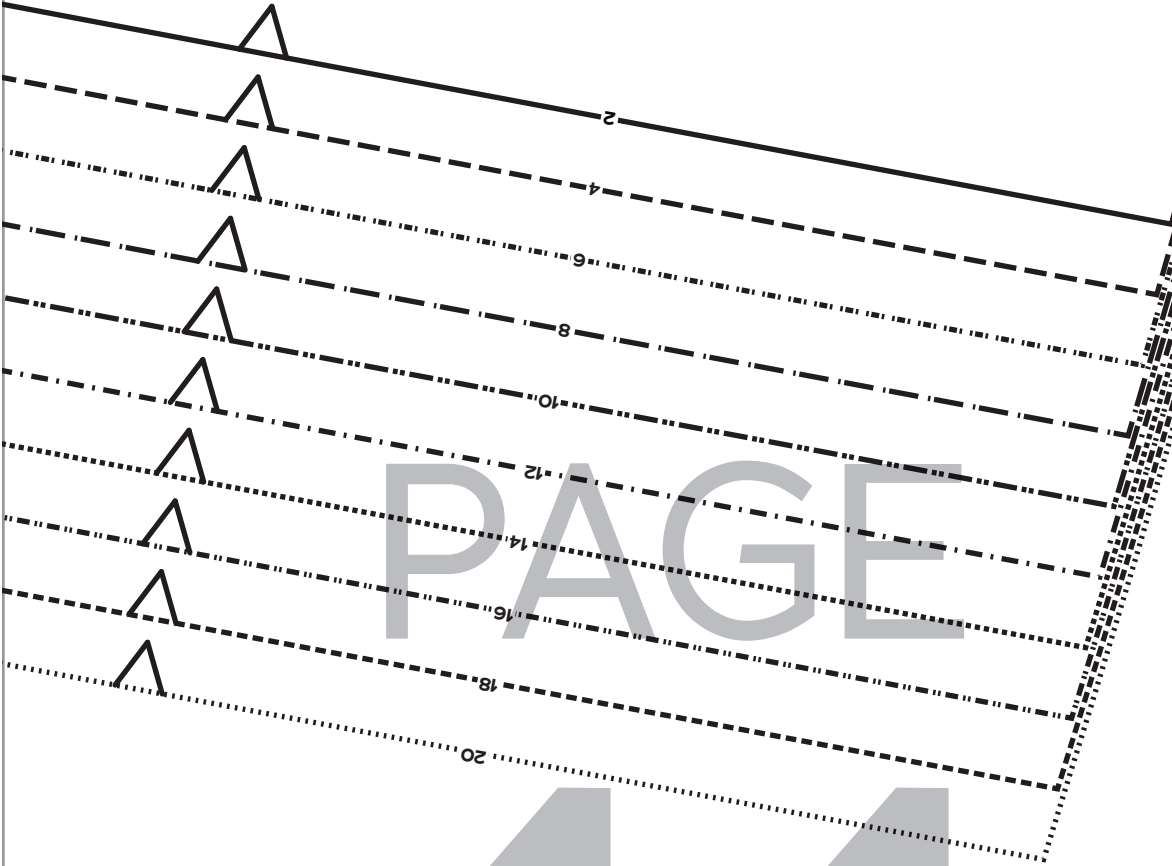

PAGE

44

FOLD BACK THIS MARGIN

D7

FOLD BACK THIS MARGIN

D8

C8

C9

PAGE

45

20
18
16
14
12
10
8
6
4
2

FOLD BACK THIS MARGIN

D8

FOLD BACK THIS MARGIN

D9

C9

C10

PAGE 405

FOLD BACK THIS MARGIN



BY GERTIE
CHARM SCHOOL
UNIFORM
SIZES 2-20
Bodice Front,
B/C Cup
cut 2 fabric, 2 lining



20
18
16
14
12
10
8
6
4
2



GRAIN LINE

D9

FOLD BACK THIS MARGIN

D10

PAGE

47

FOLD BACK THIS MARGIN

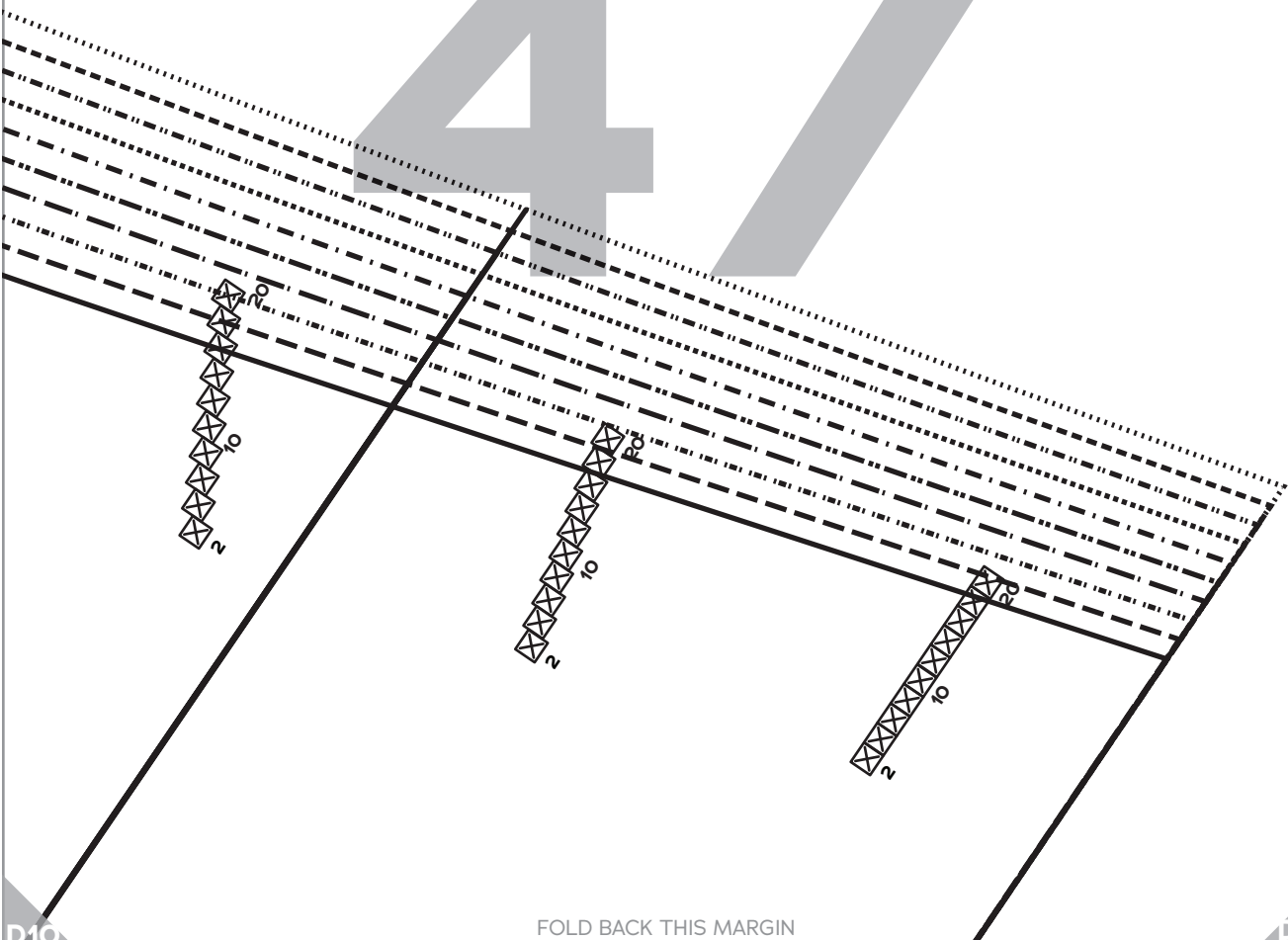

PAGE

48



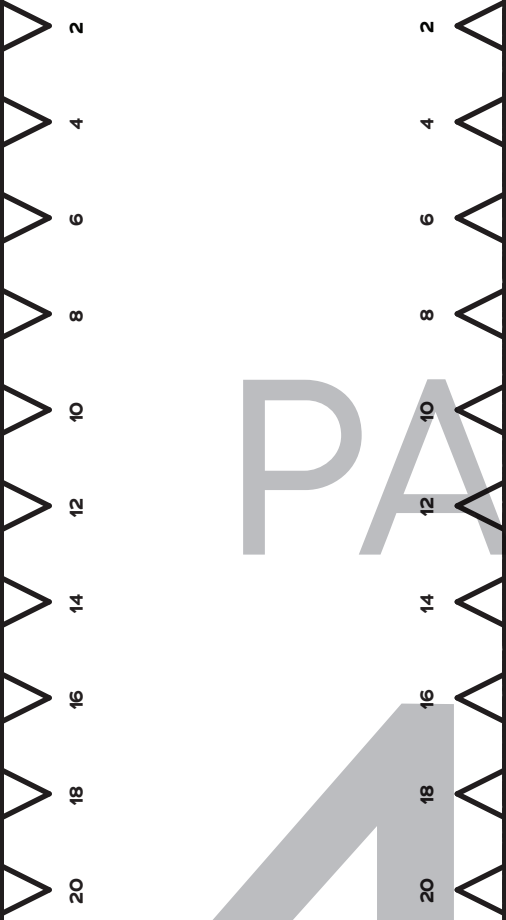

PAGE 4

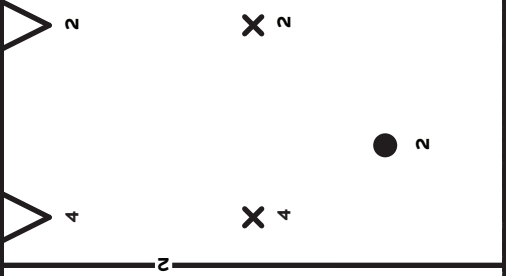

FOLD BACK THIS MARGIN

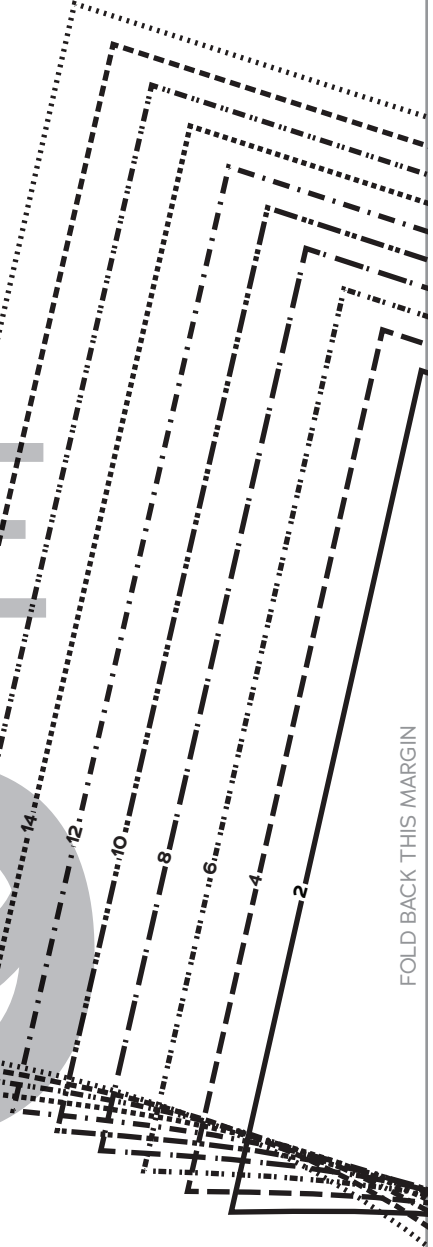

FOLD BACK THIS MARGIN

D1

D2

PAGE

50

Charm School
BY GERTIE

CHARM SCHOOL
UNIFORM
SIZES 2-20

Bodice Front,
A Cup
Cut 2 fabric, 2 lining

FOLD BACK THIS MARGIN

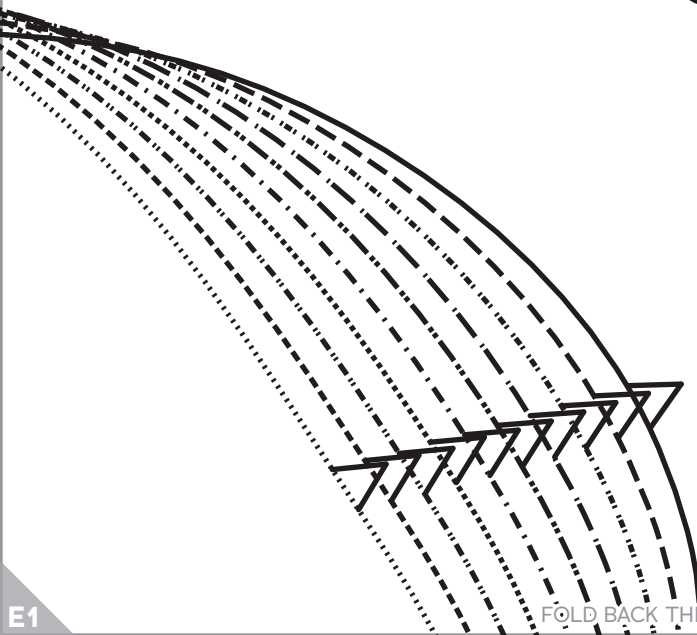

FOLD BACK THIS MARGIN

E1

E2

D2

D3

PAGE

54

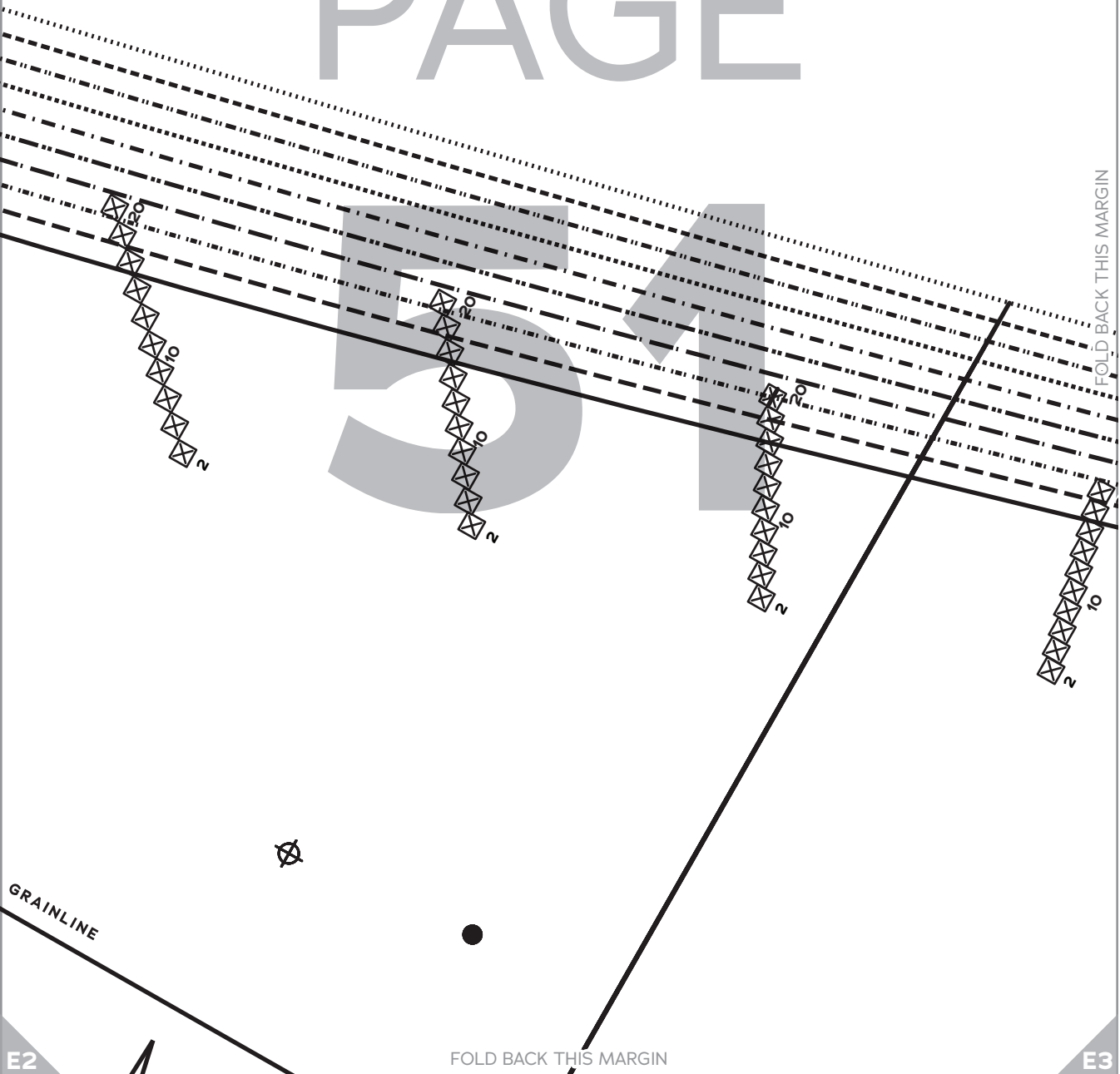

GRAINLINE

E2

FOLD BACK THIS MARGIN

E3

D3

D4

PAGE

52

FOLD BACK THIS MARGIN

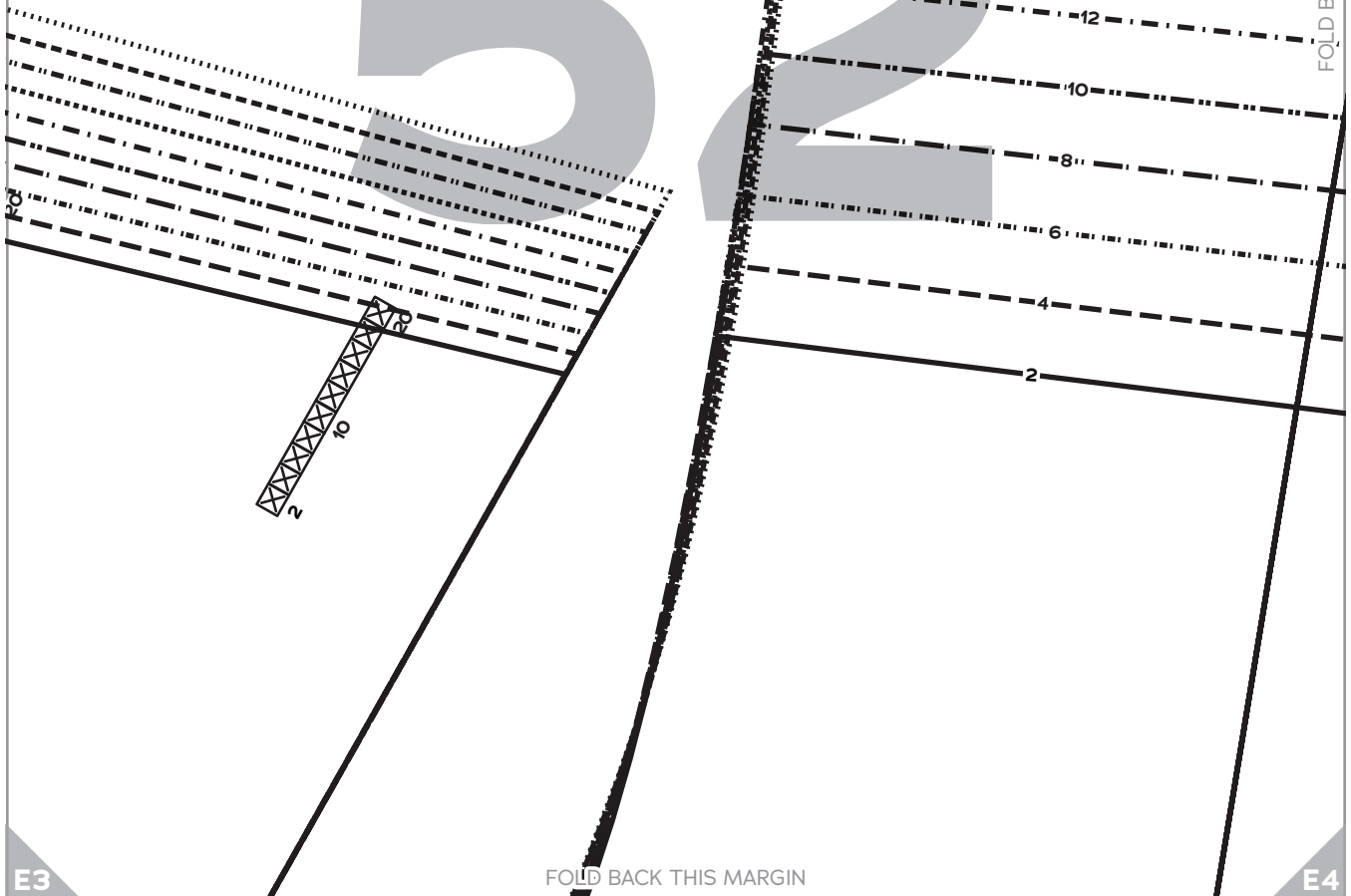

E3

FOLD BACK THIS MARGIN

E4

D4

D5

PAGE

53

FOLD BACK THIS MARGIN

E4

FOLD BACK THIS MARGIN

E5

D5

D6

Charm School
 BY GERTIE
 CHARM SCHOOL
 UNIFORM
 SIZES 2-20

Bodice Back
 Cut: 1 fabric on fold, 1 lining on fold

PAGE

54

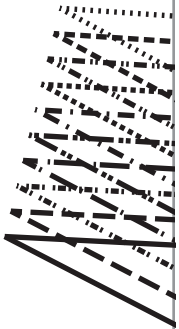

FOLD BACK THIS MARGIN

FOLD

E5

FOLD BACK THIS MARGIN

E6

D6

D7

LENGTHEN

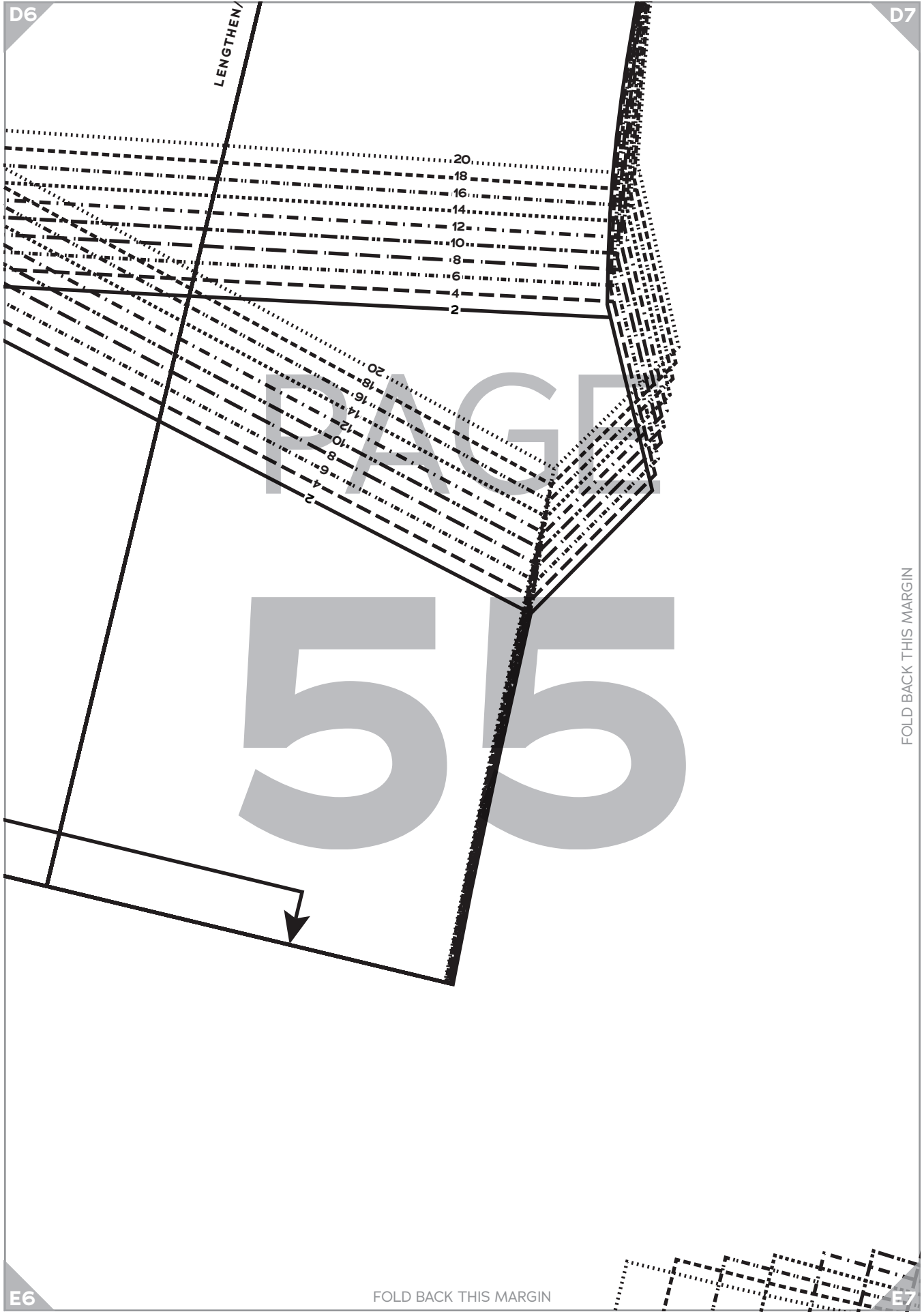

FOLD BACK THIS MARGIN

FOLD BACK THIS MARGIN

E6

E7

D7

D8

PAGE
56

FOLD BACK THIS MARGIN

E7

FOLD BACK THIS MARGIN

E8

D8

D9

PAGE
57

FOLD BACK THIS MARGIN



2
4
6
8
10
12
14
16
18
20

FOLD BACK THIS MARGIN

E8

E9

D9

D10

PAGE

58

LENGTHEN/SHORTEN LINE

FOLD BACK THIS MARGIN

E9

FOLD BACK THIS MARGIN

E10

D10

D11

PAGE

59

FOLD BACK THIS MARGIN

FOLD BACK THIS MARGIN

E10

E11

D11

PAGE

60

Charm School
BY GERTIE

1 CHARM SCHOOL
UNIFORM
SIZES 2-20

Bodice Front,
H Cup
Cut 2 fabric, 2 lining

FOLD BACK THIS MARGIN

E11

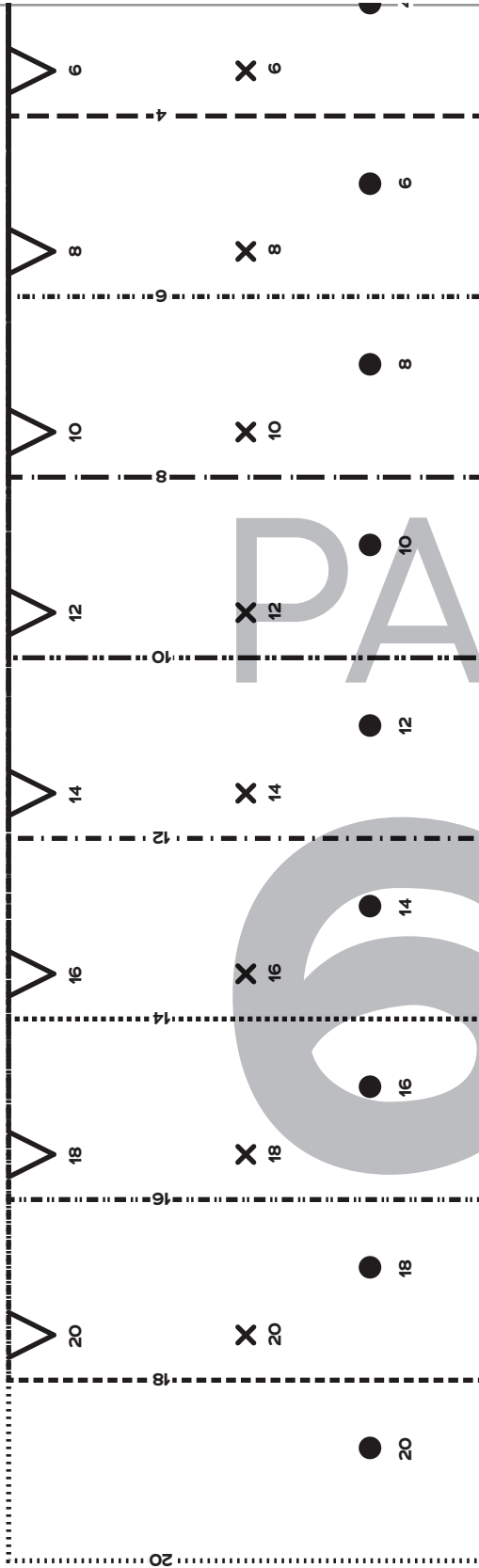

FOLD BACK THIS MARGIN

E1

E2

PAGE

62

FOLD BACK THIS MARGIN

E2

E3

LENGTHEN / SHORTEN LINE

PAGE

63

FOLD BACK THIS MARGIN

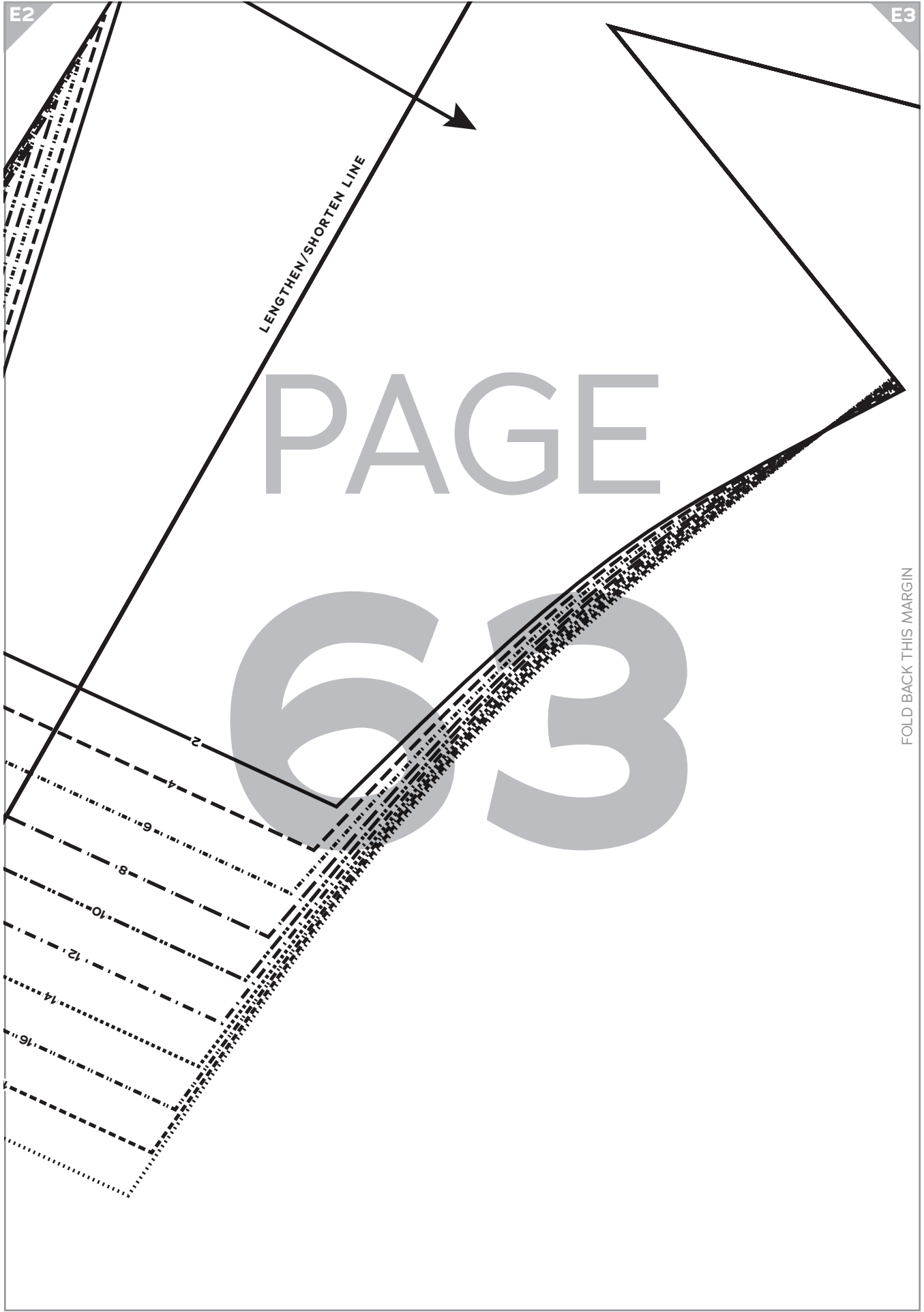

E3

E4

PAGE

64

LENGTHEN/SHORTEN LINE

FOLD BACK THIS MARGIN

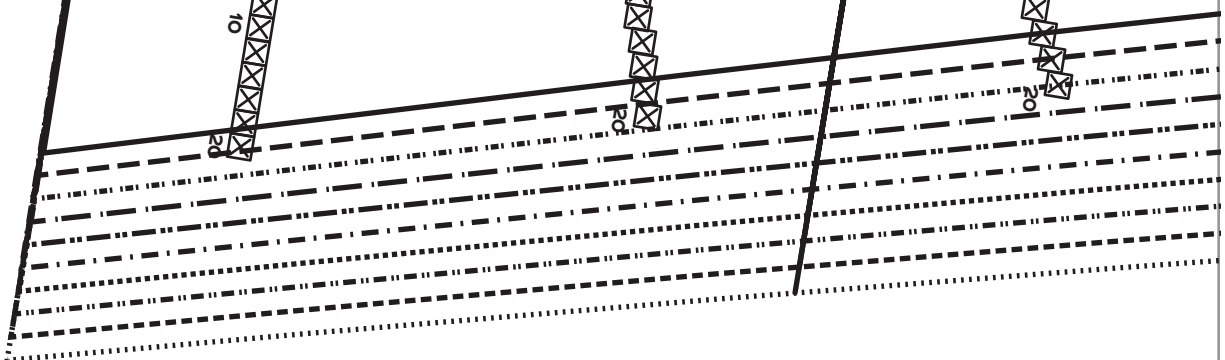
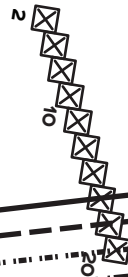
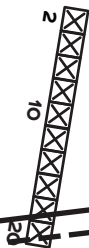

E4

E5

PAGE

GRAINLINE



CHARM SCHOOL
UNIFORM
SIZES 2-20

Bodice Front,
F/G Cup
Cut 2 fabric, 2 lining

FOLD BACK THIS MARGIN

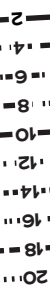
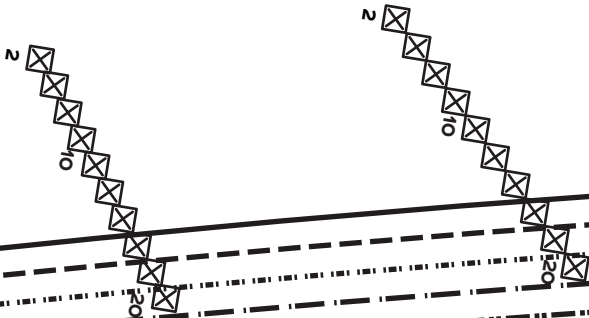

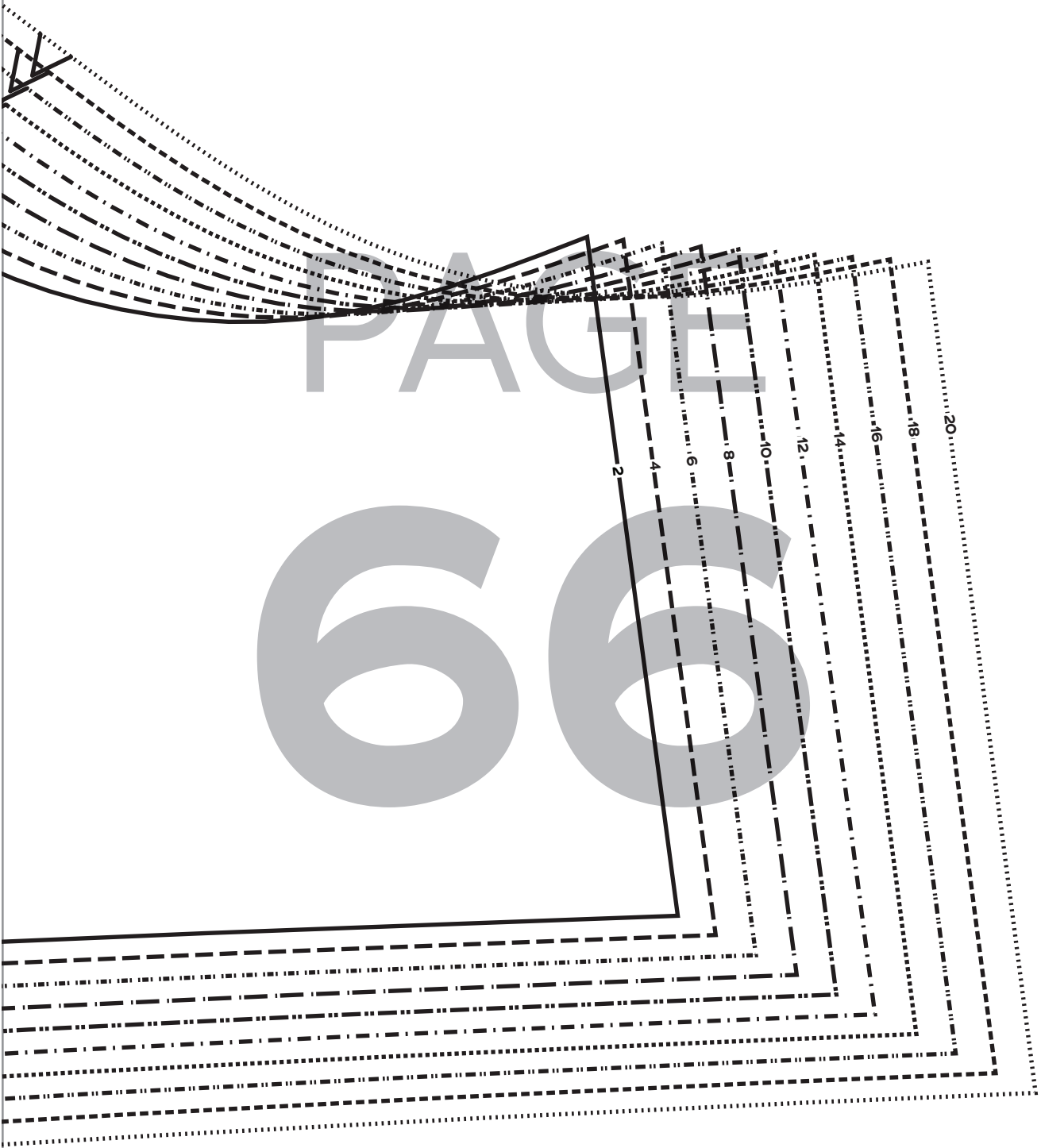

FOLD BACK THIS MARGIN

PAGE 67

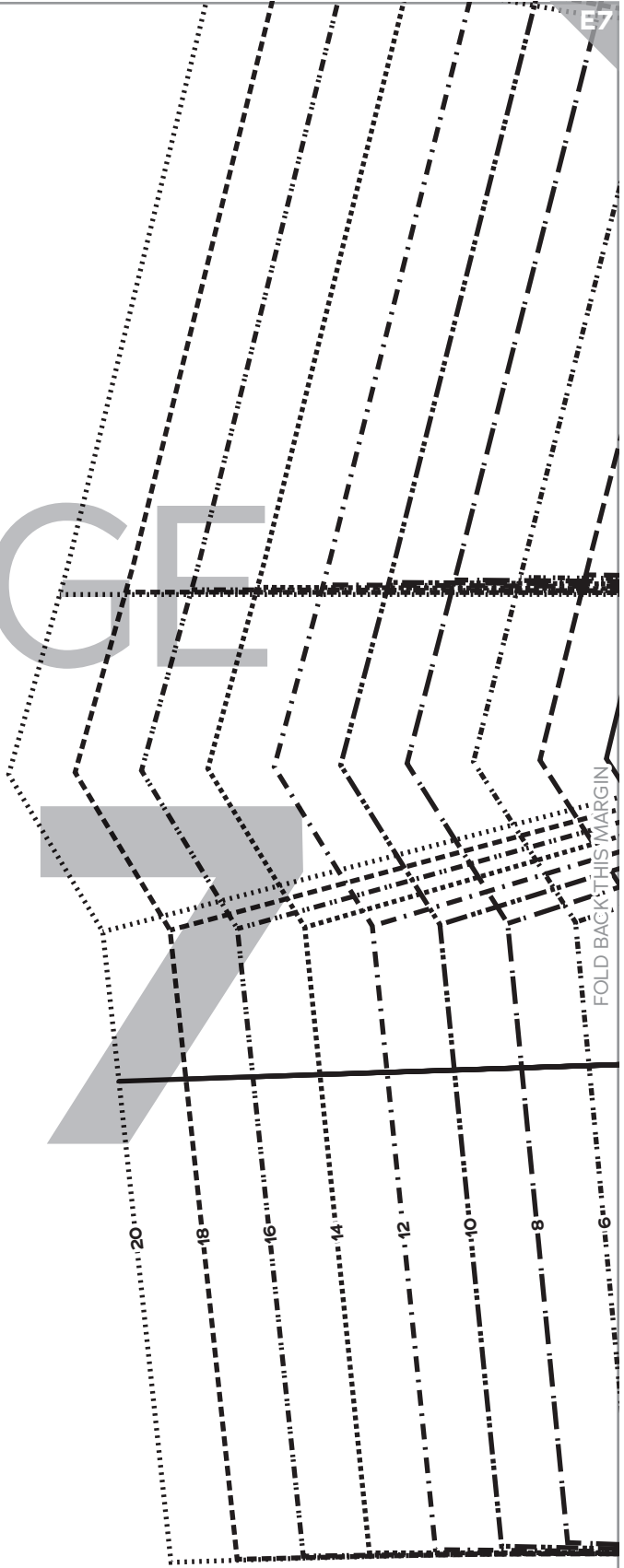

FOLD BACK THIS MARGIN

20 18 16 14 12 10 8 6

E7

E8

Charm School
BY GERTIE

1 CHARM SCHOOL
UNIFORM
SIZES 2-20

Bodice Front,
D/DD Cup
Cut 2 fabric, 2 lining

PAGE

68

LENGTHEN/SHORTEN LINE

FOLD BACK THIS MARGIN

4"

2

GRAINLINE

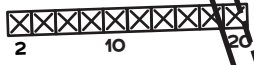
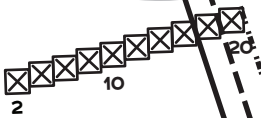
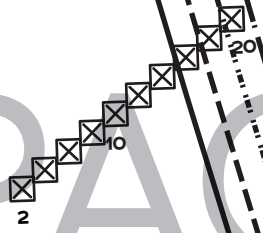
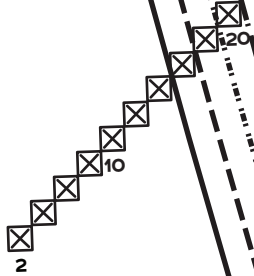

PAGE

69

FOLD BACK THIS MARGIN

PAGE 70

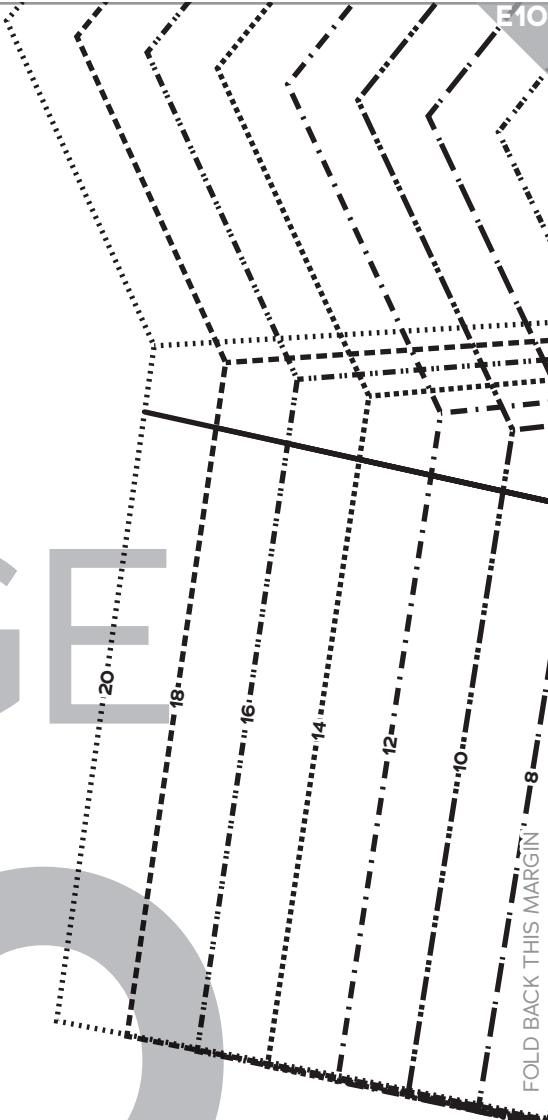

E10

E11

PAGE

71

LENGTHEN/SHORTEN LINE

FOLD BACK THIS MARGIN

6"

4"

2

GRAINLINE

PAGE

72

